



A Project of FIMS SCHOOLS
WORKSHEET POINT
www.worksheetpoint.com

Name: _____

Date: _____

Grade: _____

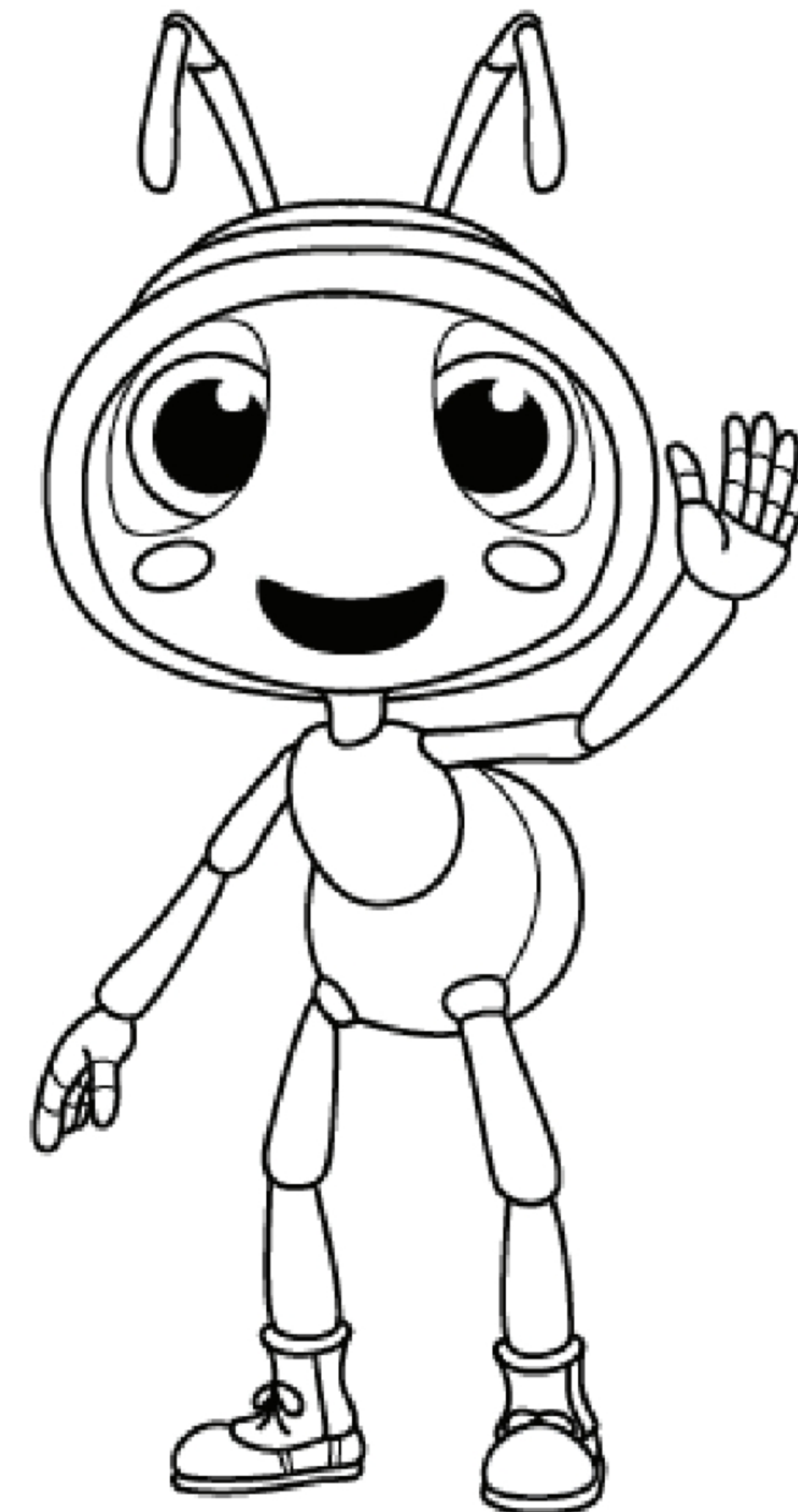
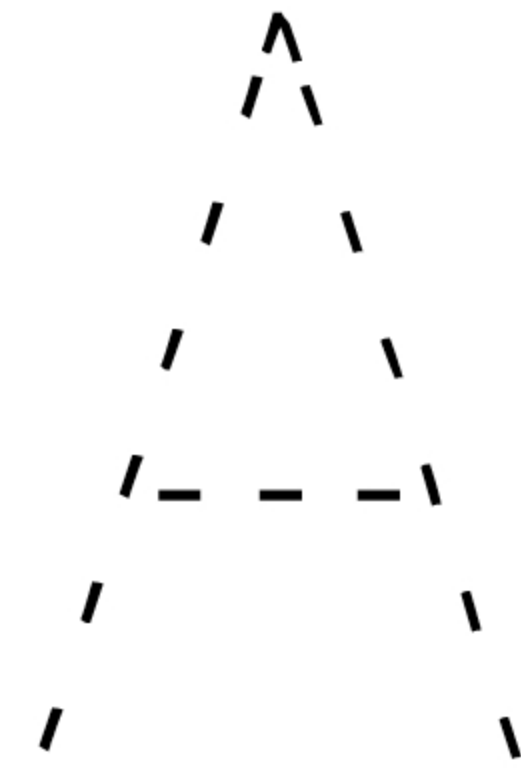
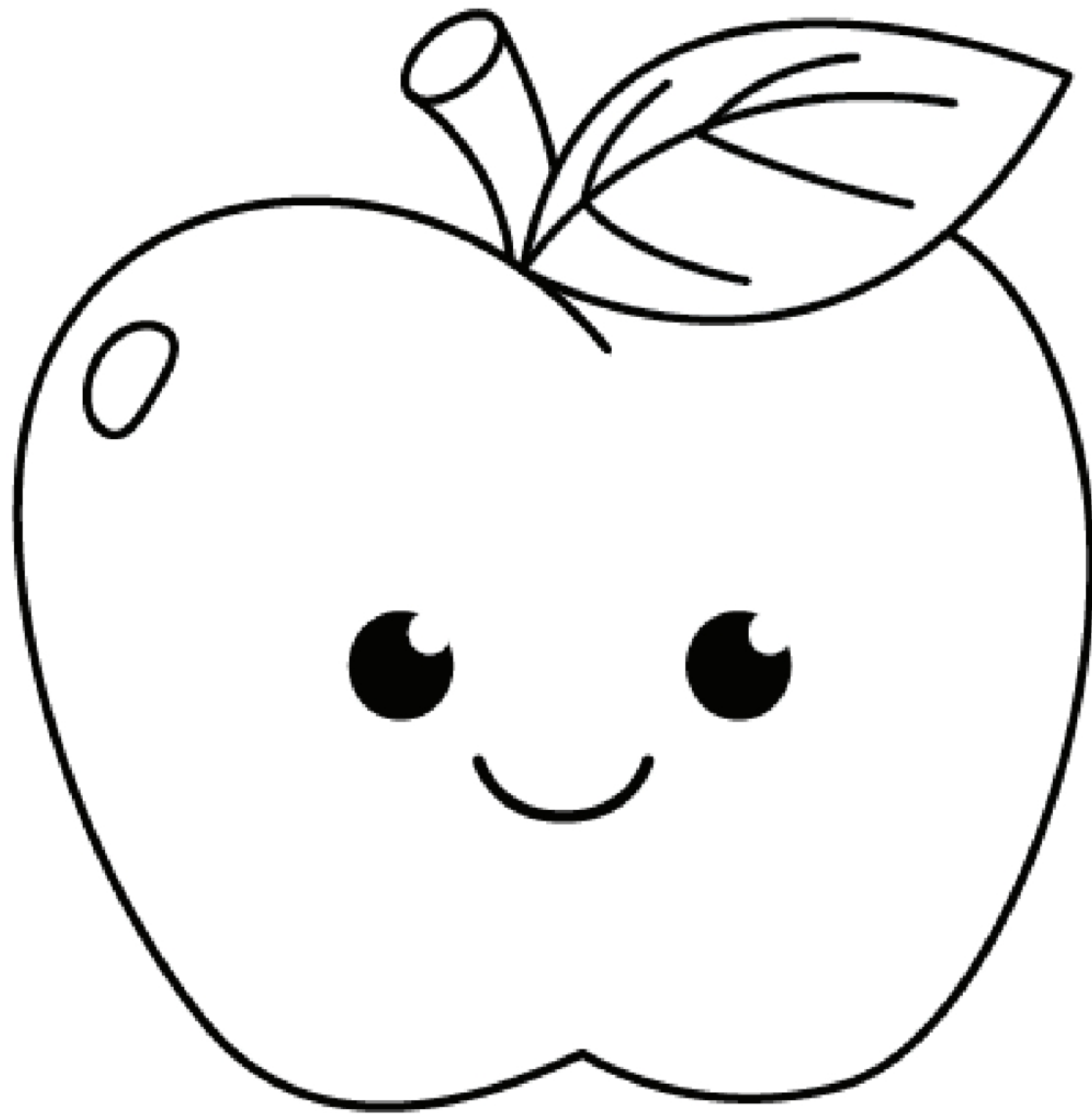

A P P P L E

A N T



A Project of FIMS SCHOOLS
WORKSHEET POINT
www.worksheetpoint.com

Name: _____

Date: _____

Grade: _____

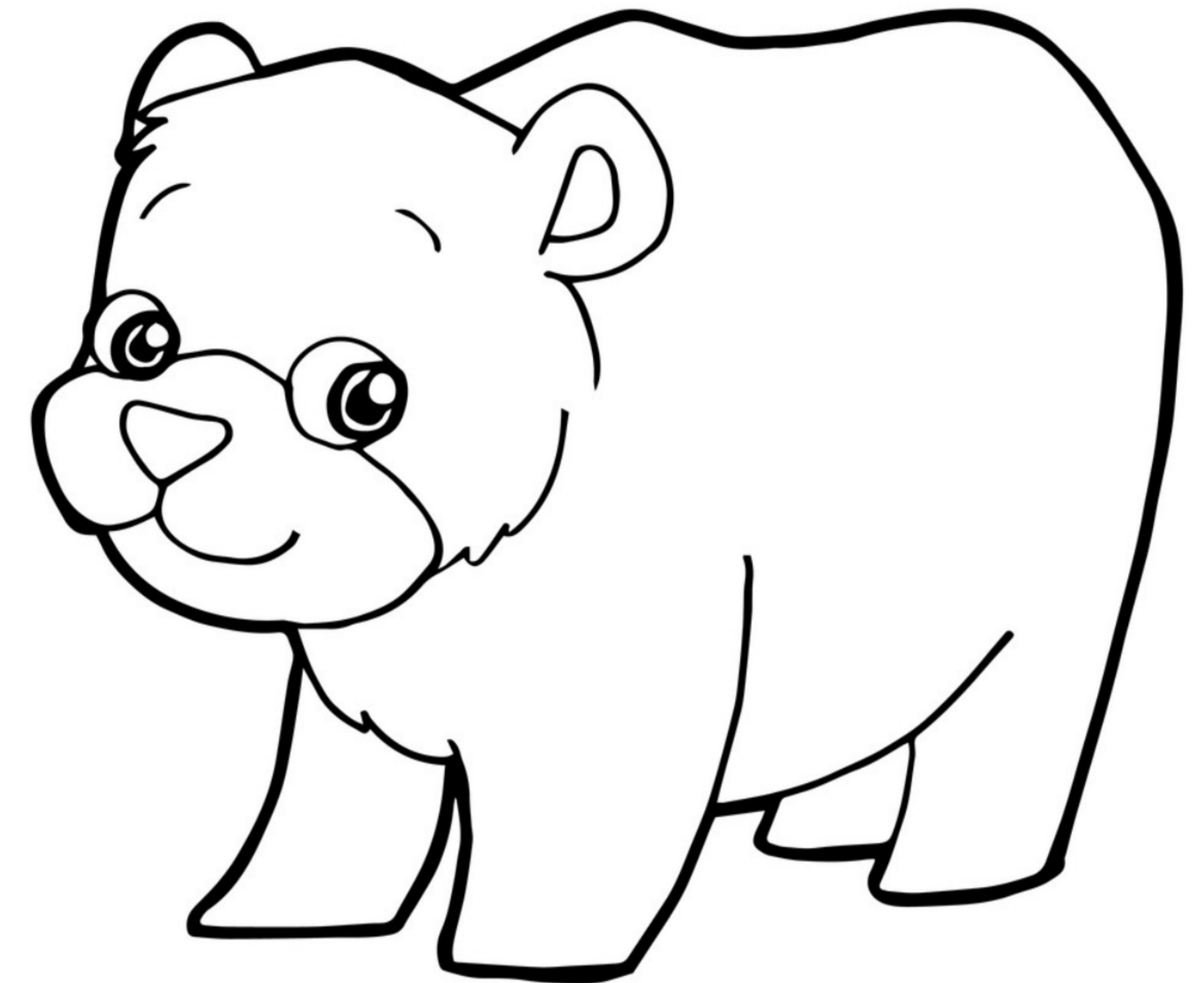
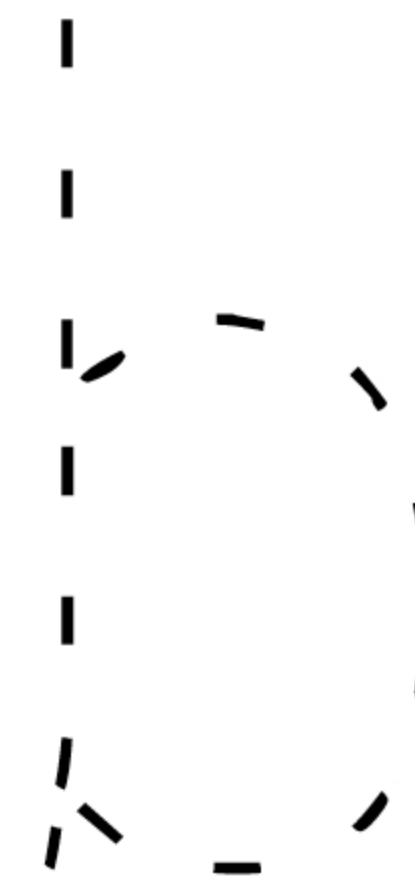
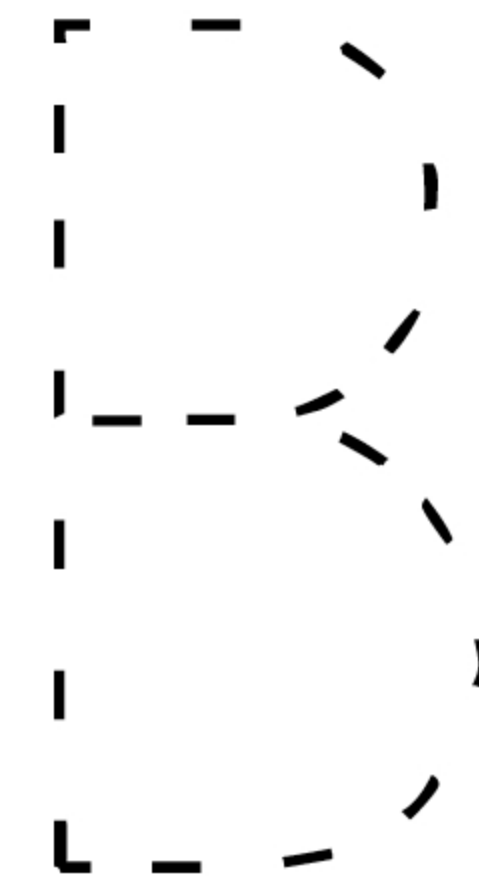
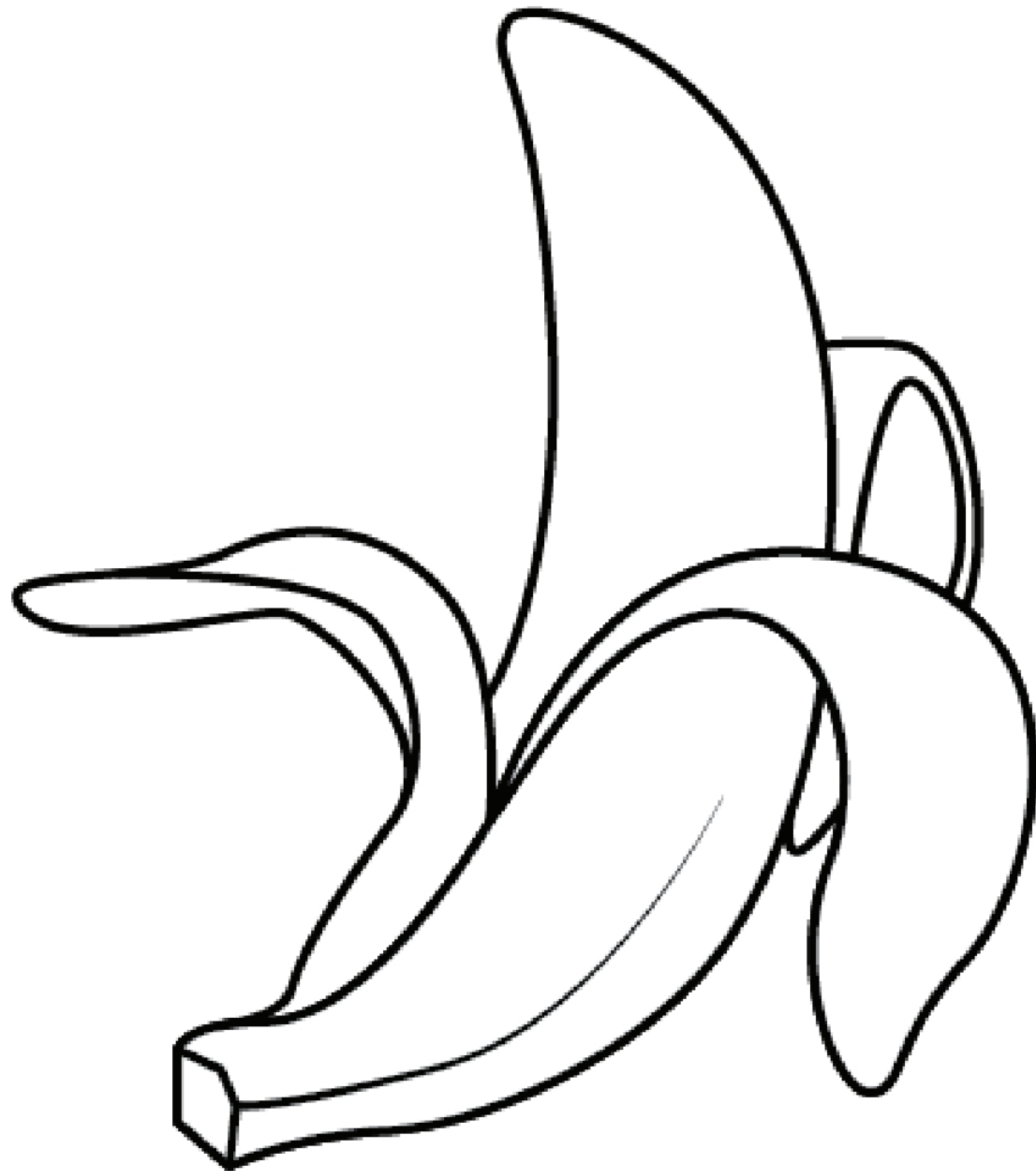

BANANA

BEAR



A Project of FIMS SCHOOLS
WORKSHEET POINT
www.worksheetpoint.com

Name: _____

Date: _____

Grade: _____

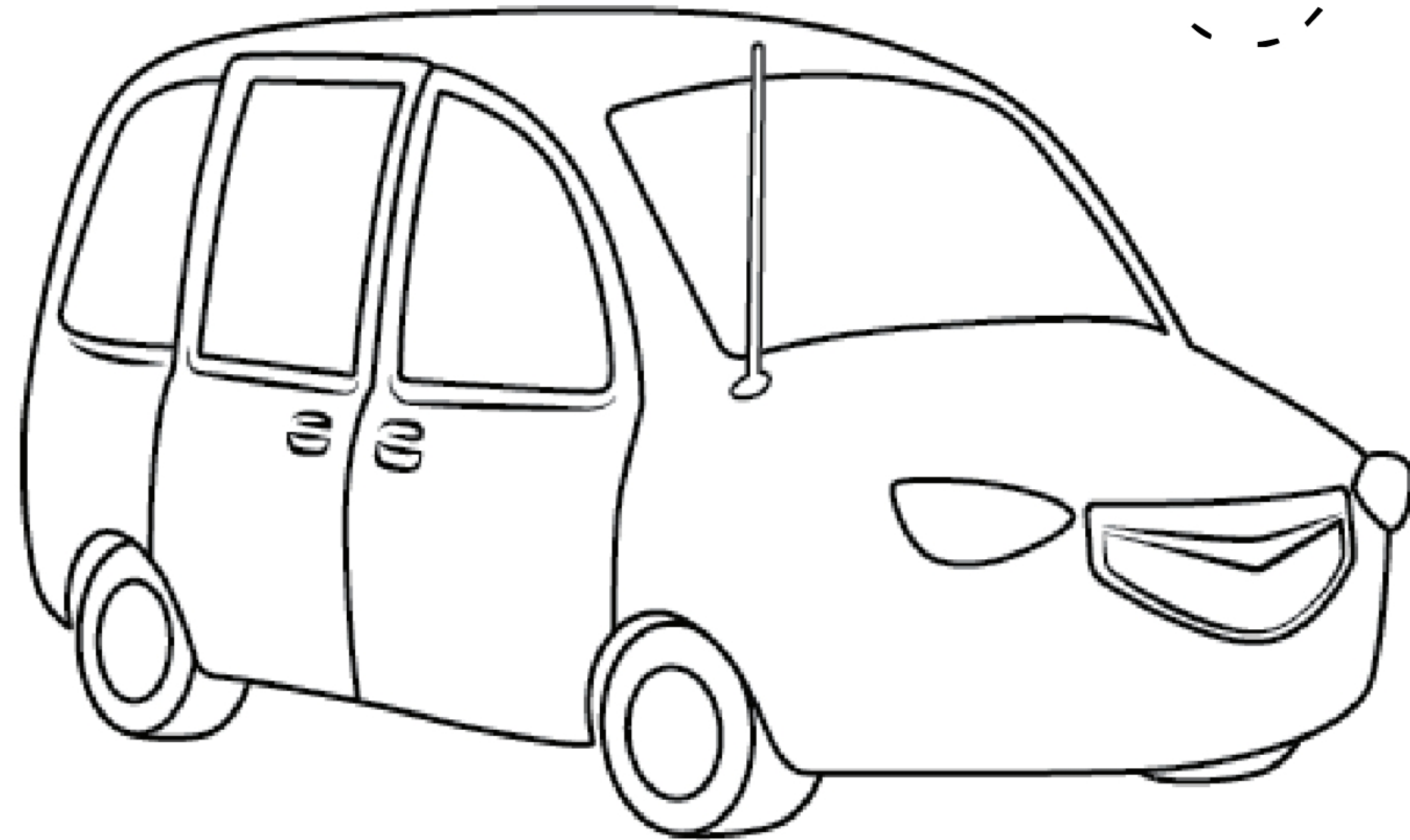

○ CAR

○ CAT



A Project of FIMS SCHOOLS
WORKSHEET POINT
www.worksheetpoint.com

Name: _____

Date: _____

Grade: _____

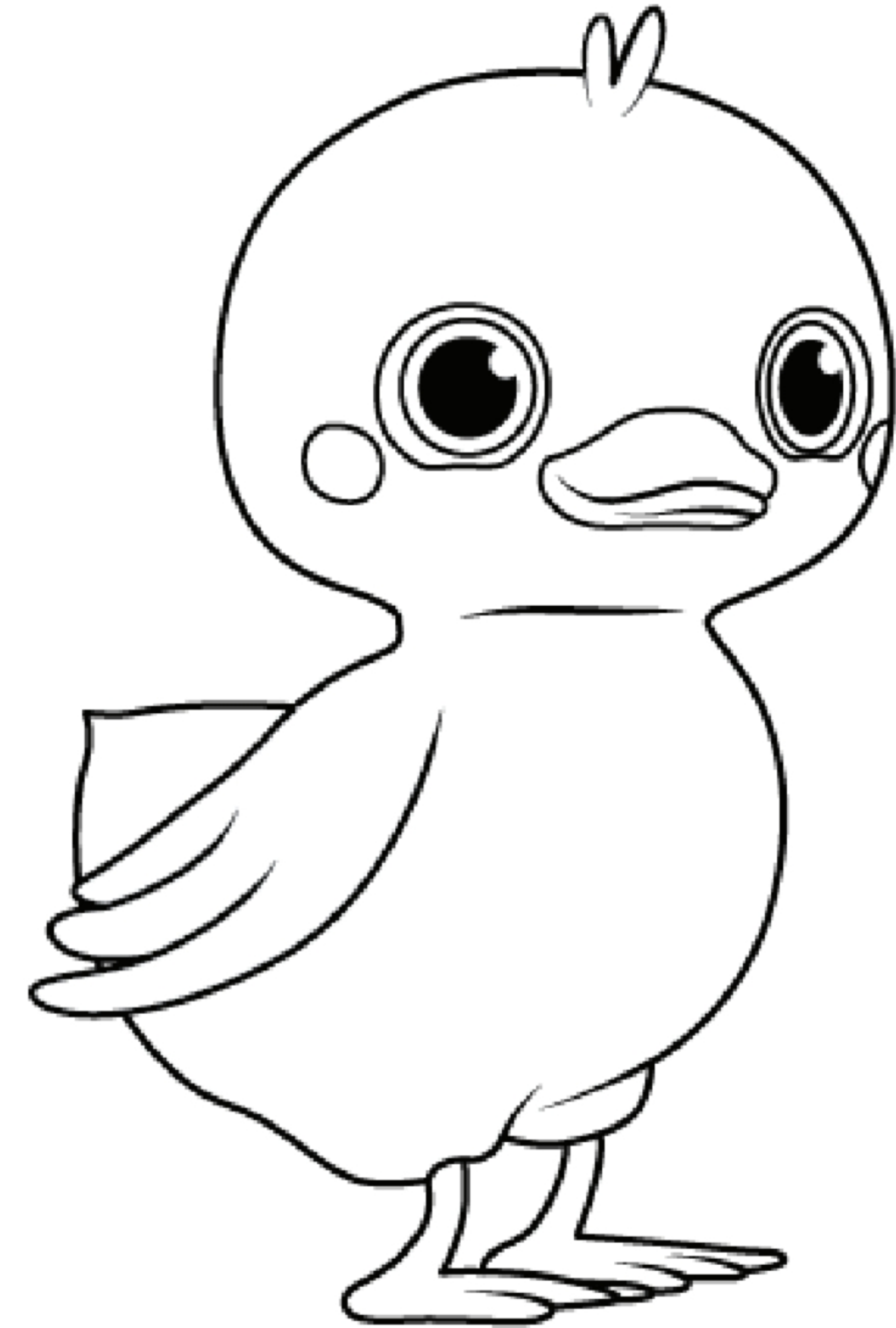
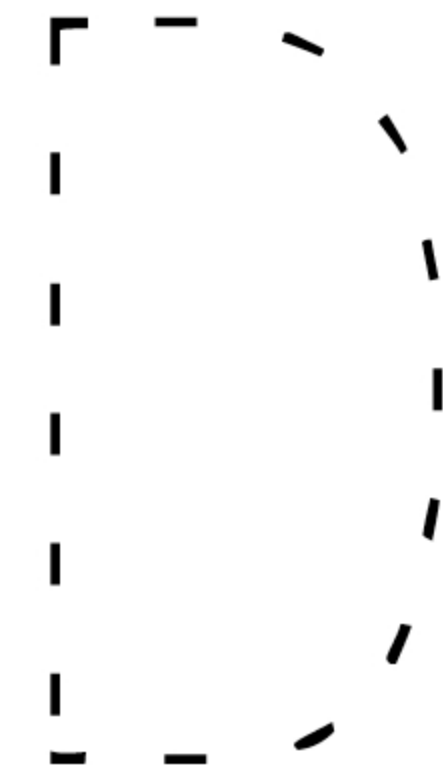
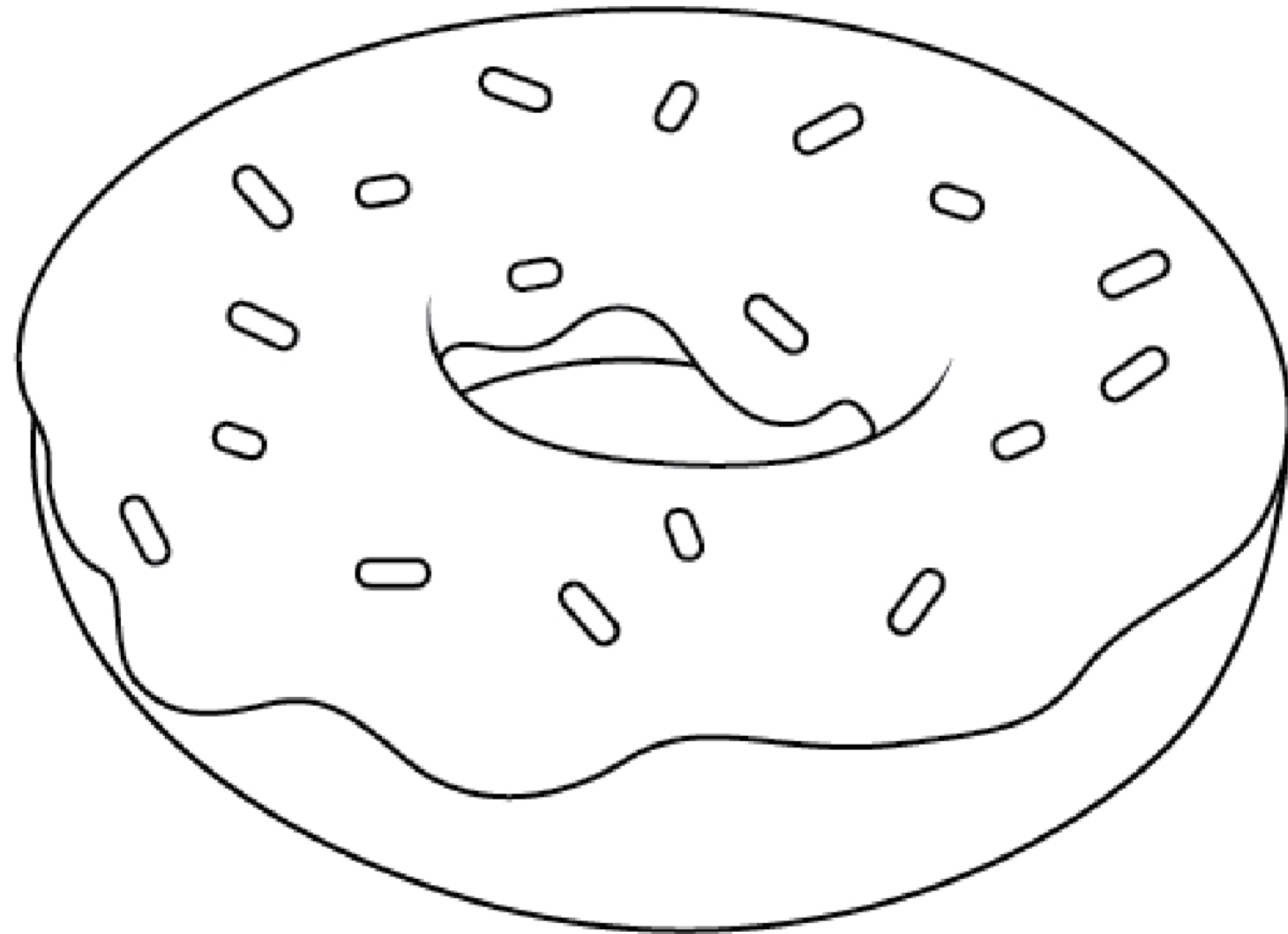

D DONUT

D DUCK



A Project of FIMS SCHOOLS
WORKSHEET POINT
www.worksheetpoint.com

Name: _____

Date: _____

Grade: _____

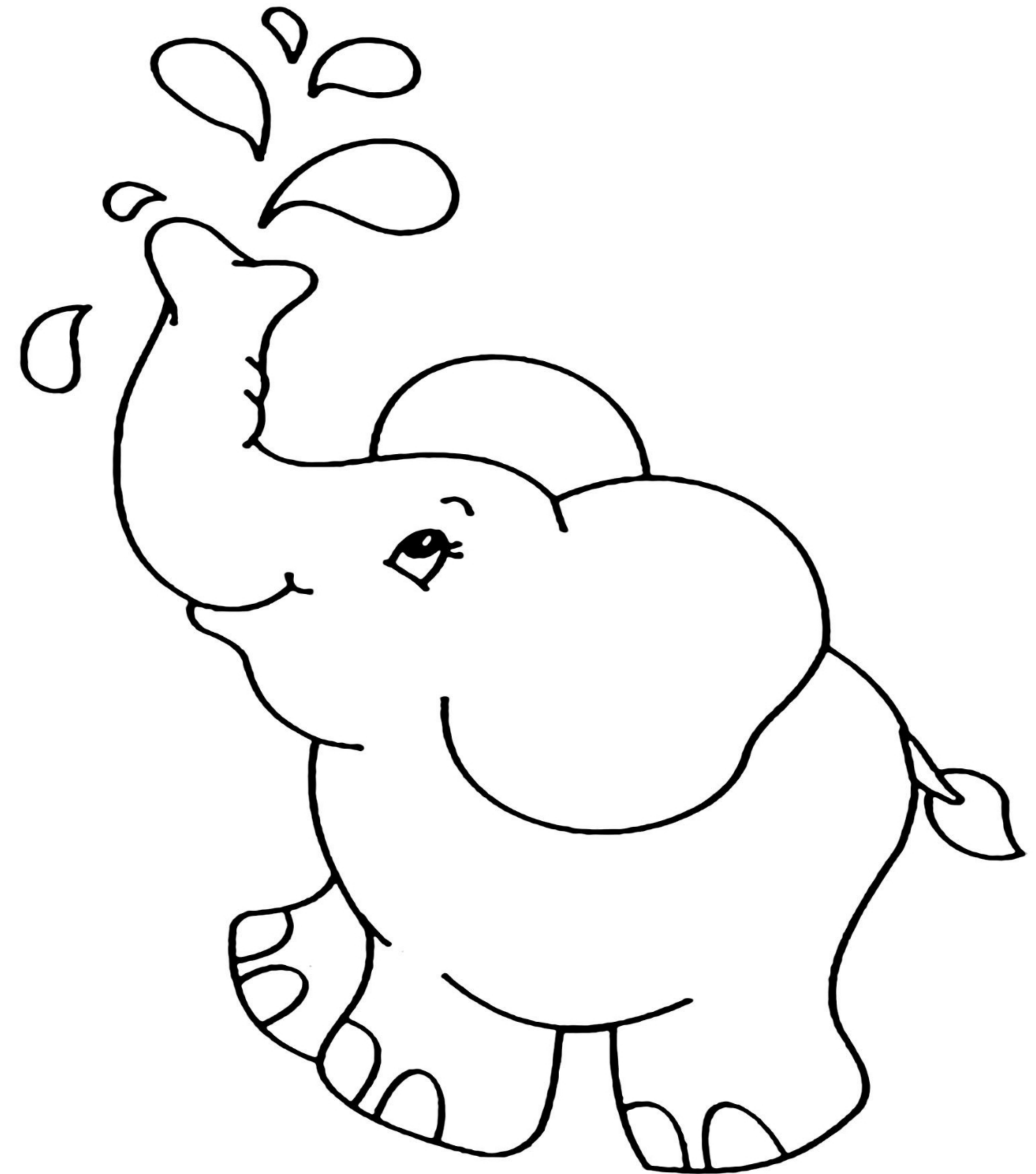
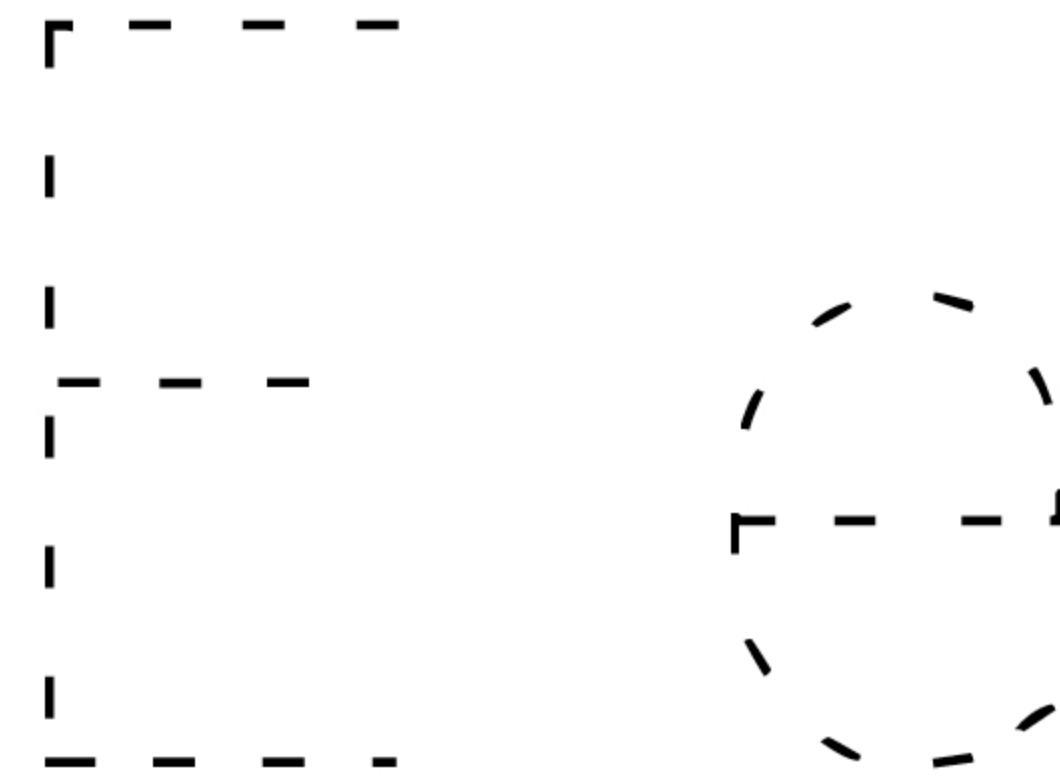
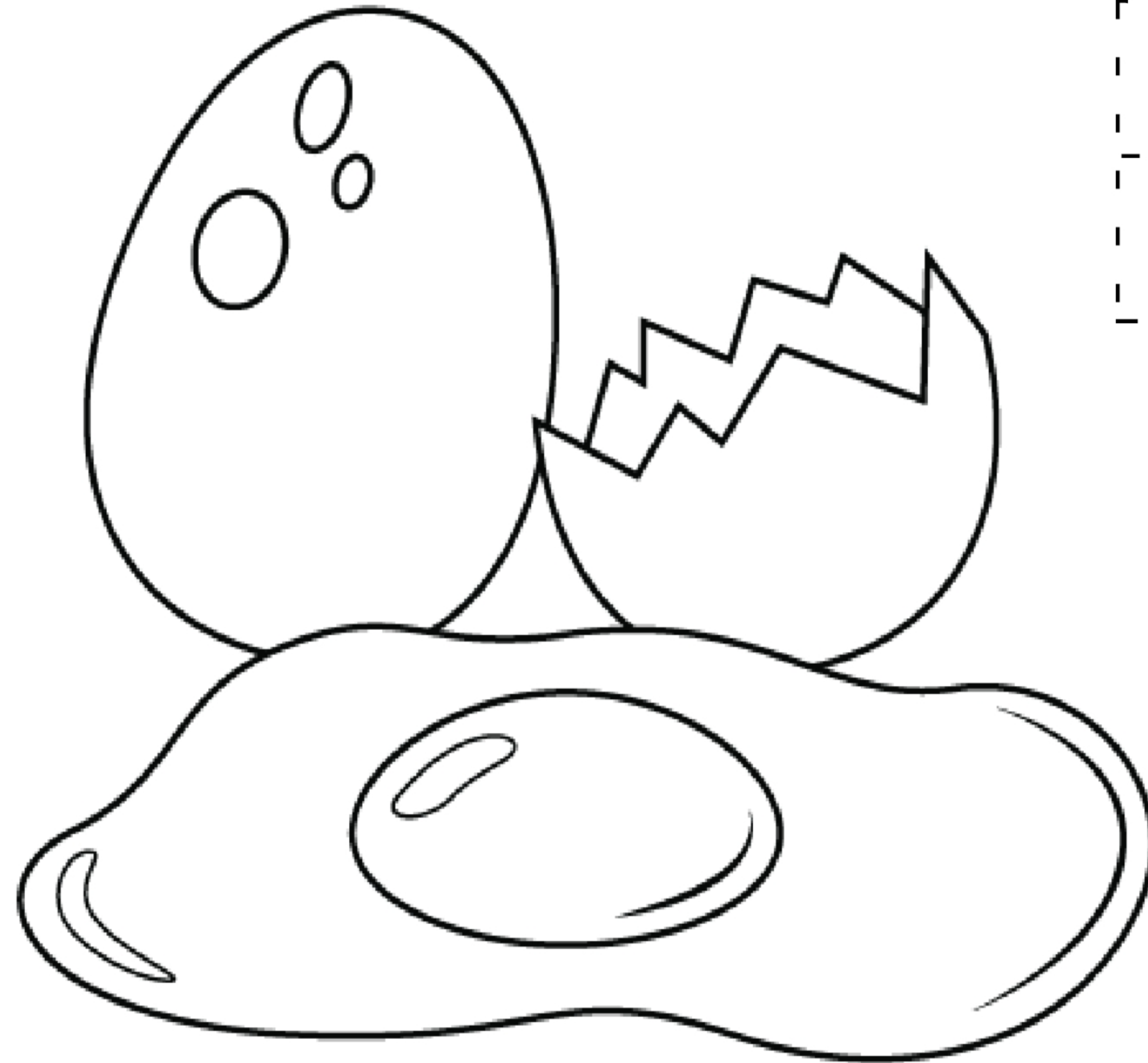

E G G

E LEPHANT



A Project of FIMS SCHOOLS
WORKSHEET POINT
www.worksheetpoint.com

Name: _____

Date: _____

Grade: _____

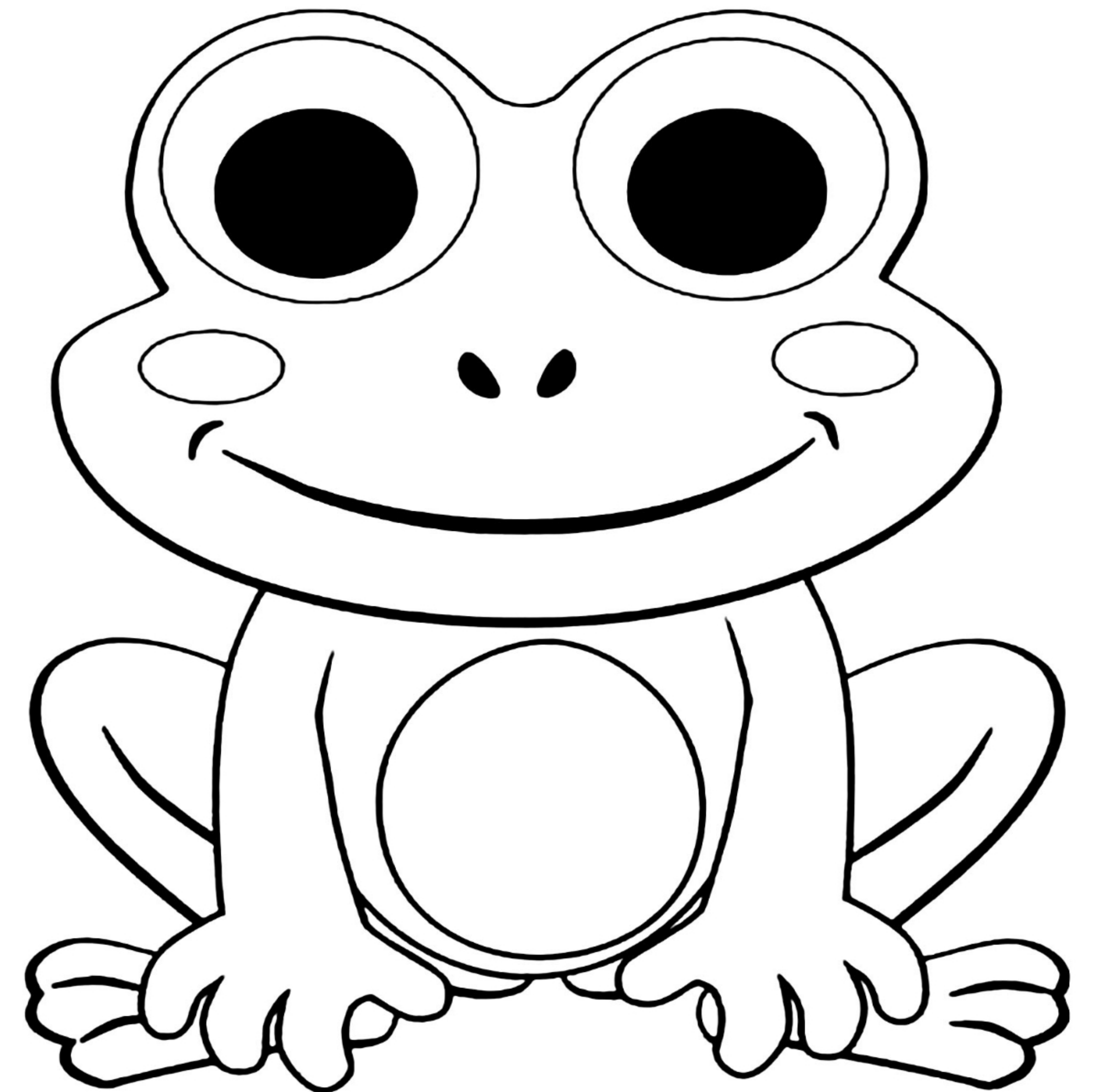
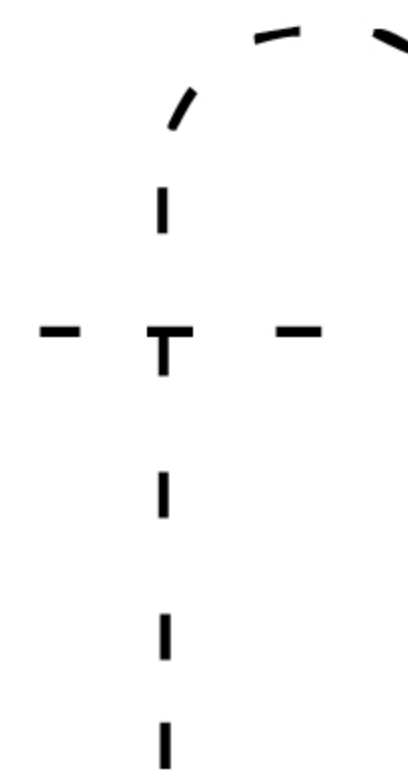
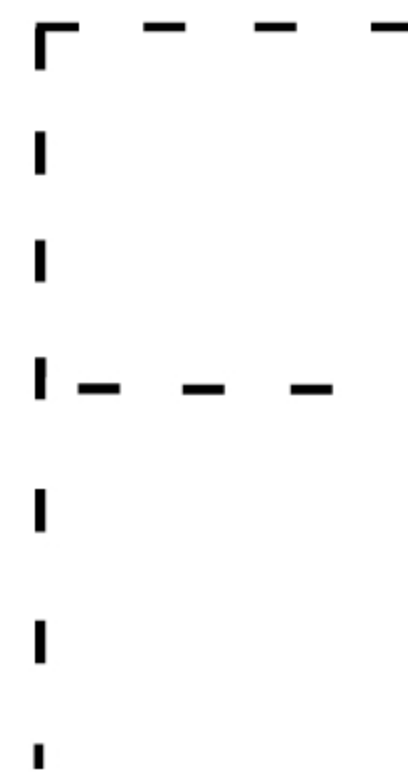
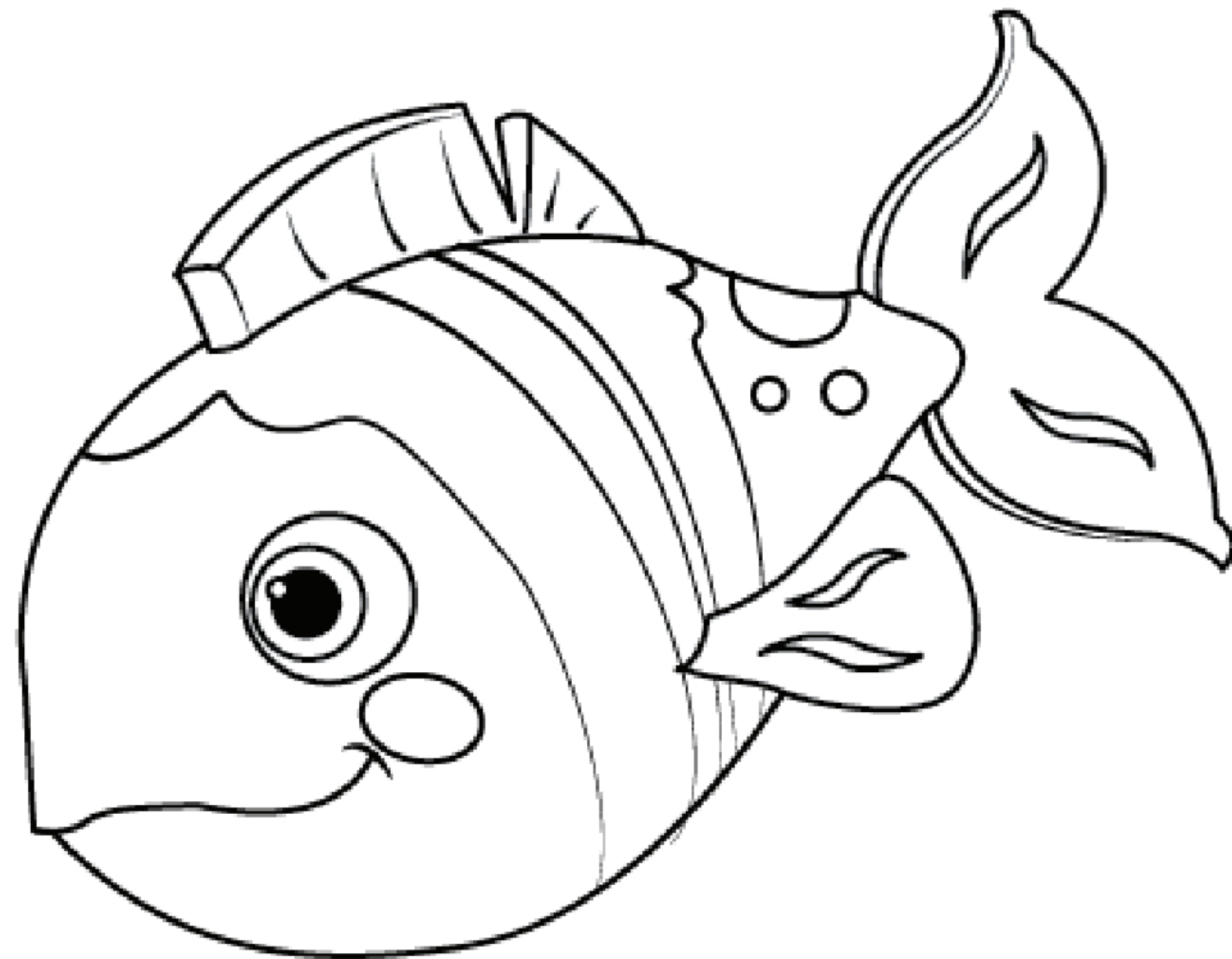

FISH

FROG



A Project of FIMS SCHOOLS
WORKSHEET POINT
www.worksheetpoint.com

Name: _____

Date: _____

Grade: _____

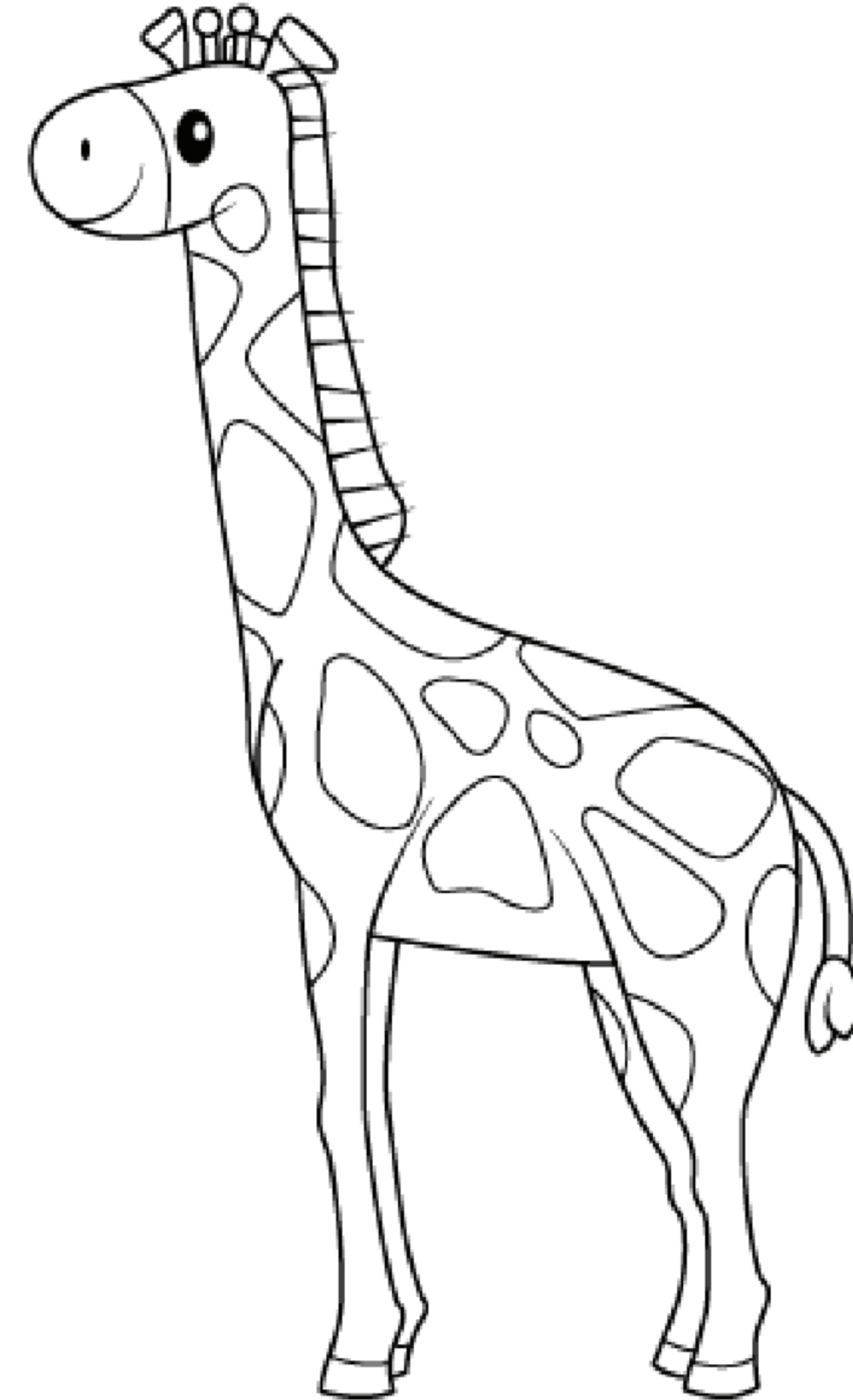
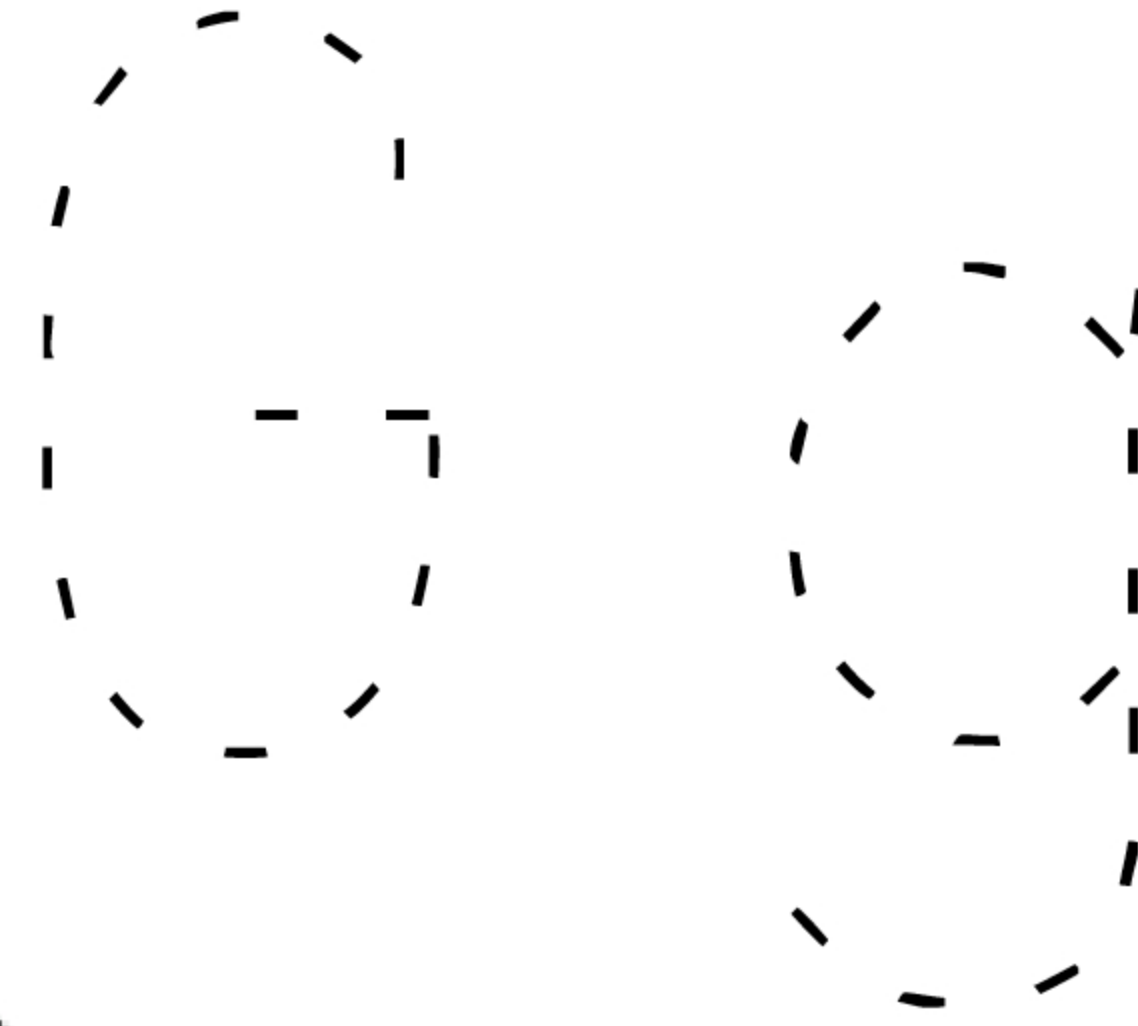
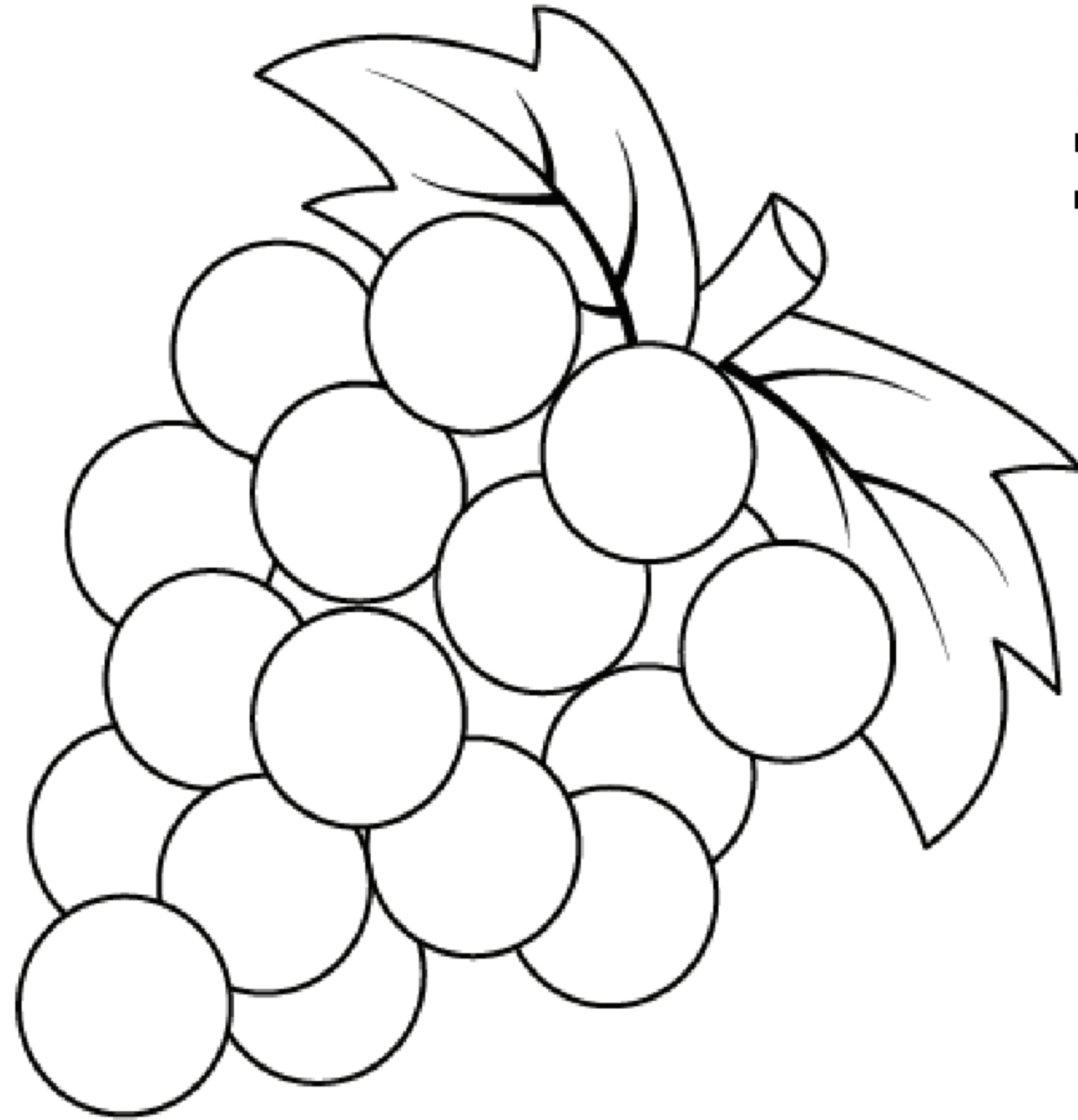

 GRAPE

 GIRAFFE



A Project of FIMS SCHOOLS
WORKSHEET POINT
www.worksheetpoint.com

Name: _____

Date: _____

Grade: _____

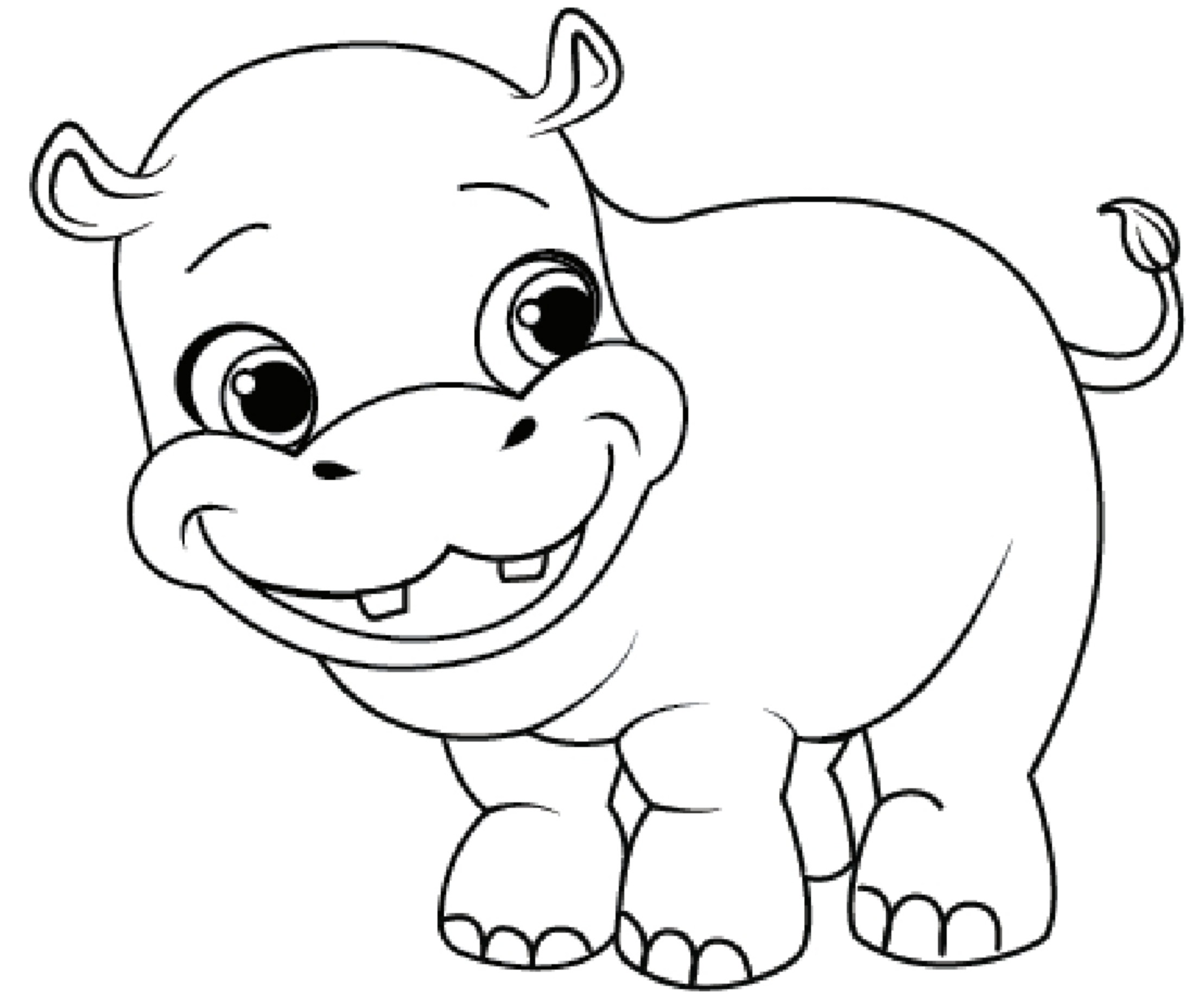
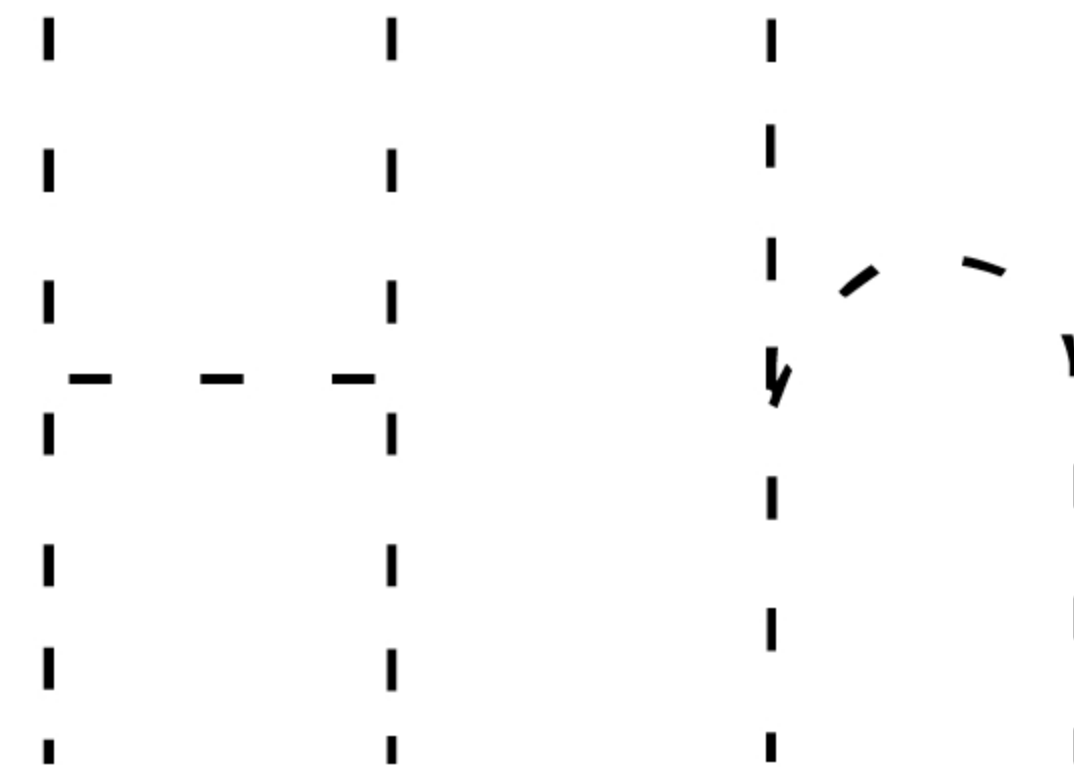

HOUSE

HIPPO



A Project of FIMS SCHOOLS
WORKSHEET POINT
www.worksheetpoint.com

Name: _____

Date: _____

Grade: _____

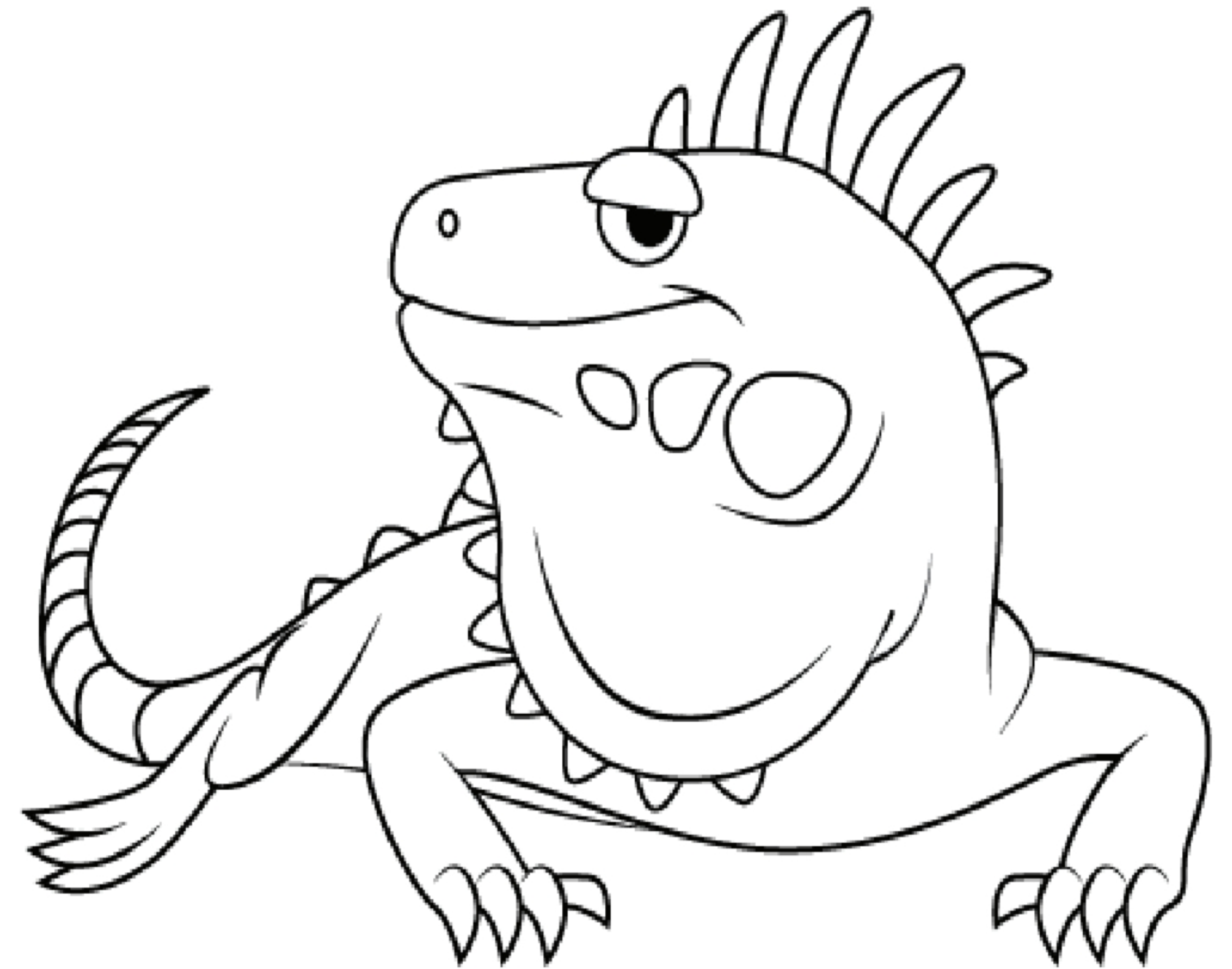
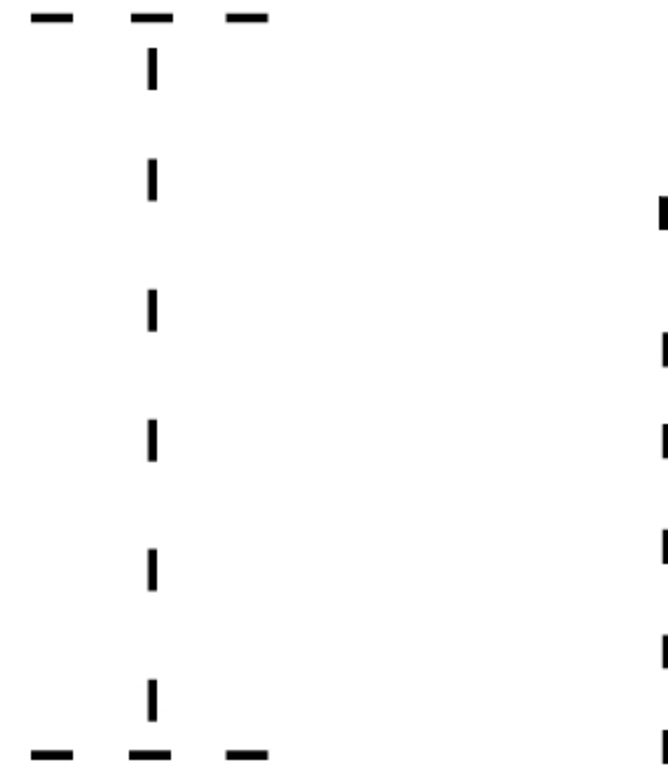

I CE CREAM

I GUANA

Get Pdf file: www.worksheetpoint.com



A Project of FIMS SCHOOLS
WORKSHEET POINT
www.worksheetpoint.com

Name: _____

Date: _____

Grade: _____

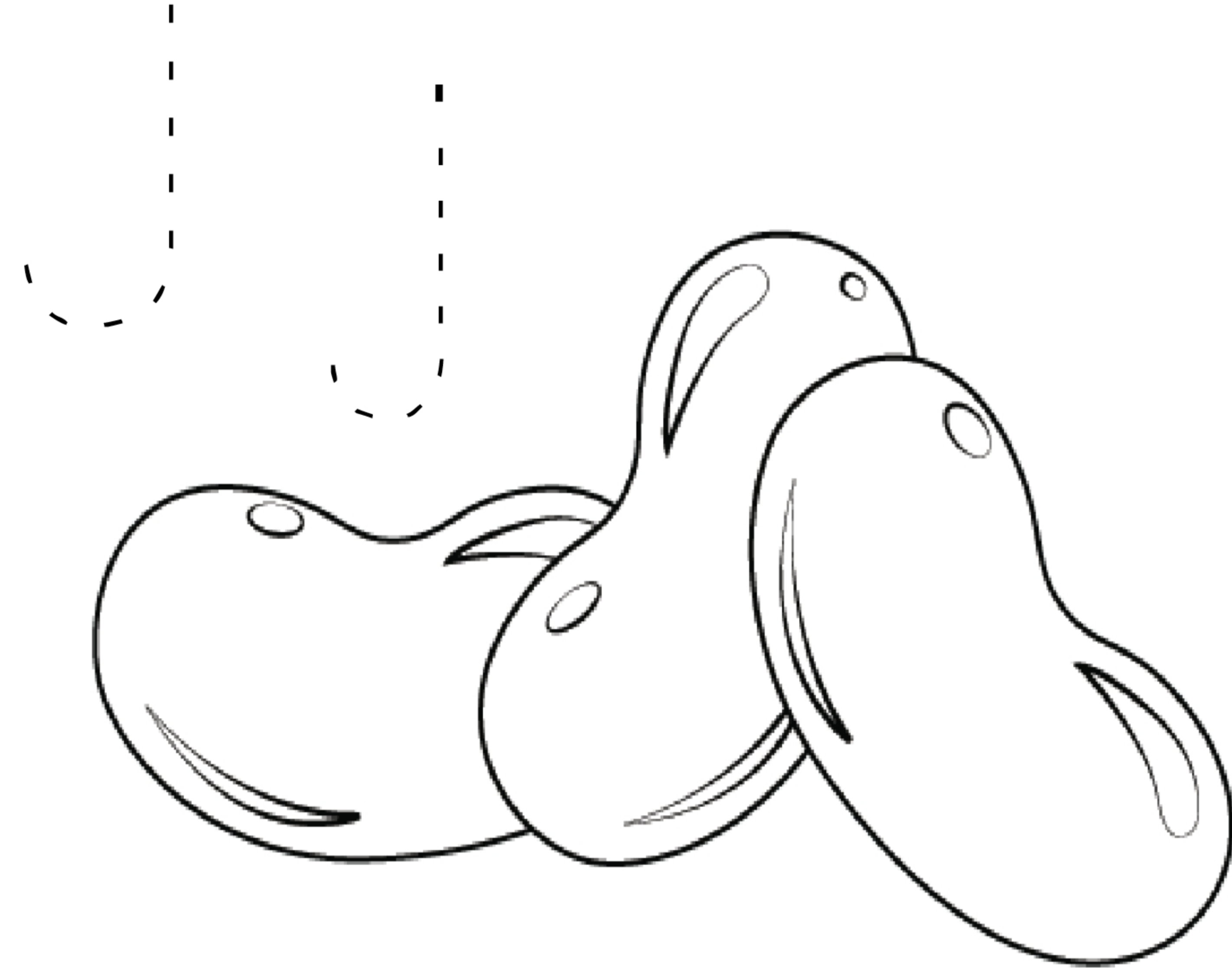
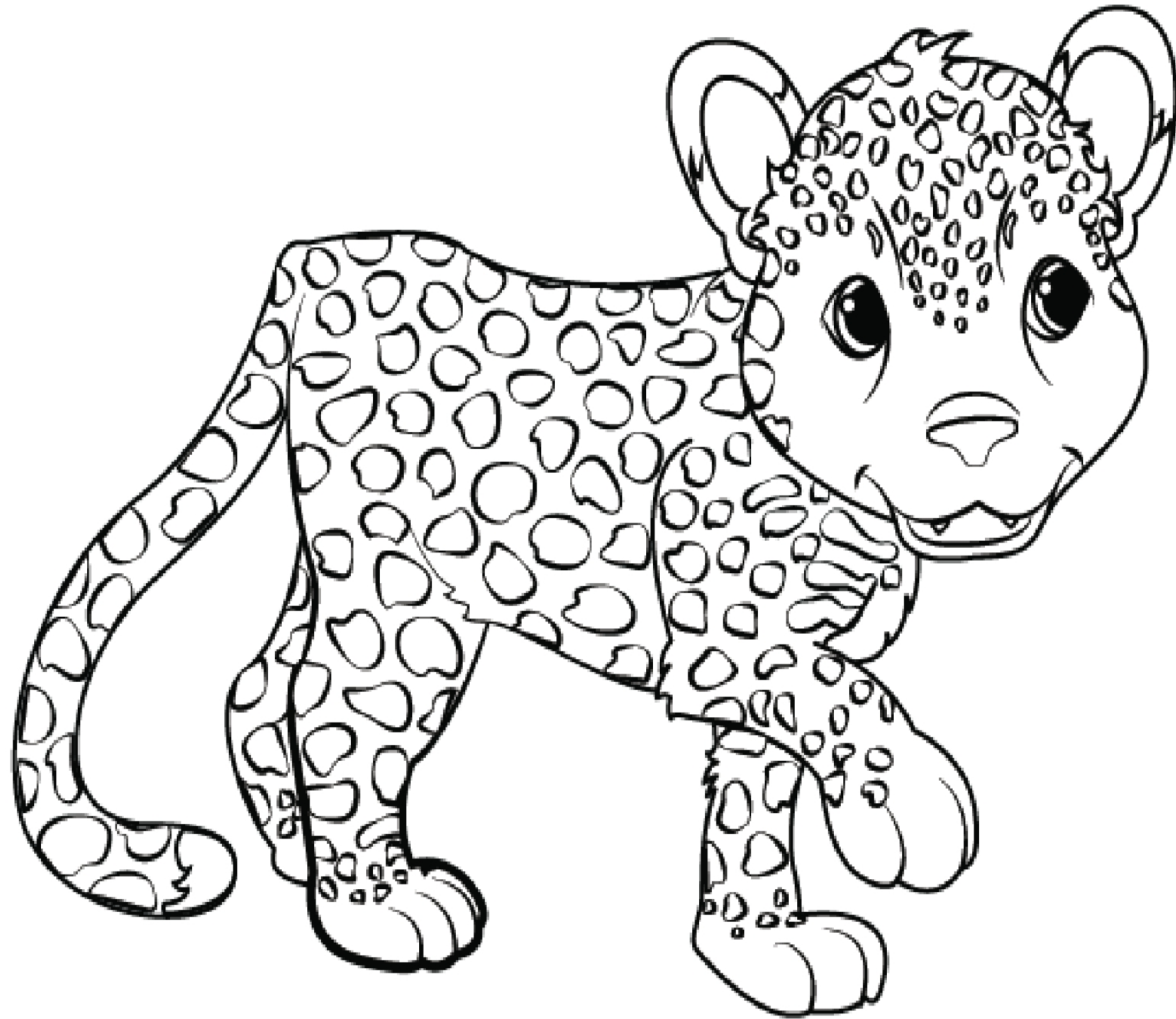

JAGUAR

JELLYBEAN



A Project of FIMS SCHOOLS
WORKSHEET POINT
www.worksheetpoint.com

Name: _____

Date: _____

Grade: _____

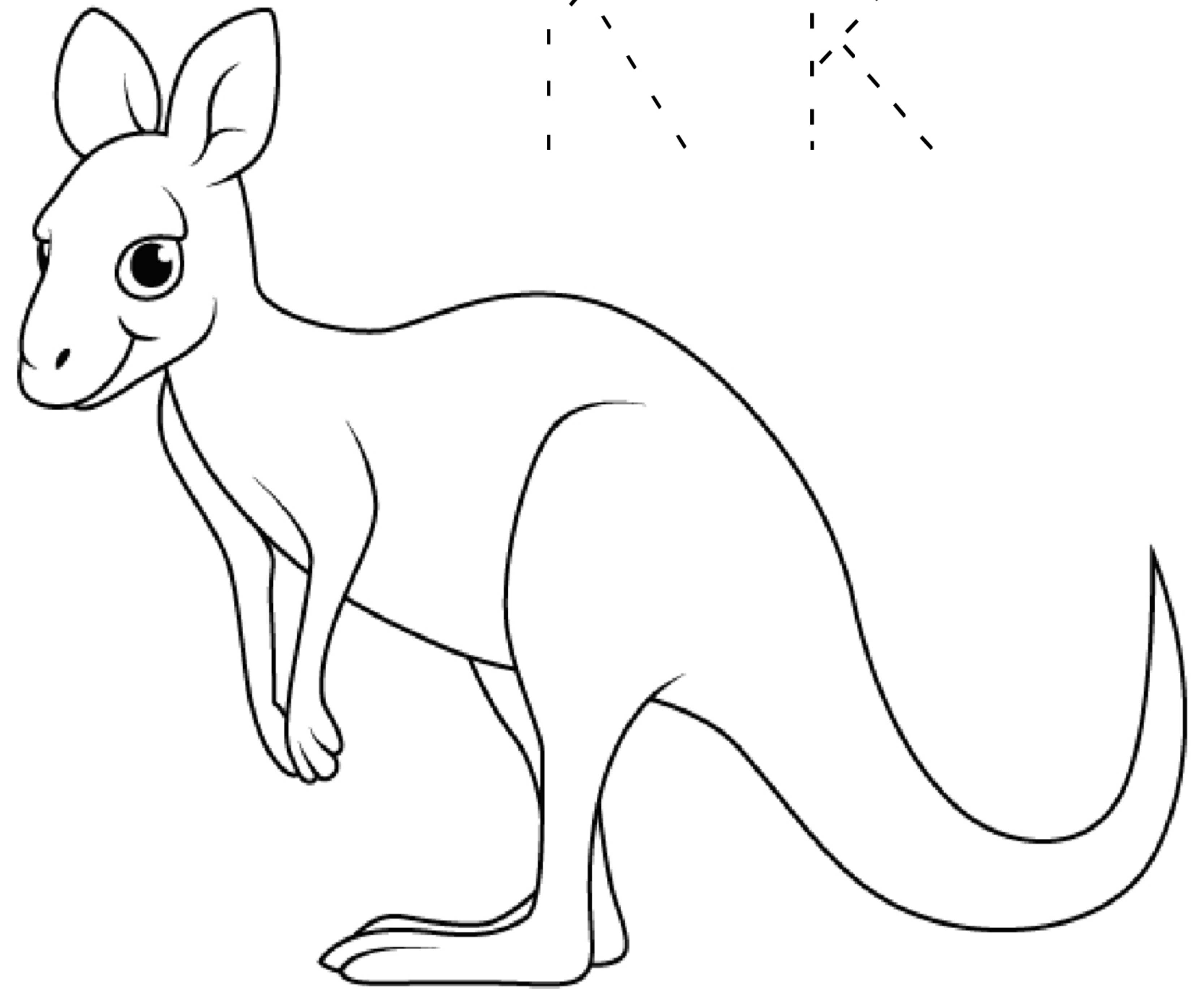
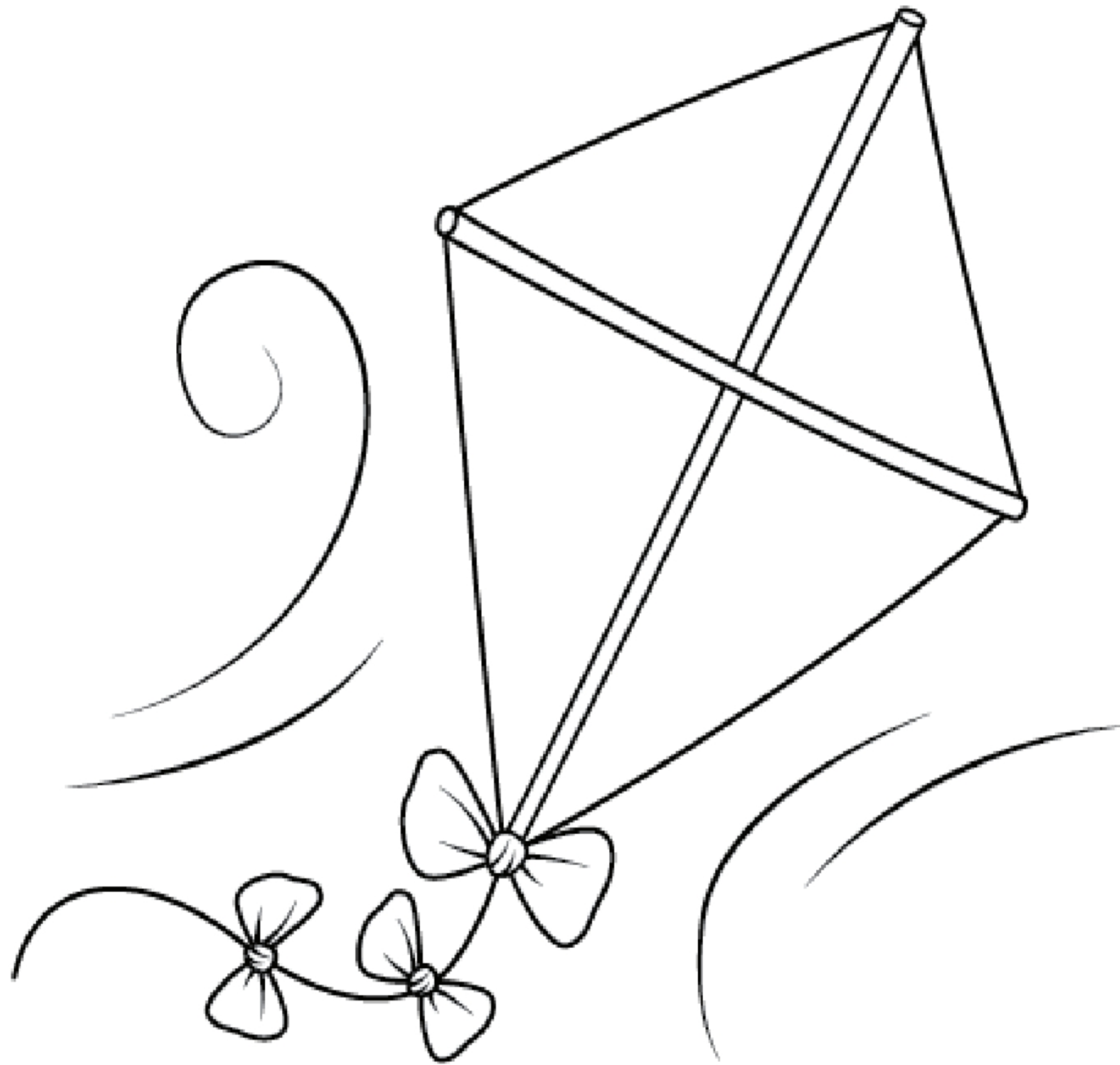

KITE

KANGAROO



A Project of FIMS SCHOOLS
WORKSHEET POINT
www.worksheetpoint.com

Name: _____

Date: _____

Grade: _____

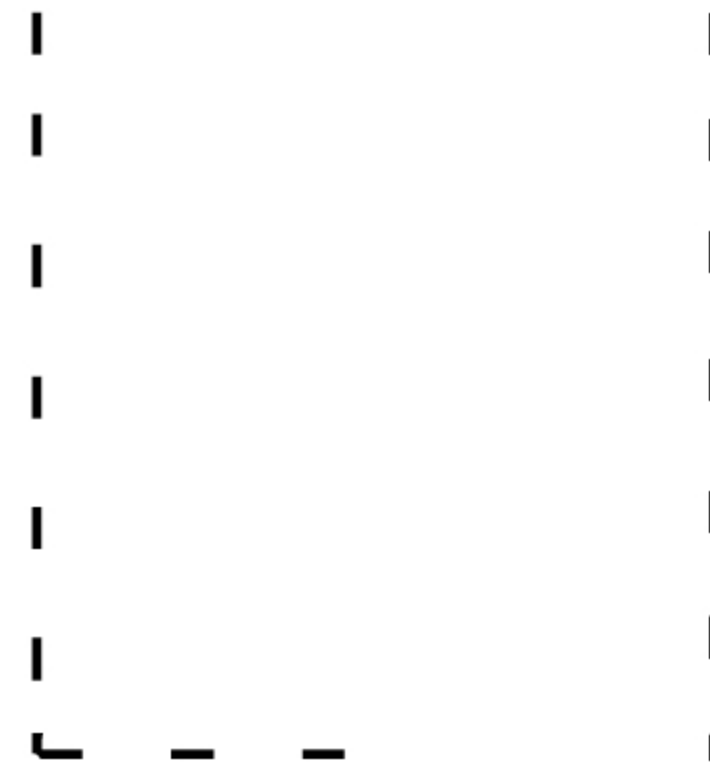
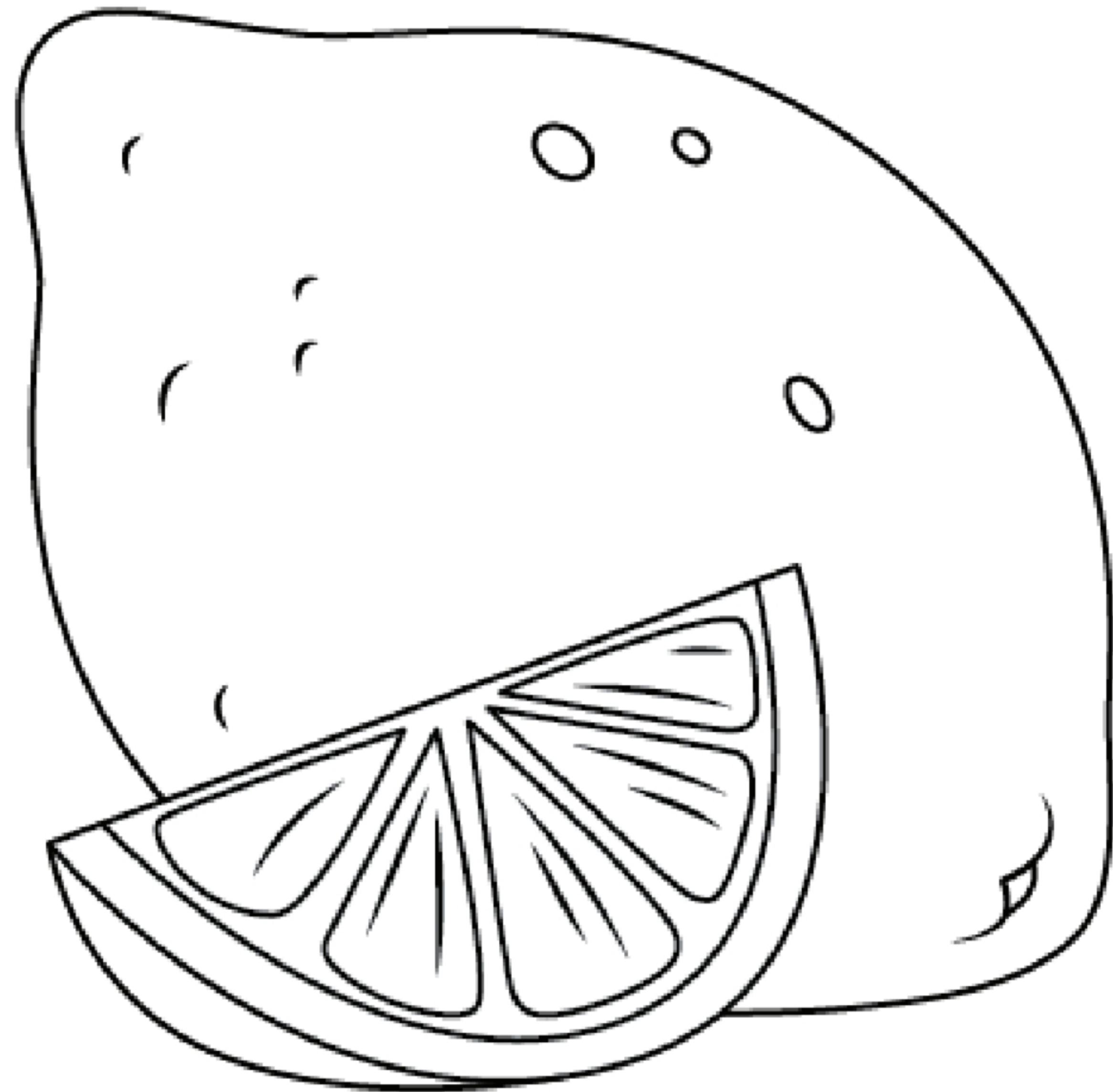

LEMON

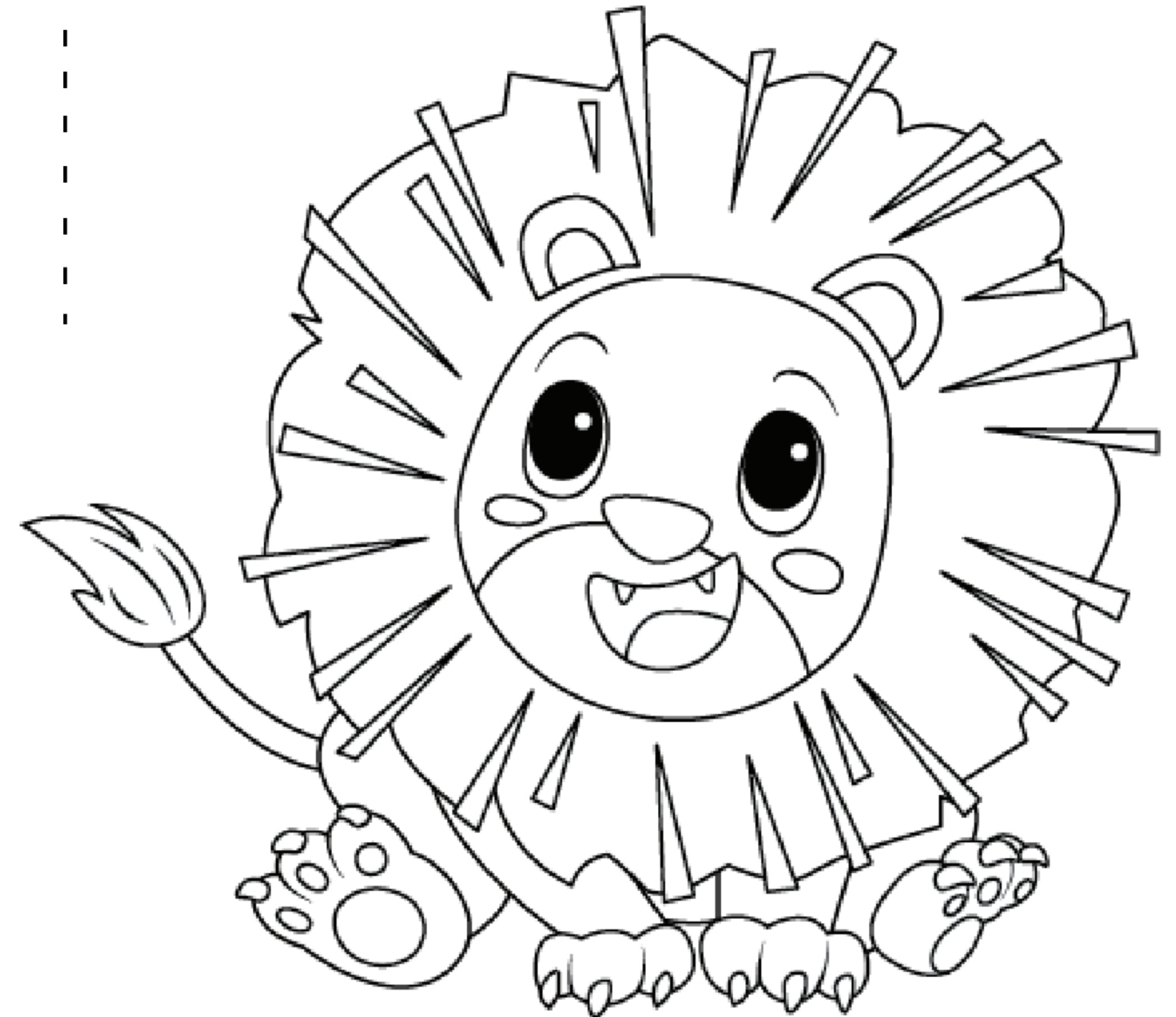

LION



A Project of FIMS SCHOOLS
WORKSHEET POINT
www.worksheetpoint.com

Name: _____

Date: _____

Grade: _____



M m

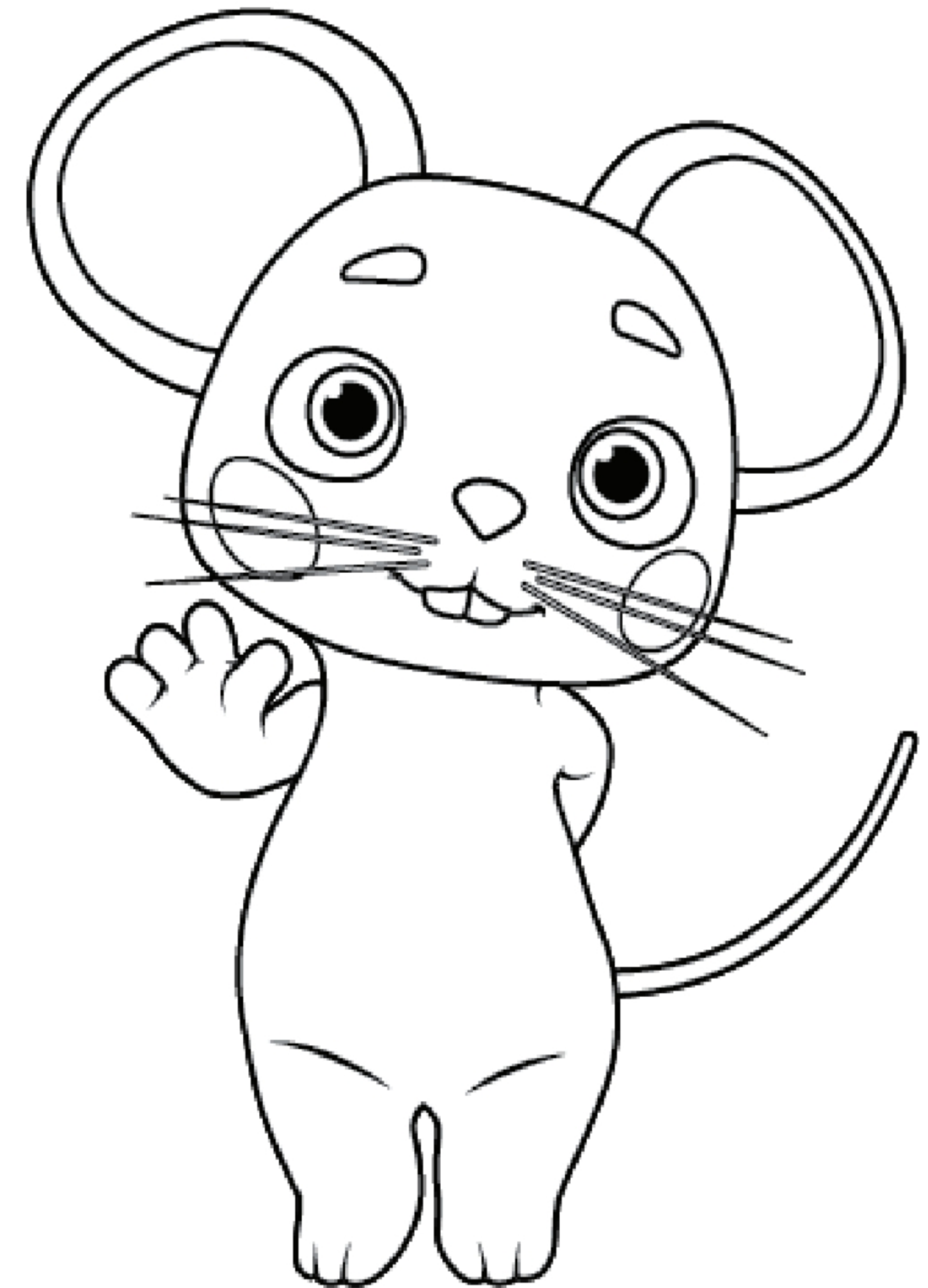

M MUSHROOM

M MOUSE



A Project of FIMS SCHOOLS
WORKSHEET POINT
www.worksheetpoint.com

Name: _____

Date: _____

Grade: _____

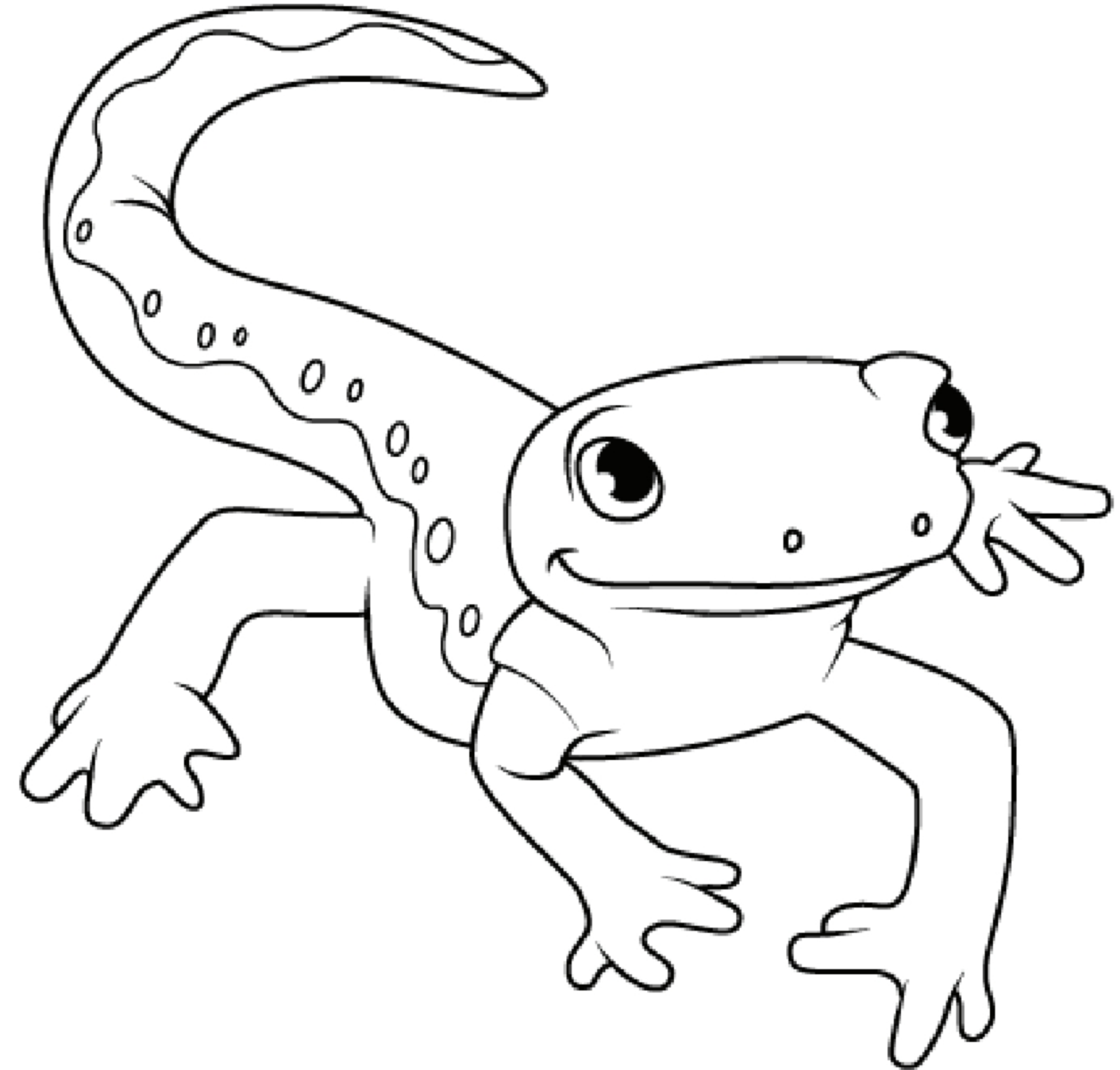
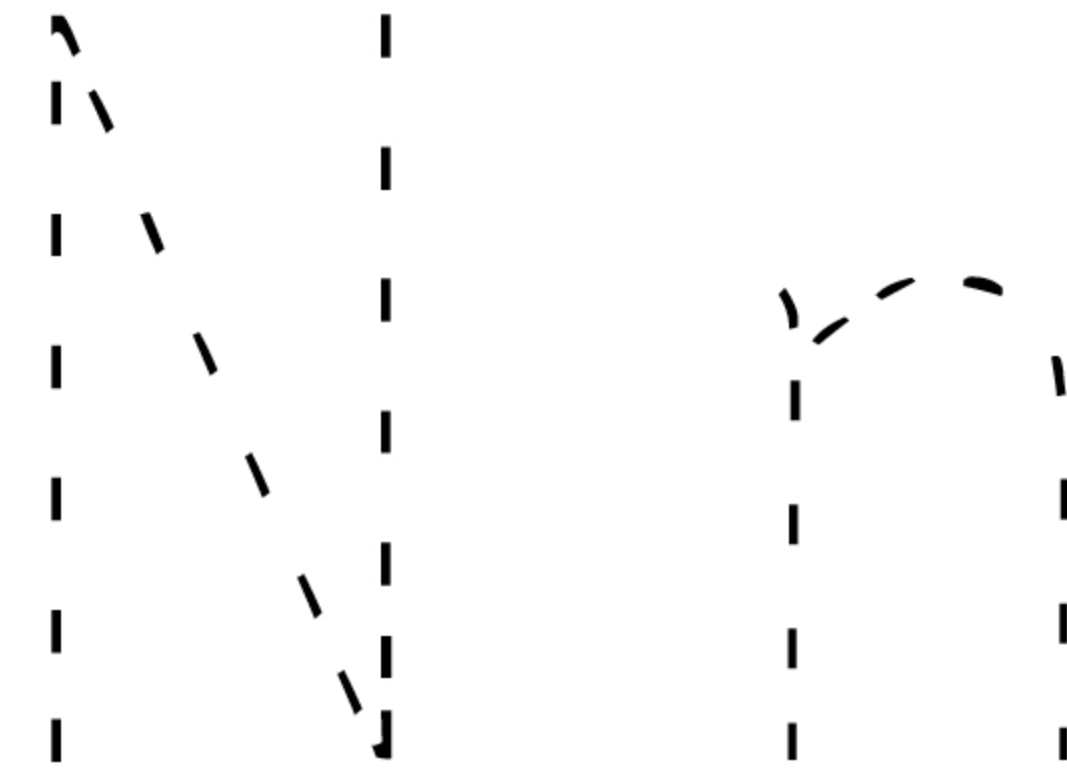

NEST

NEWT



A Project of FIMS SCHOOLS
WORKSHEET POINT
www.worksheetpoint.com

Name: _____

Date: _____

Grade: _____

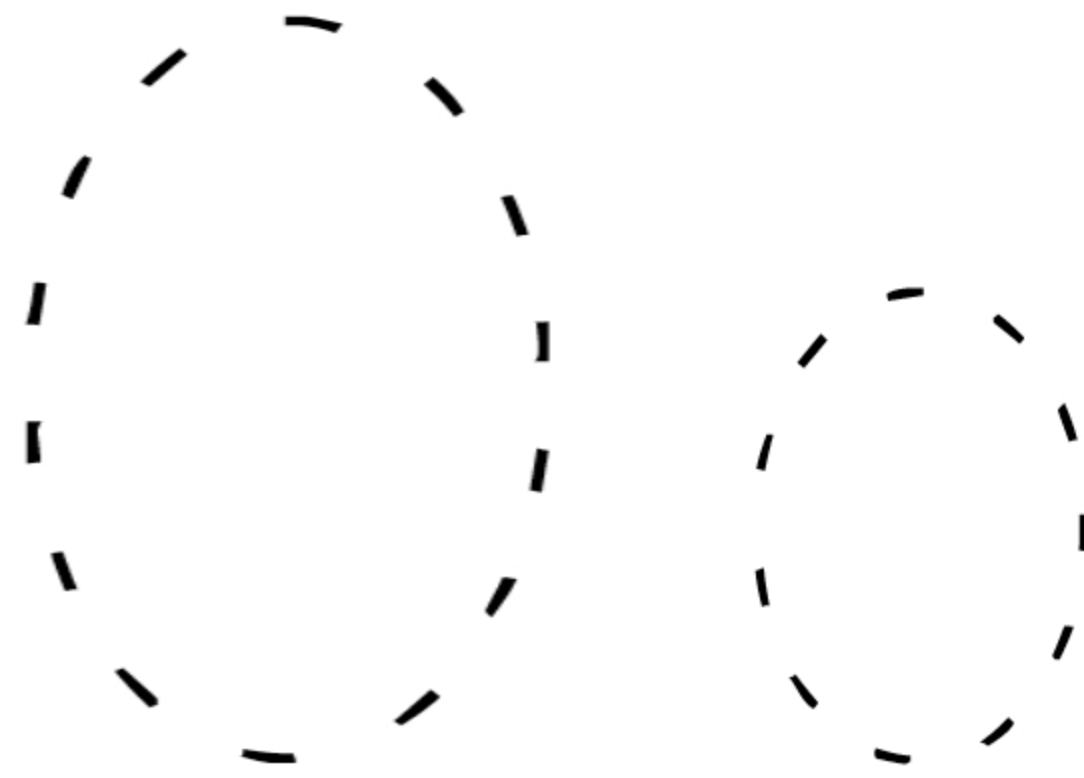
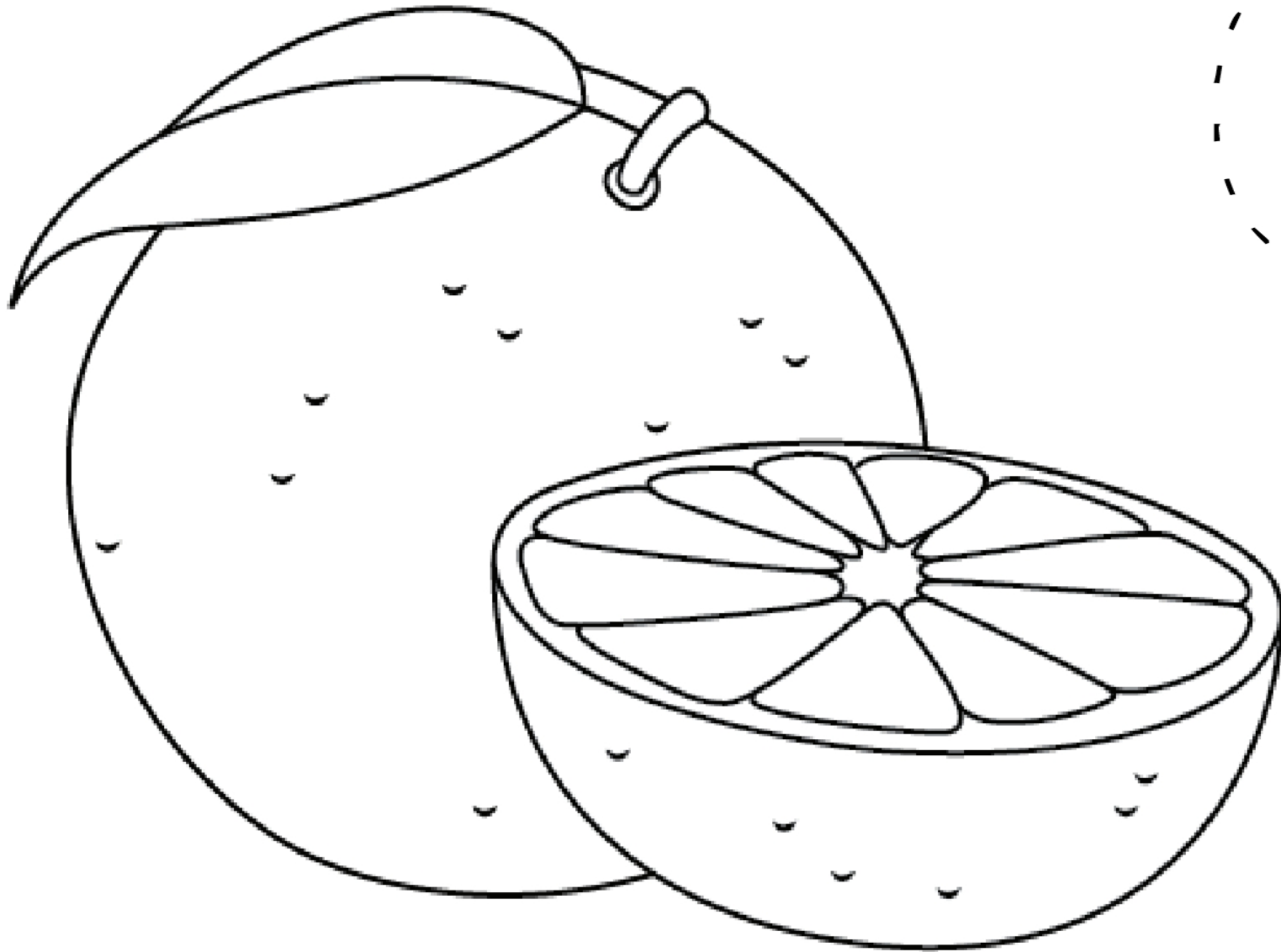

○ R A N G E

○ O W L



A Project of FIMS SCHOOLS
WORKSHEET POINT
www.worksheetpoint.com

Name: _____

Date: _____

Grade: _____

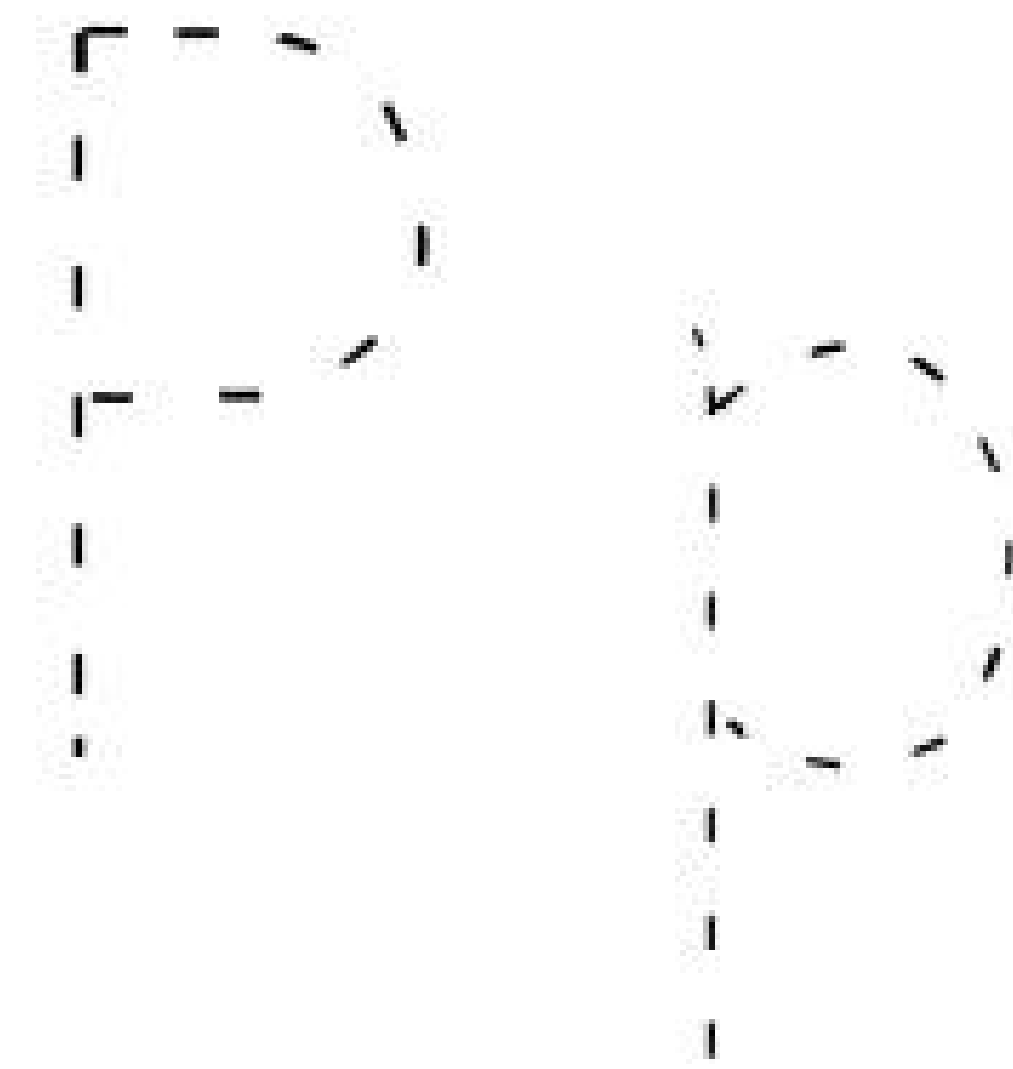
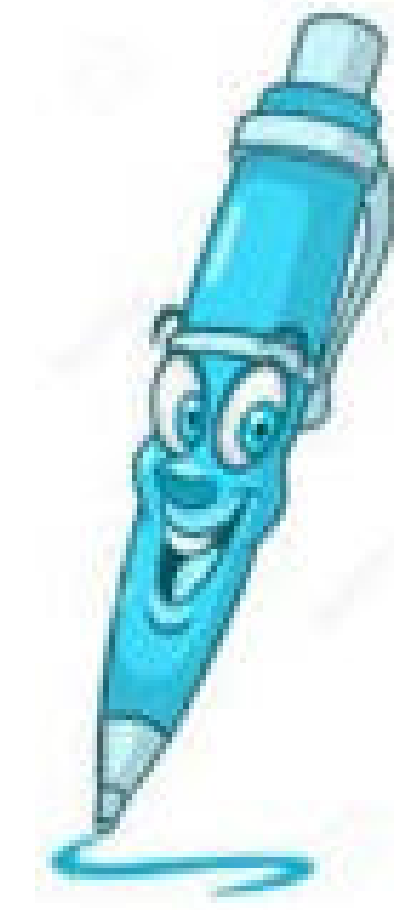

PUMPKIN

PARROT



A Project of FIMS SCHOOLS
WORKSHEET POINT
www.worksheetpoint.com

Name: _____

Date: _____

Grade: _____

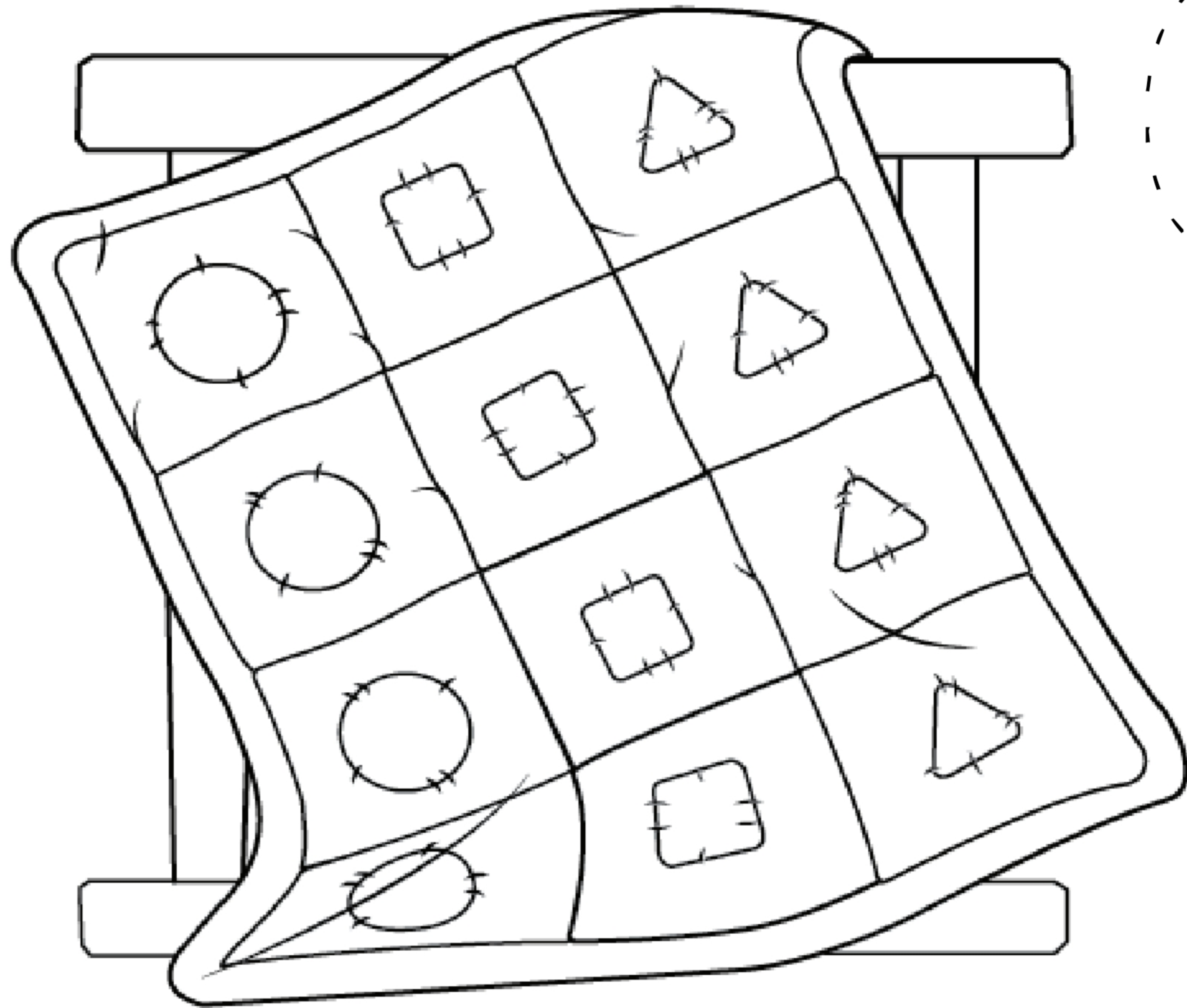

QUILT

QUEEN



A Project of FIMS SCHOOLS
WORKSHEET POINT
www.worksheetpoint.com

Name: _____

Date: _____

Grade: _____

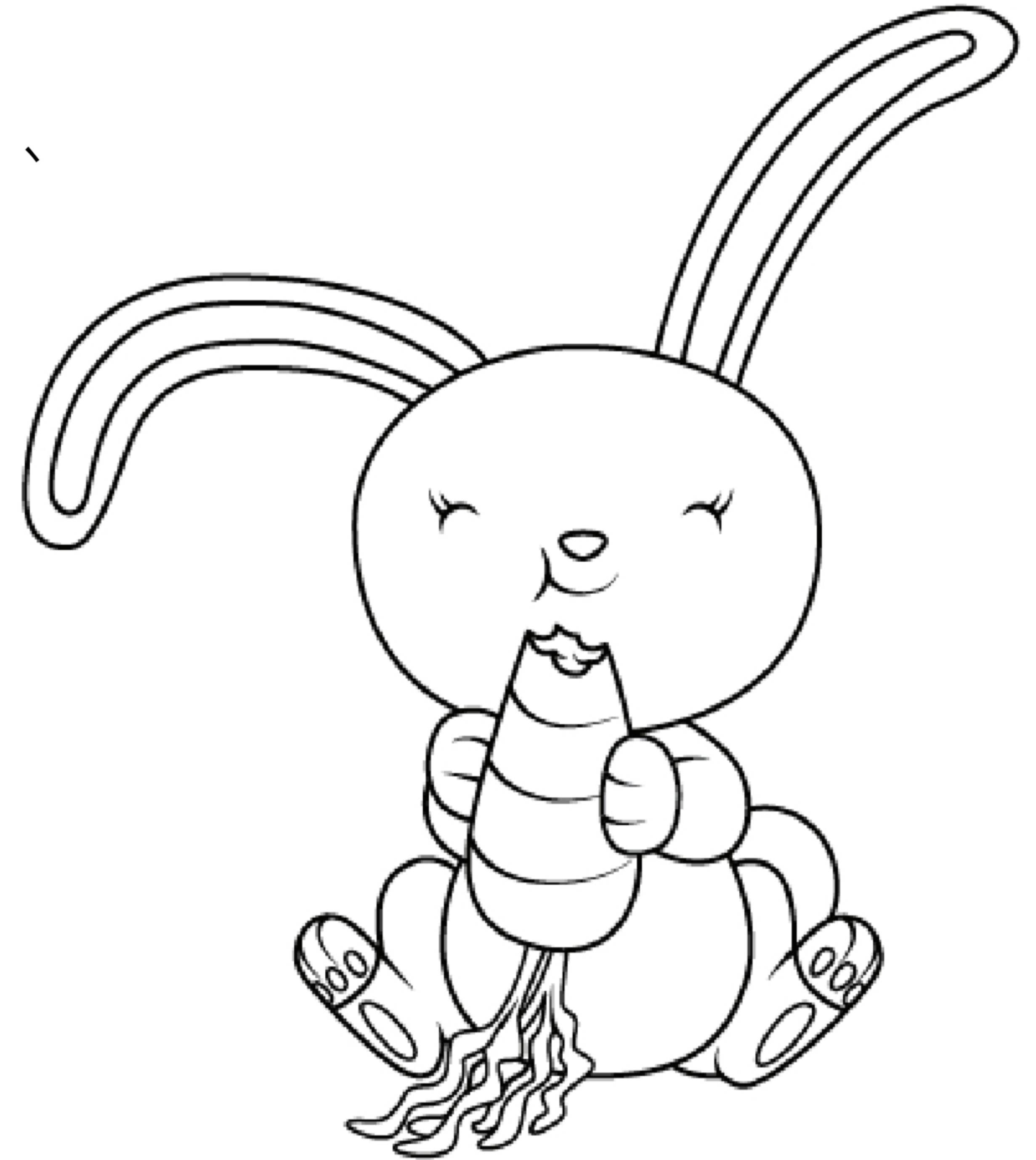
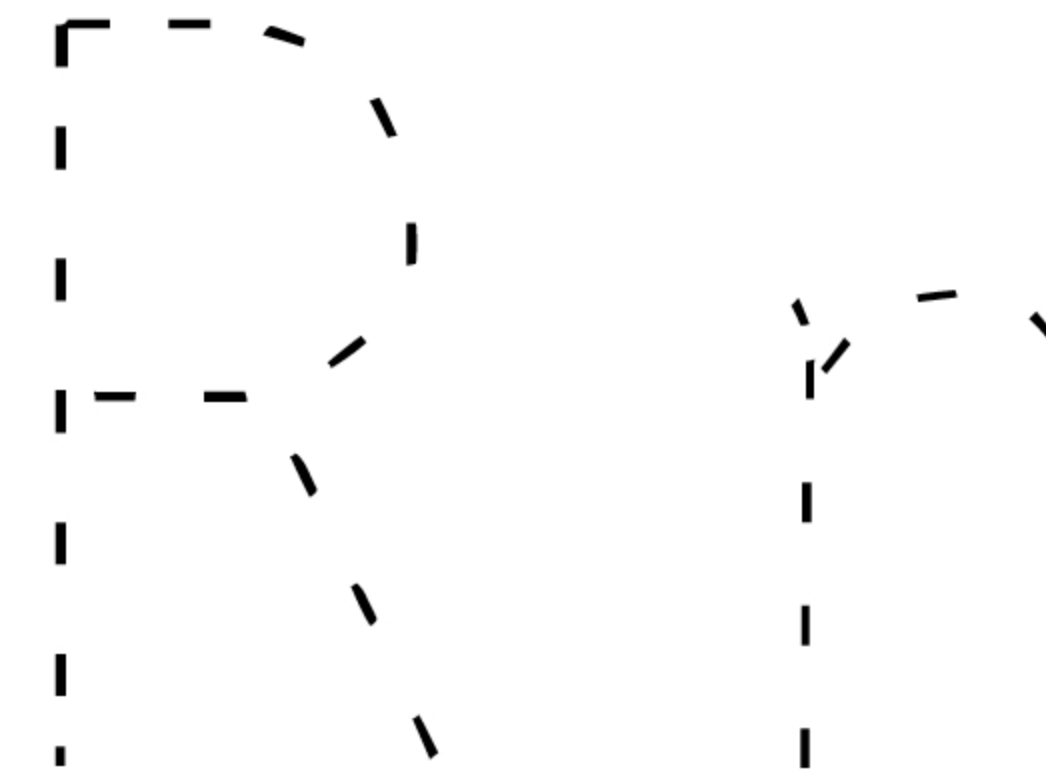
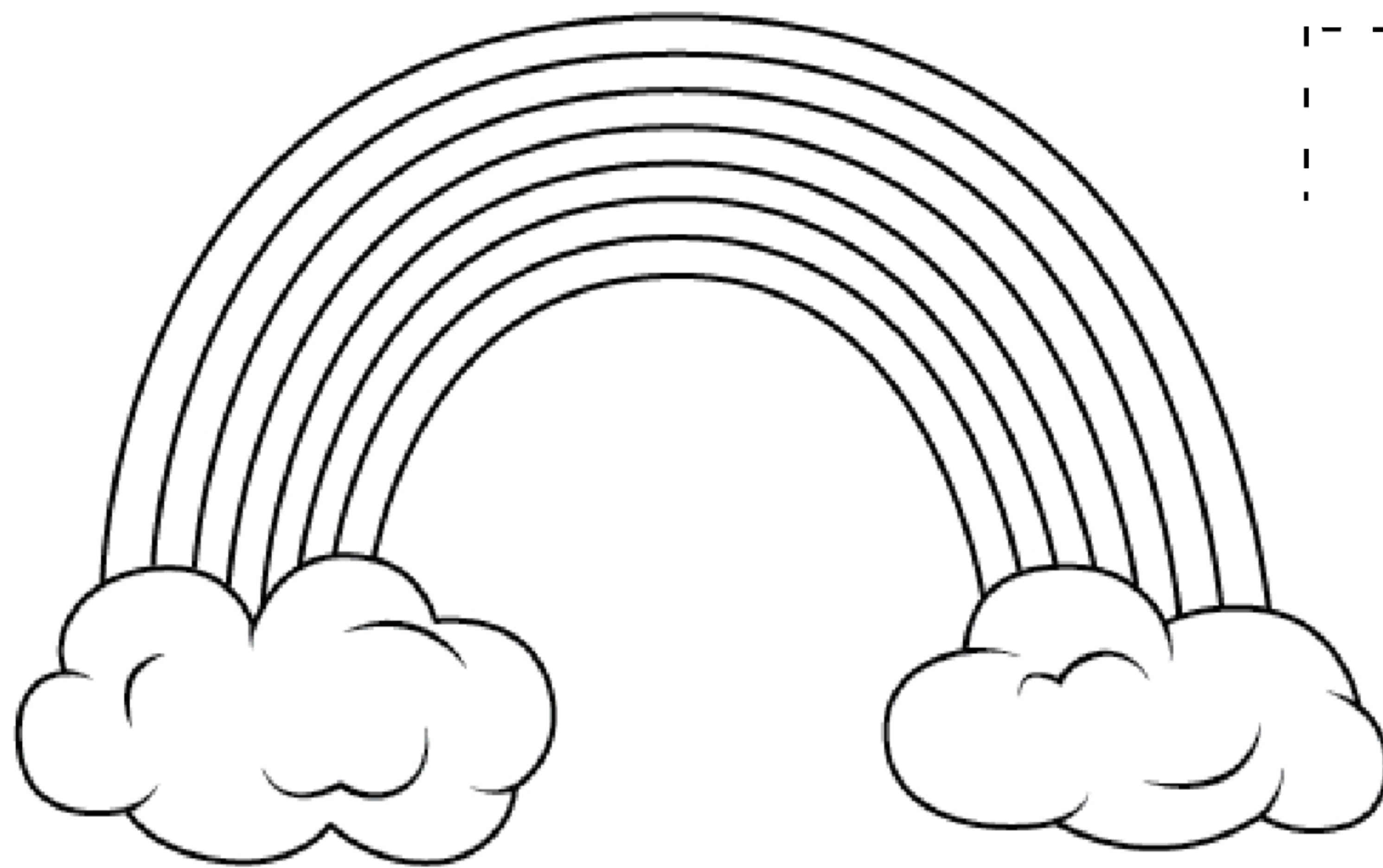

RAINBOW

RABBIT



A Project of FIMS SCHOOLS
WORKSHEET POINT
www.worksheetpoint.com

Name: _____

Date: _____

Grade: _____

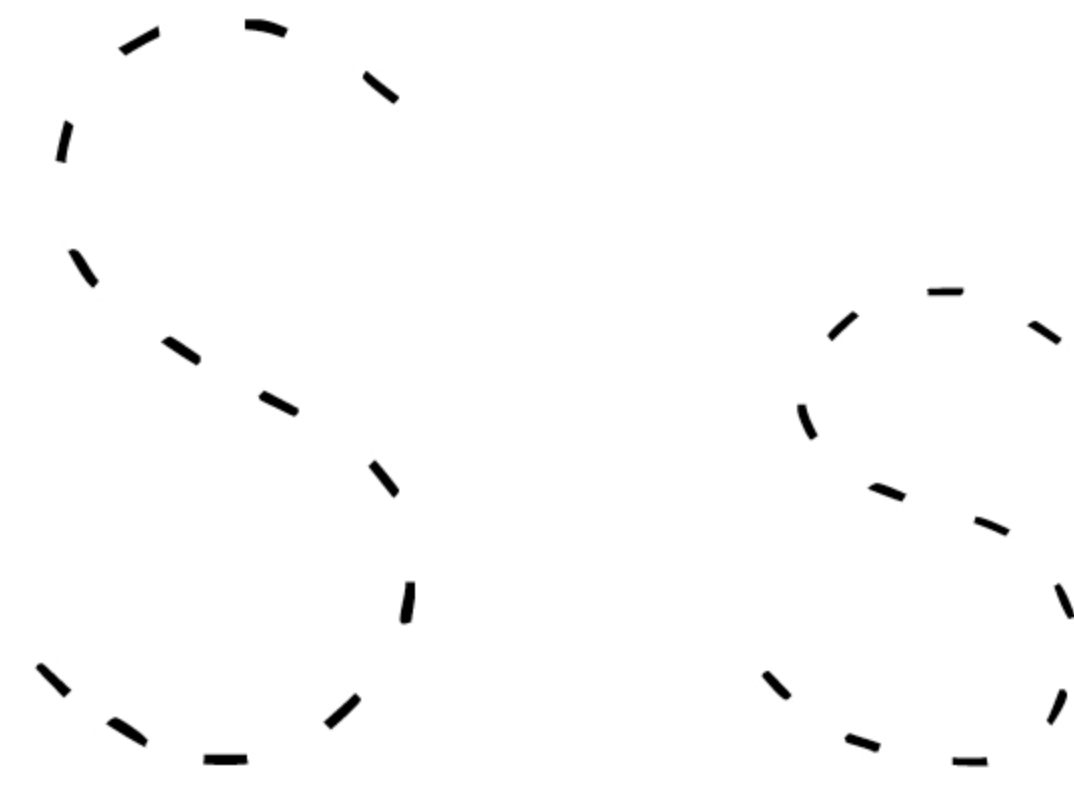
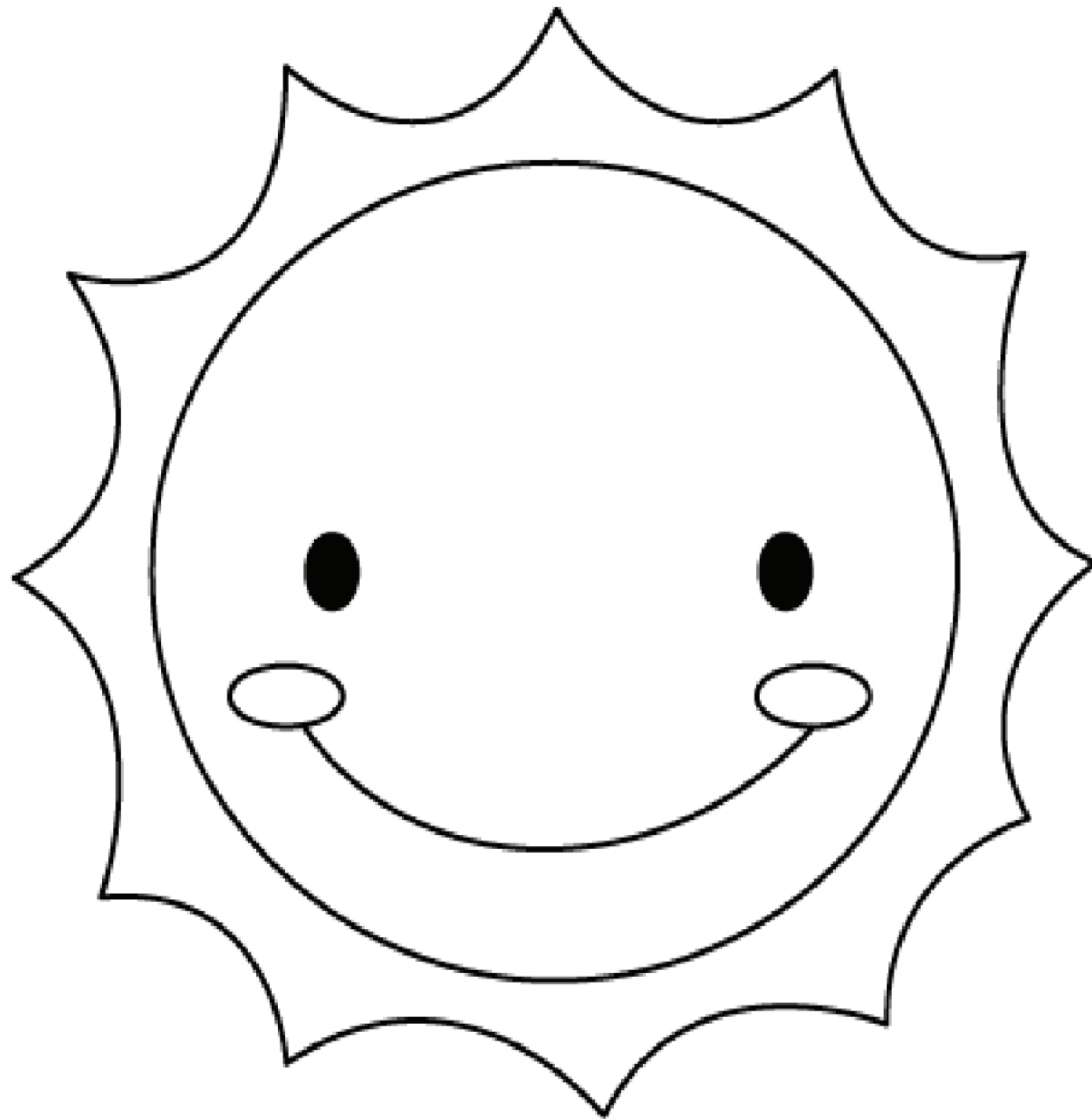

SUN

SQUIRREL



A Project of FIMS SCHOOLS
WORKSHEET POINT
www.worksheetpoint.com

Name: _____

Date: _____

Grade: _____

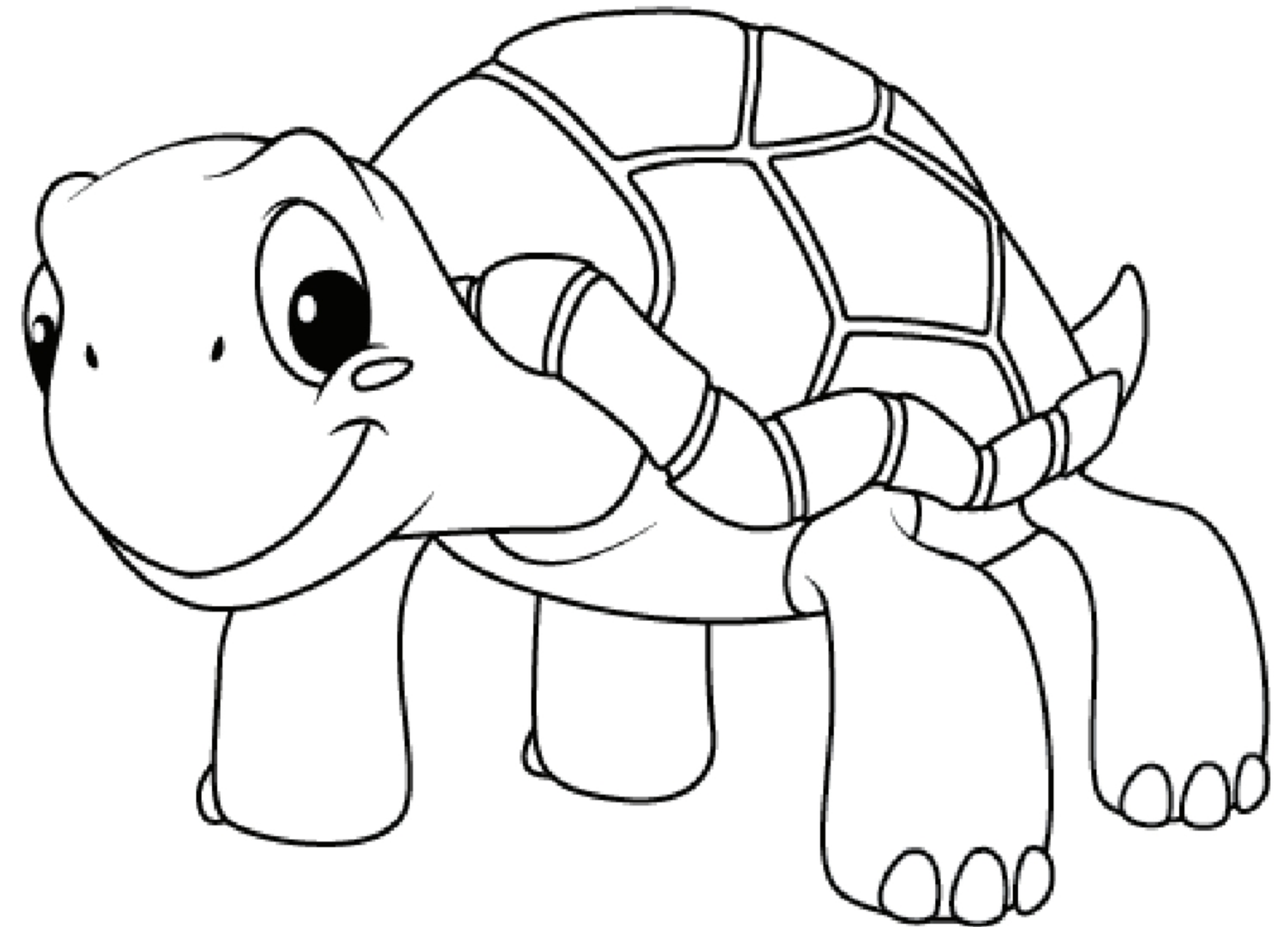
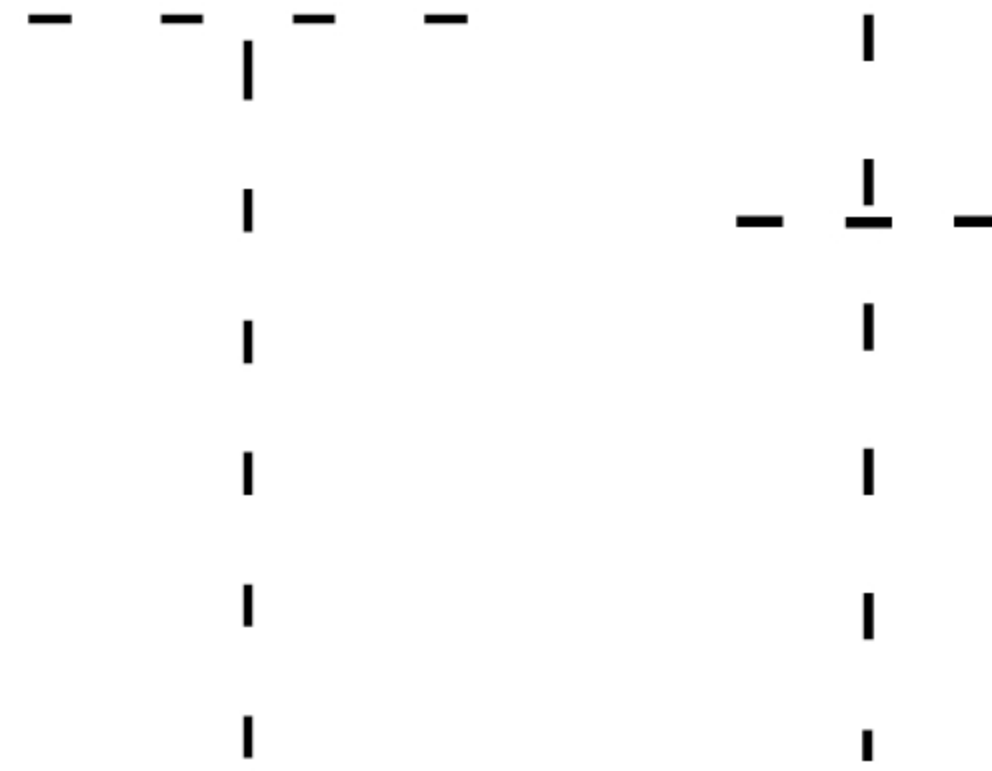
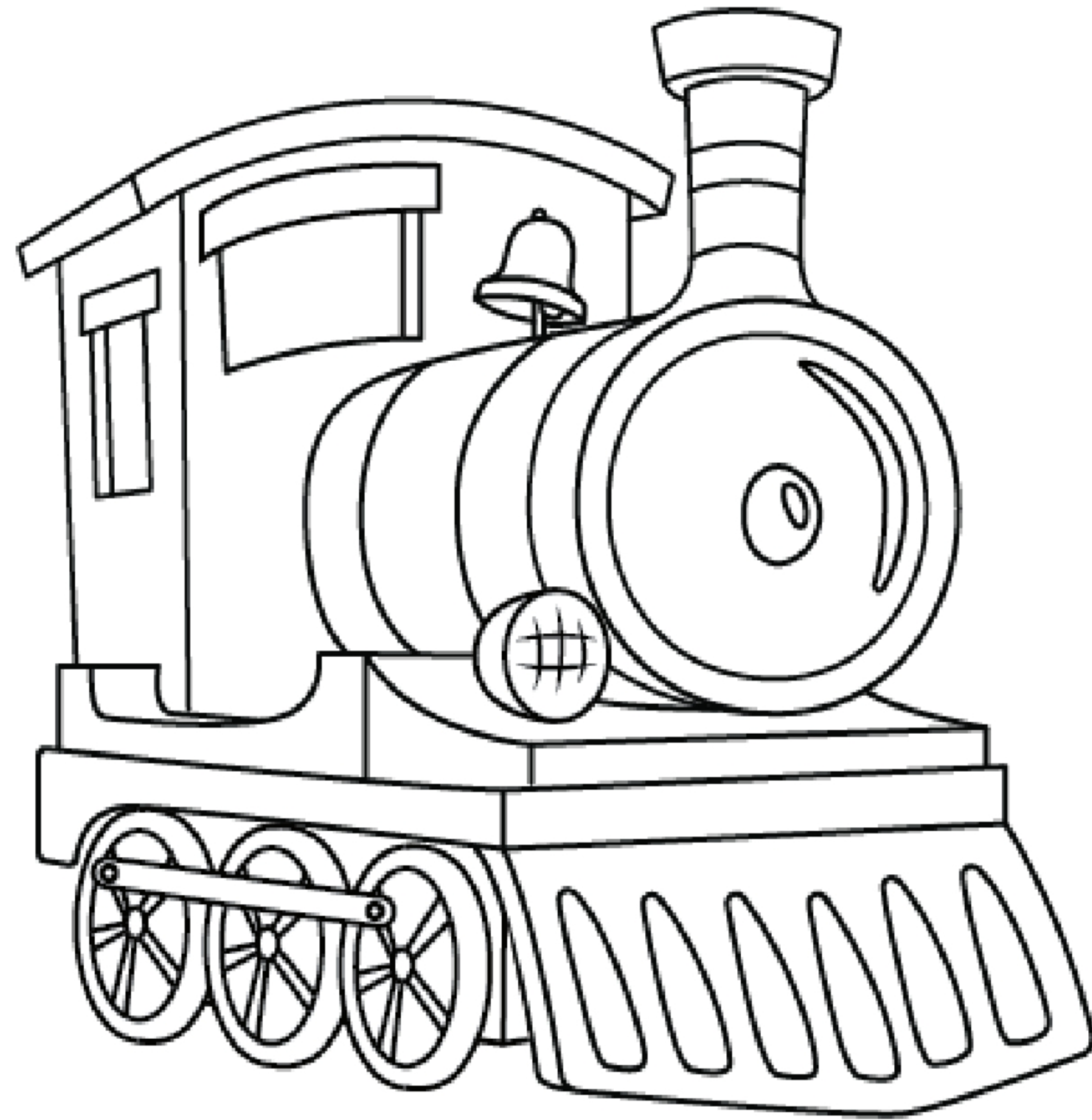

T RAIN

T URTLE



A Project of FIMS SCHOOLS
WORKSHEET POINT
www.worksheetpoint.com

Name: _____

Date: _____

Grade: _____

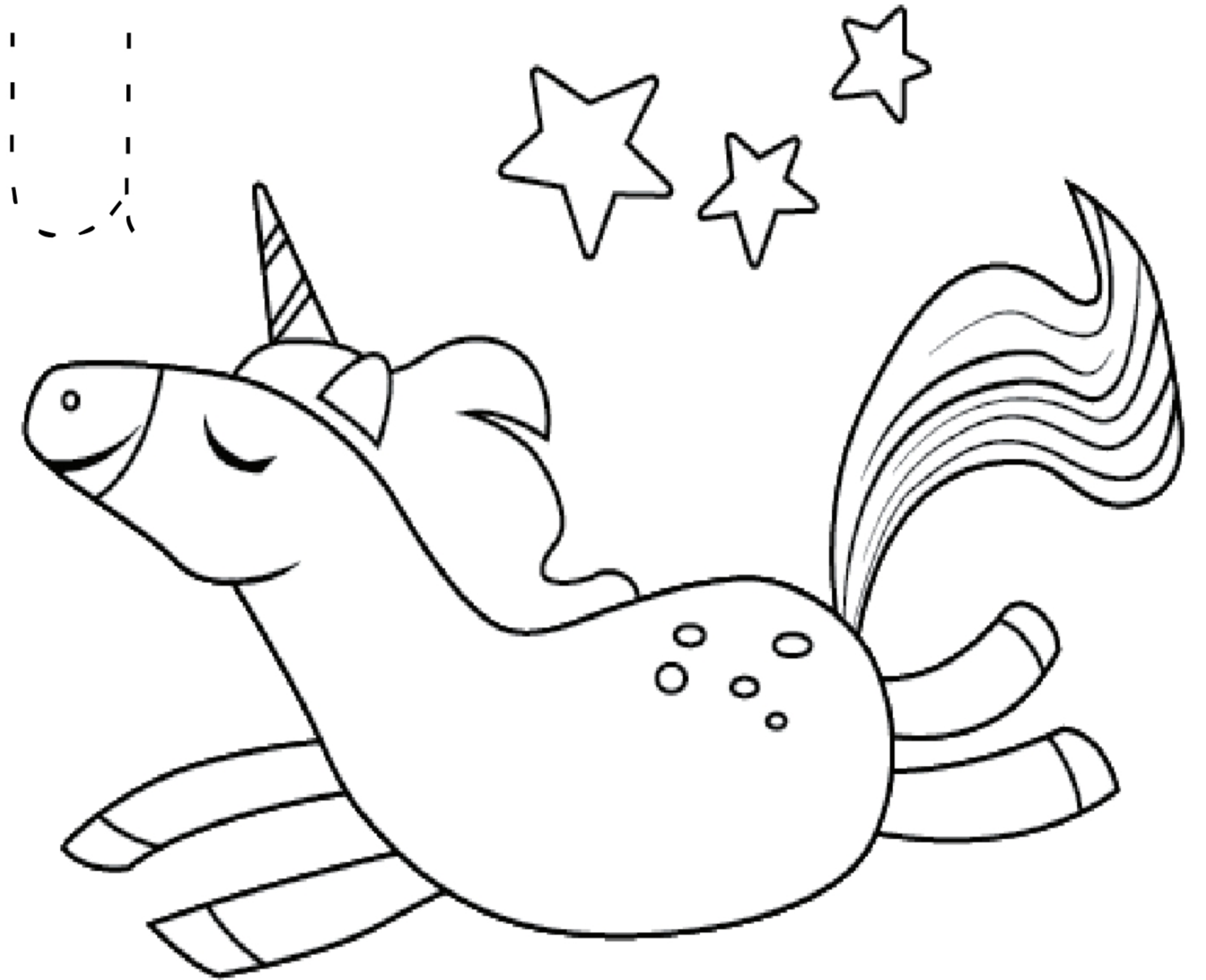
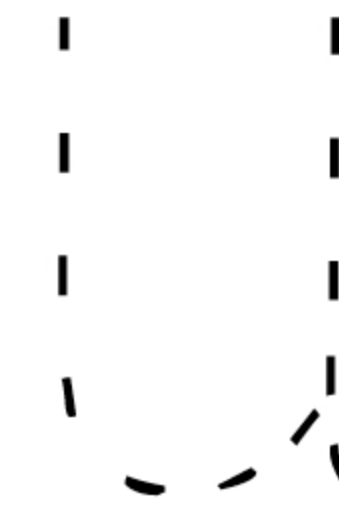
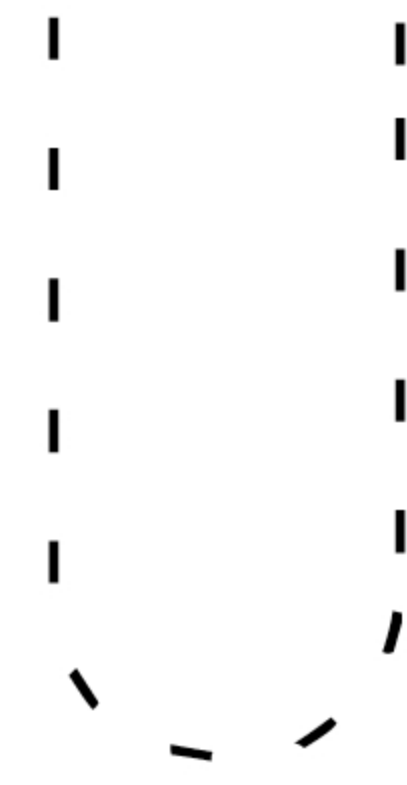
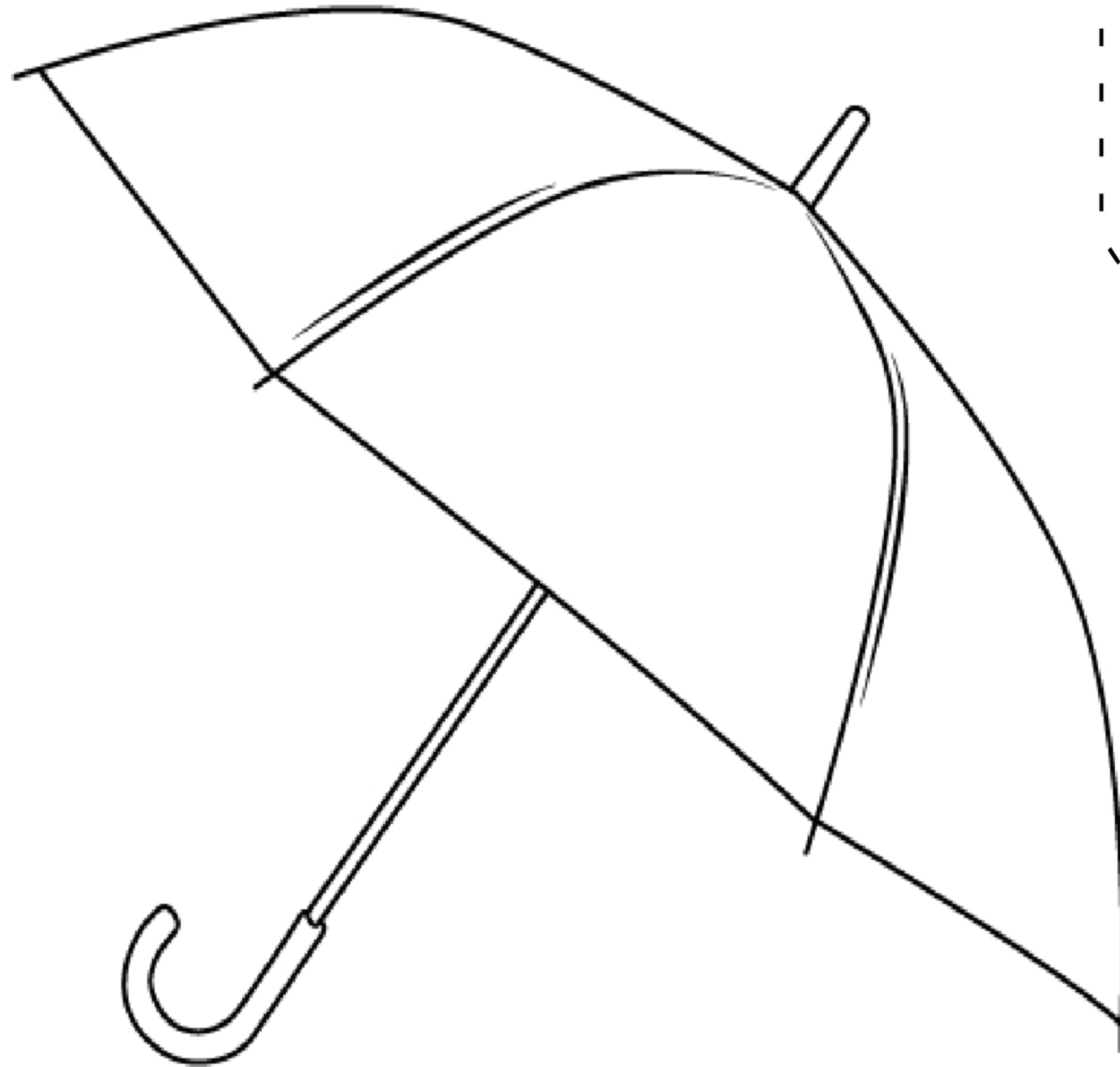

UMBRELLA

UNICORN



A Project of FIMS SCHOOLS
WORKSHEET POINT
www.worksheetpoint.com

Name: _____

Date: _____

Grade: _____



V I O L I N

V U L T U R E



A Project of FIMS SCHOOLS
WORKSHEET POINT
www.worksheetpoint.com

Name: _____

Date: _____

Grade: _____

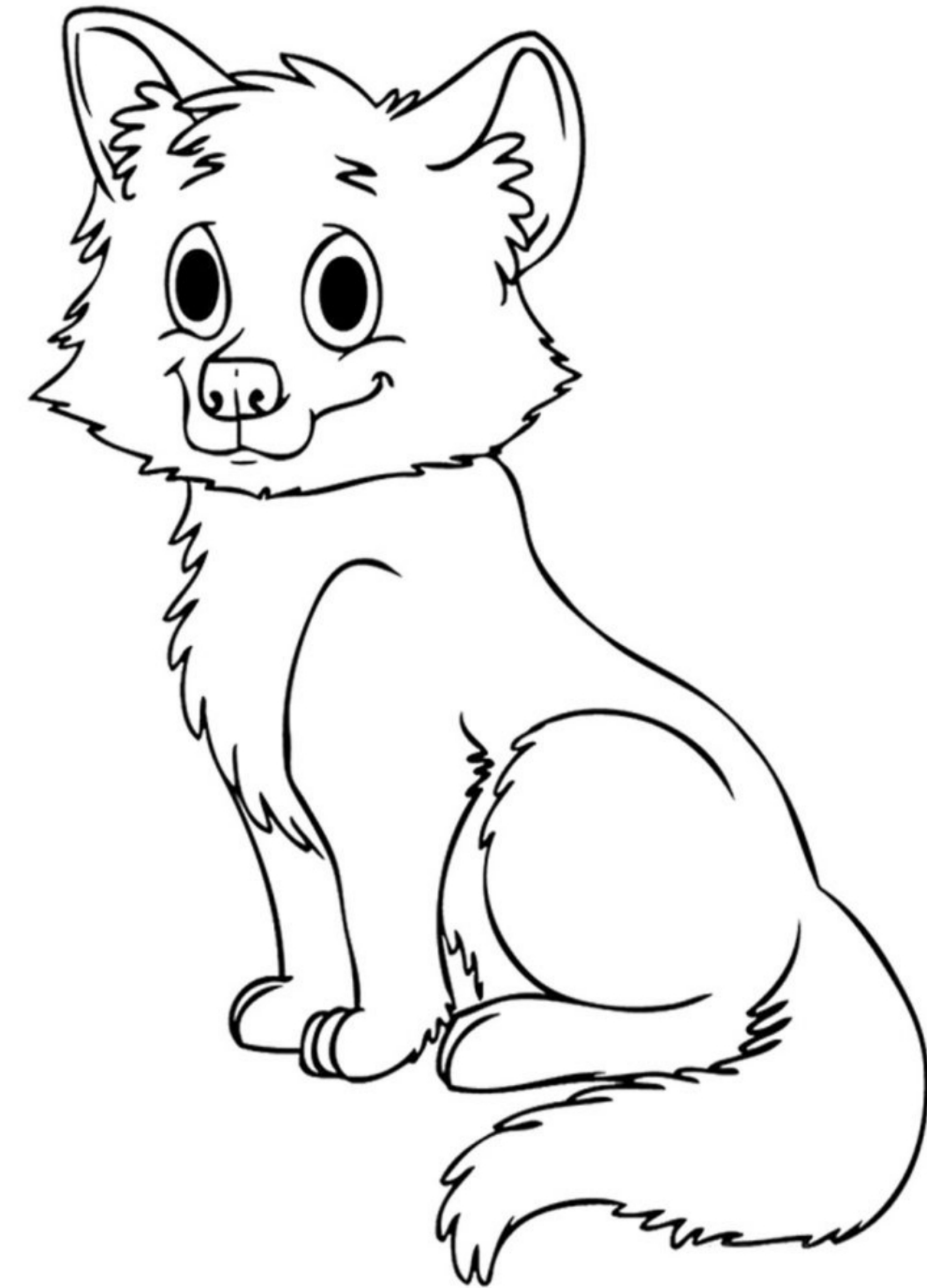
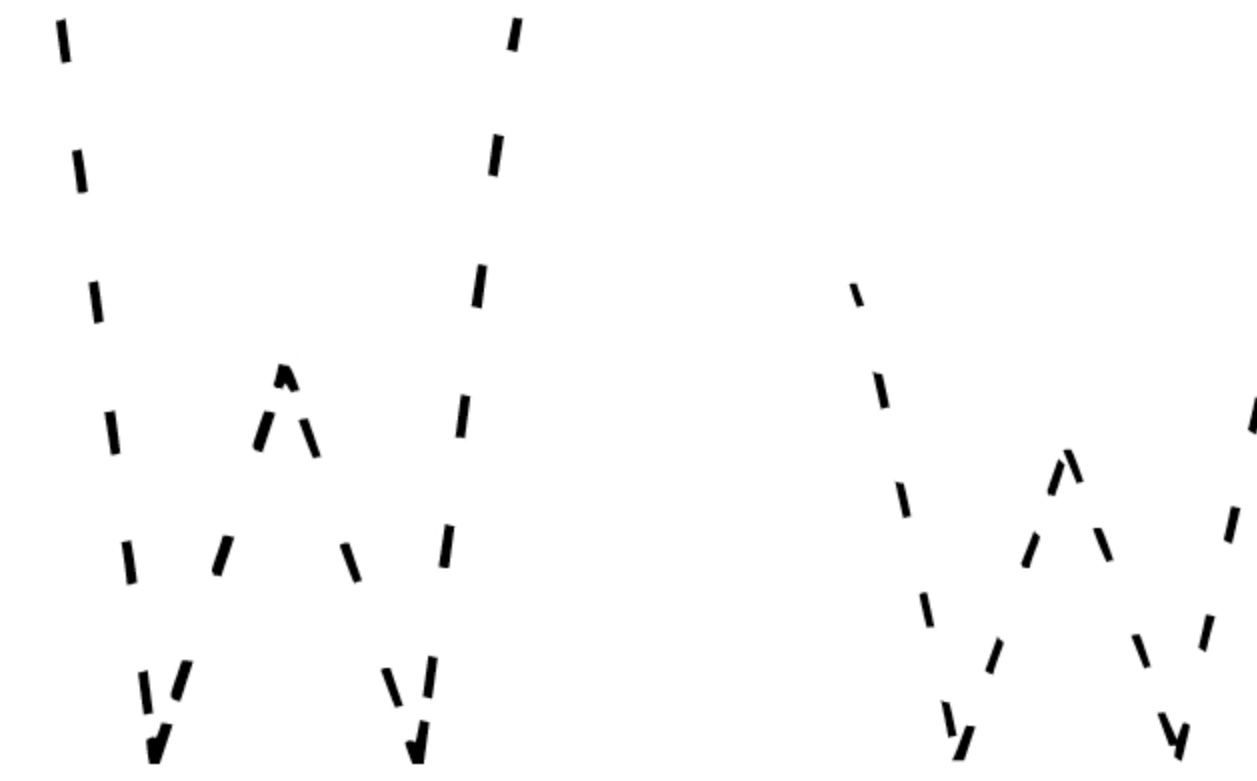
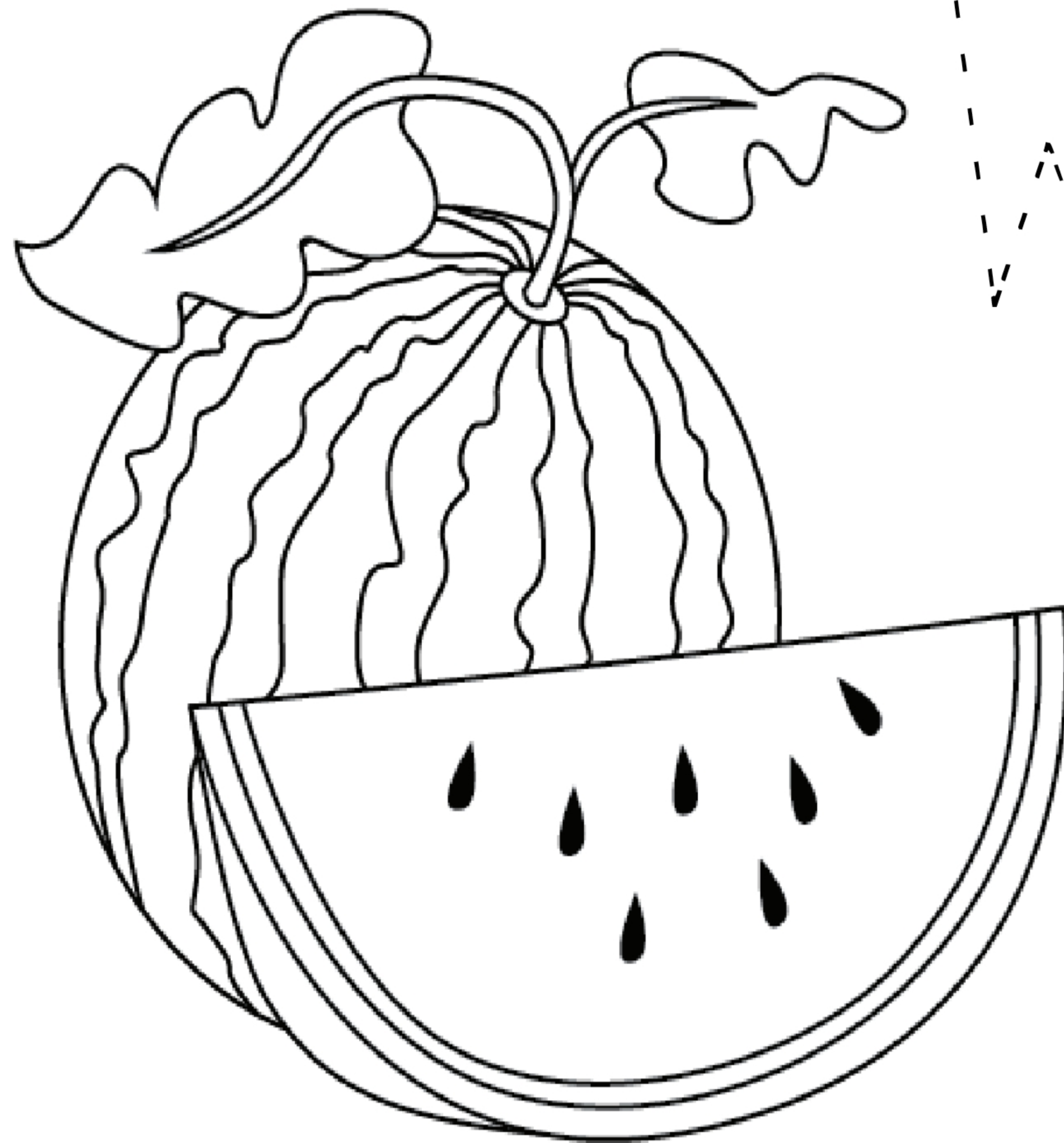

WATERMELON

WOLF



A Project of FIMS SCHOOLS
WORKSHEET POINT
www.worksheetpoint.com

Name: _____

Date: _____

Grade: _____

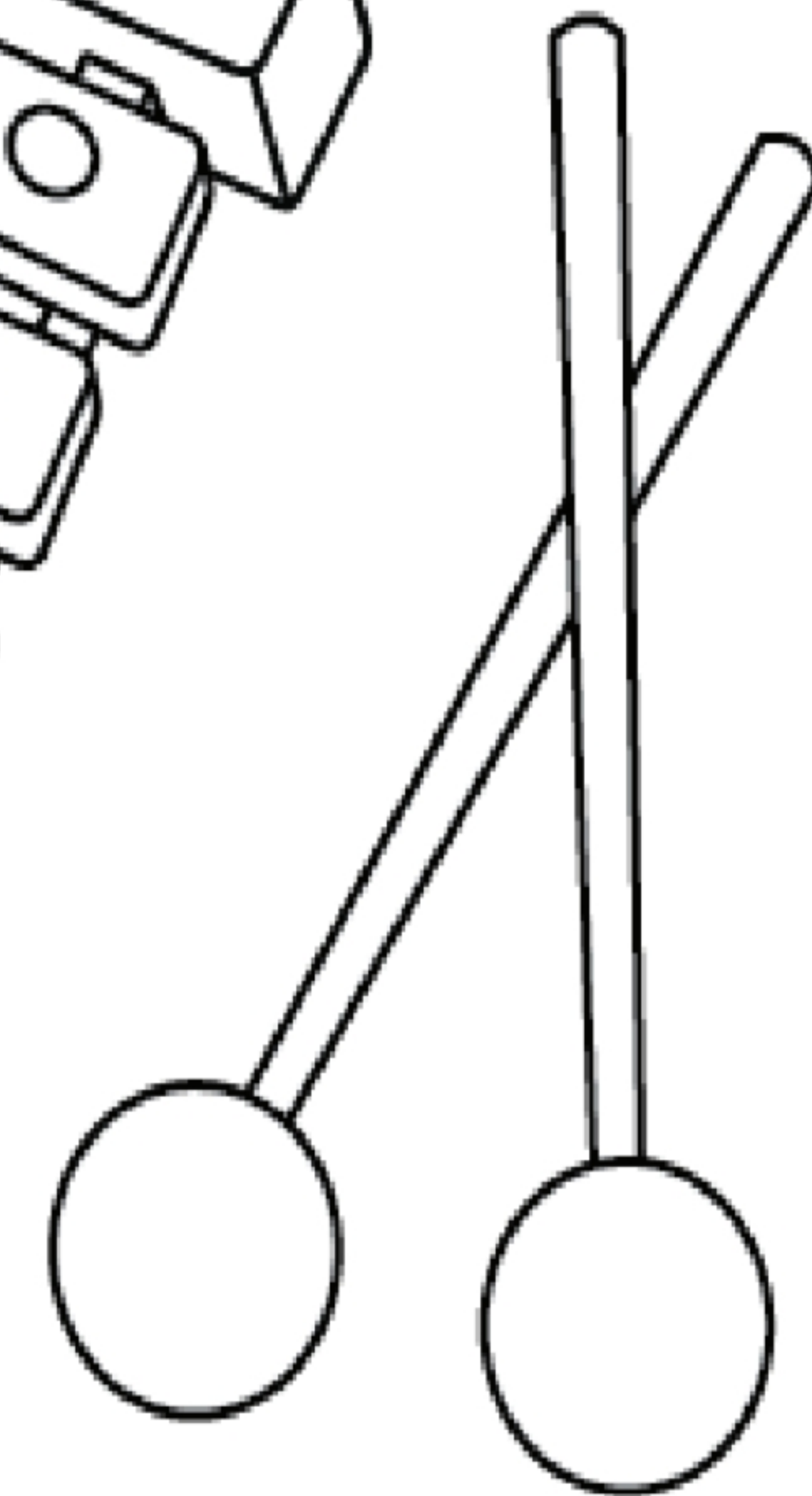
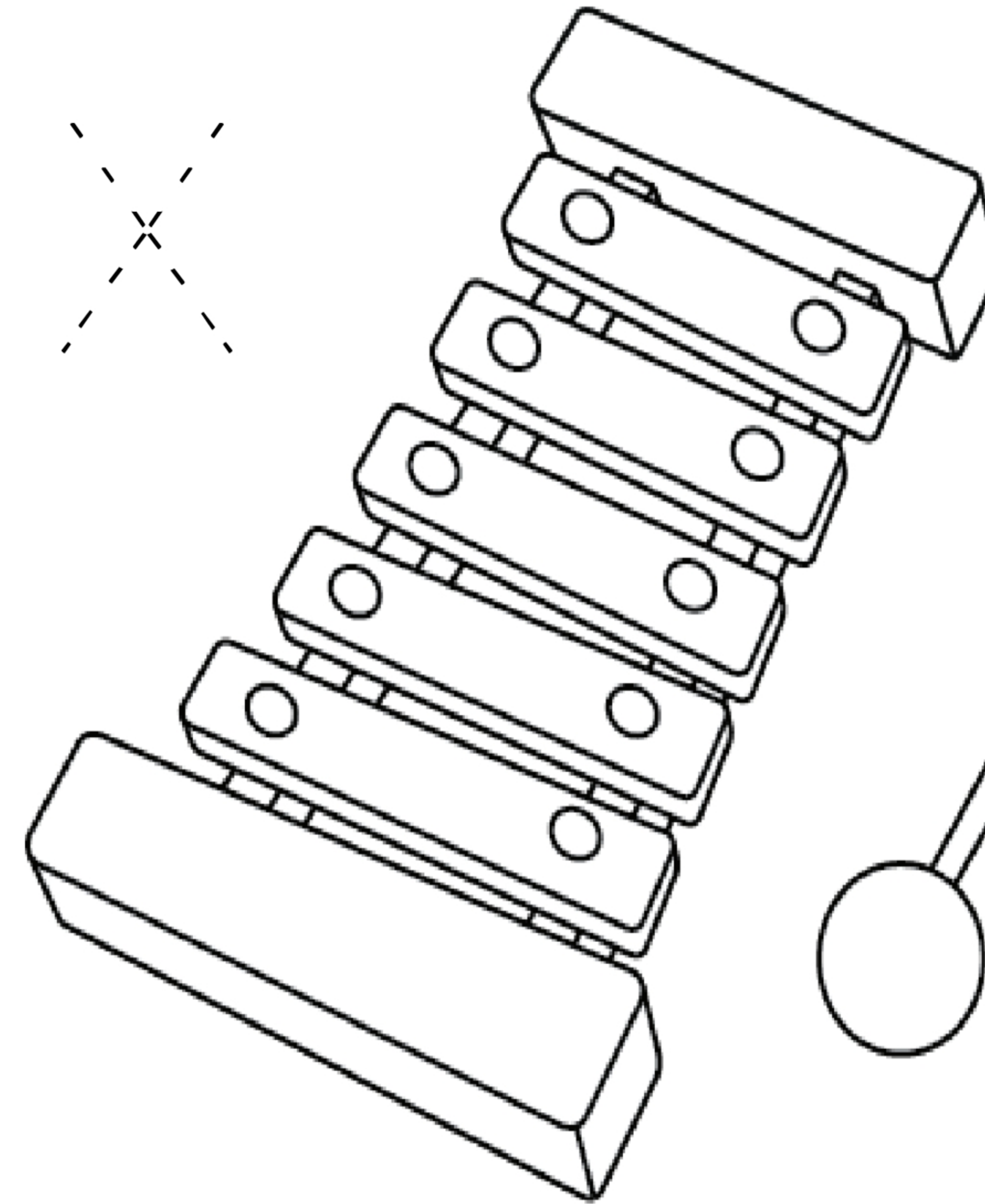
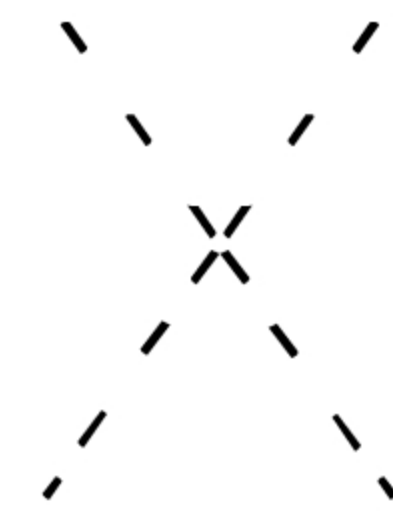
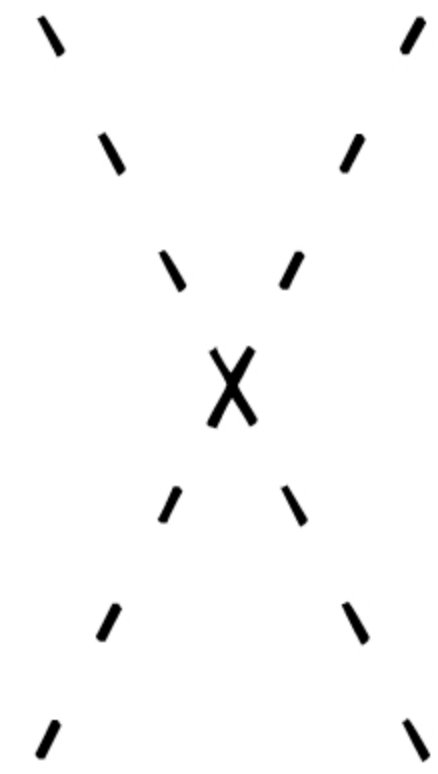
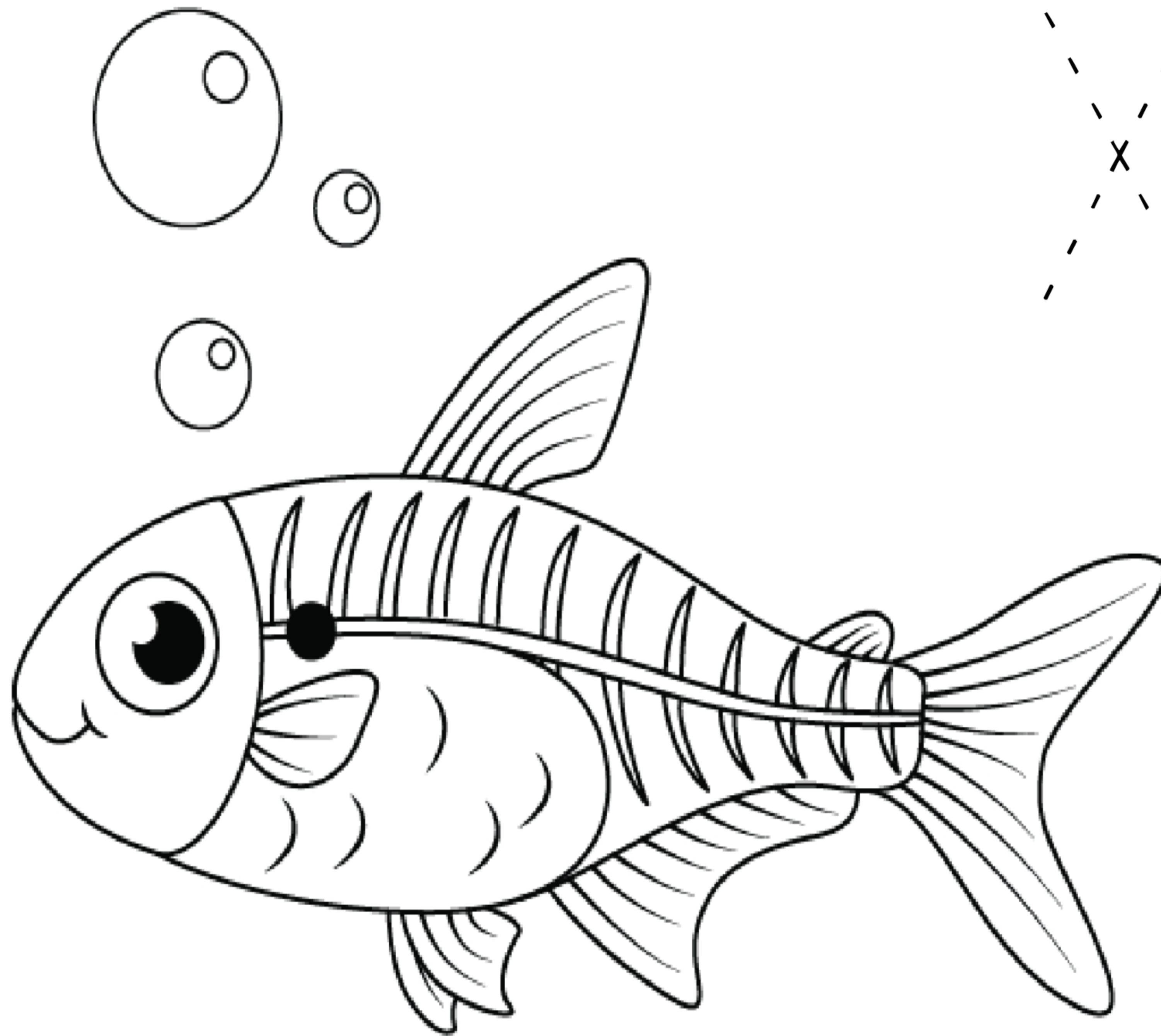

X-RAY FISH

X YLOPHONE



A Project of FIMS SCHOOLS
WORKSHEET POINT
www.worksheetpoint.com

Name: _____

Date: _____

Grade: _____

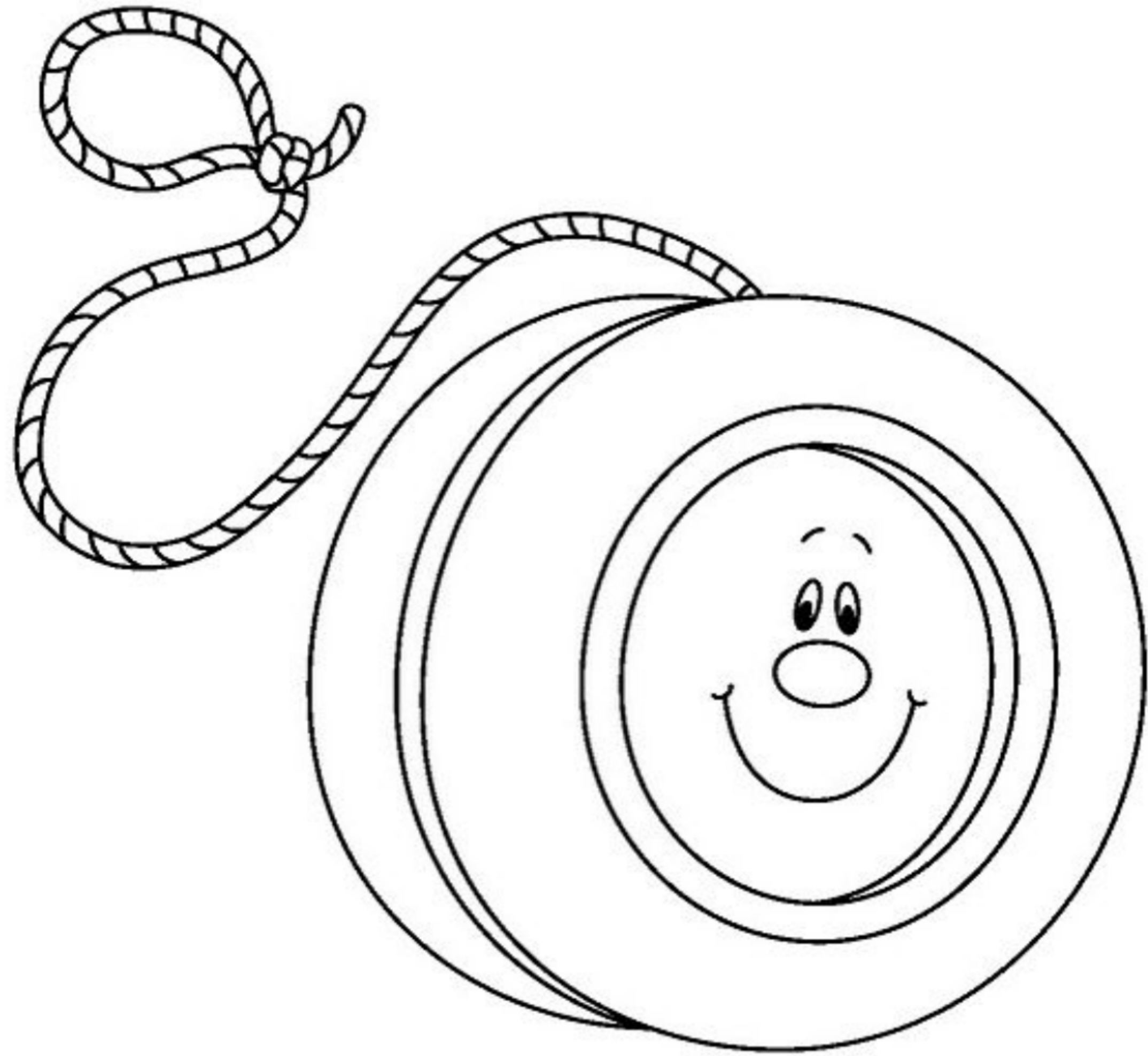
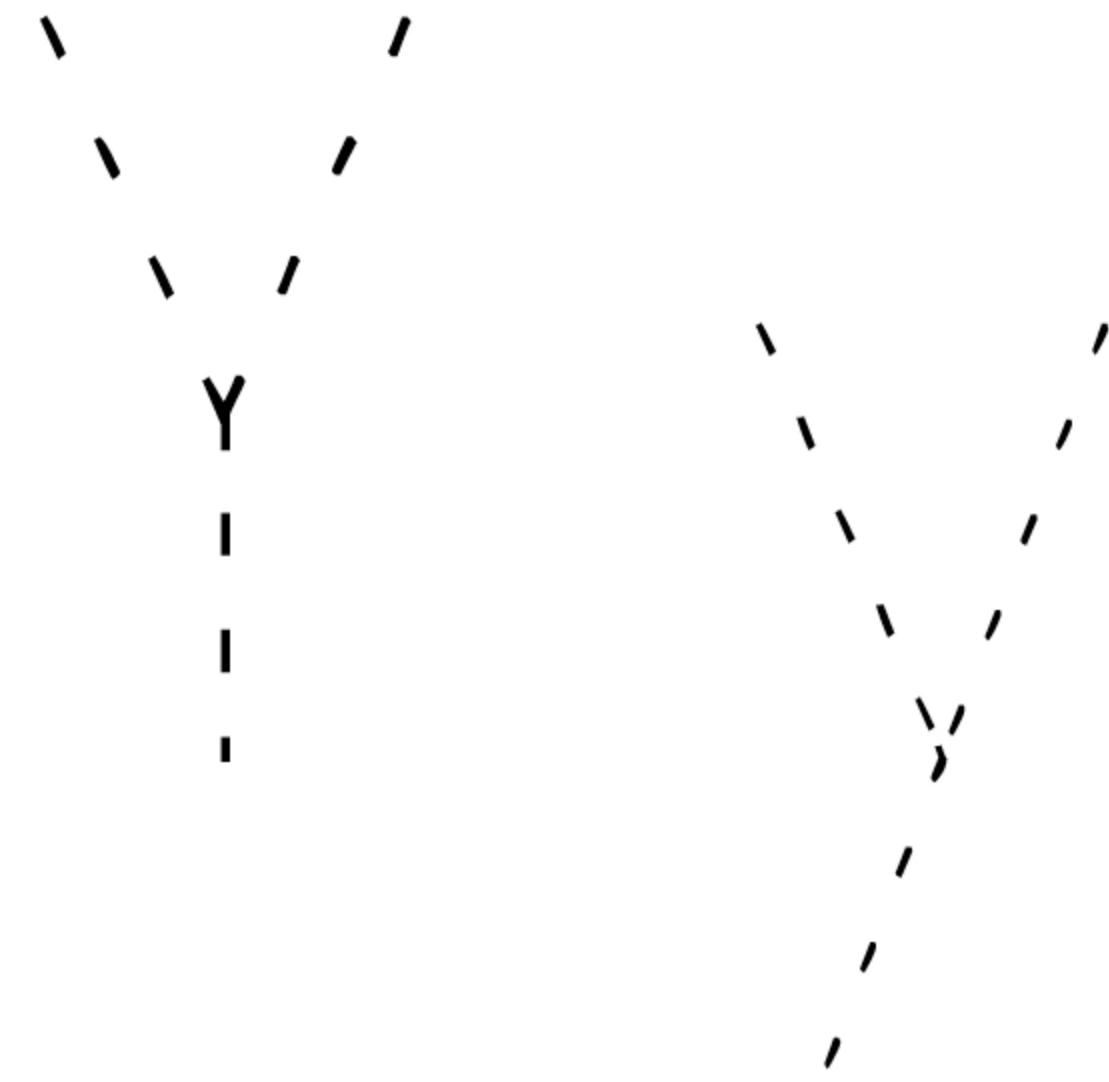

YOYO

YAK



A Project of FIMS SCHOOLS
WORKSHEET POINT
www.worksheetpoint.com

Name: _____

Date: _____

Grade: _____

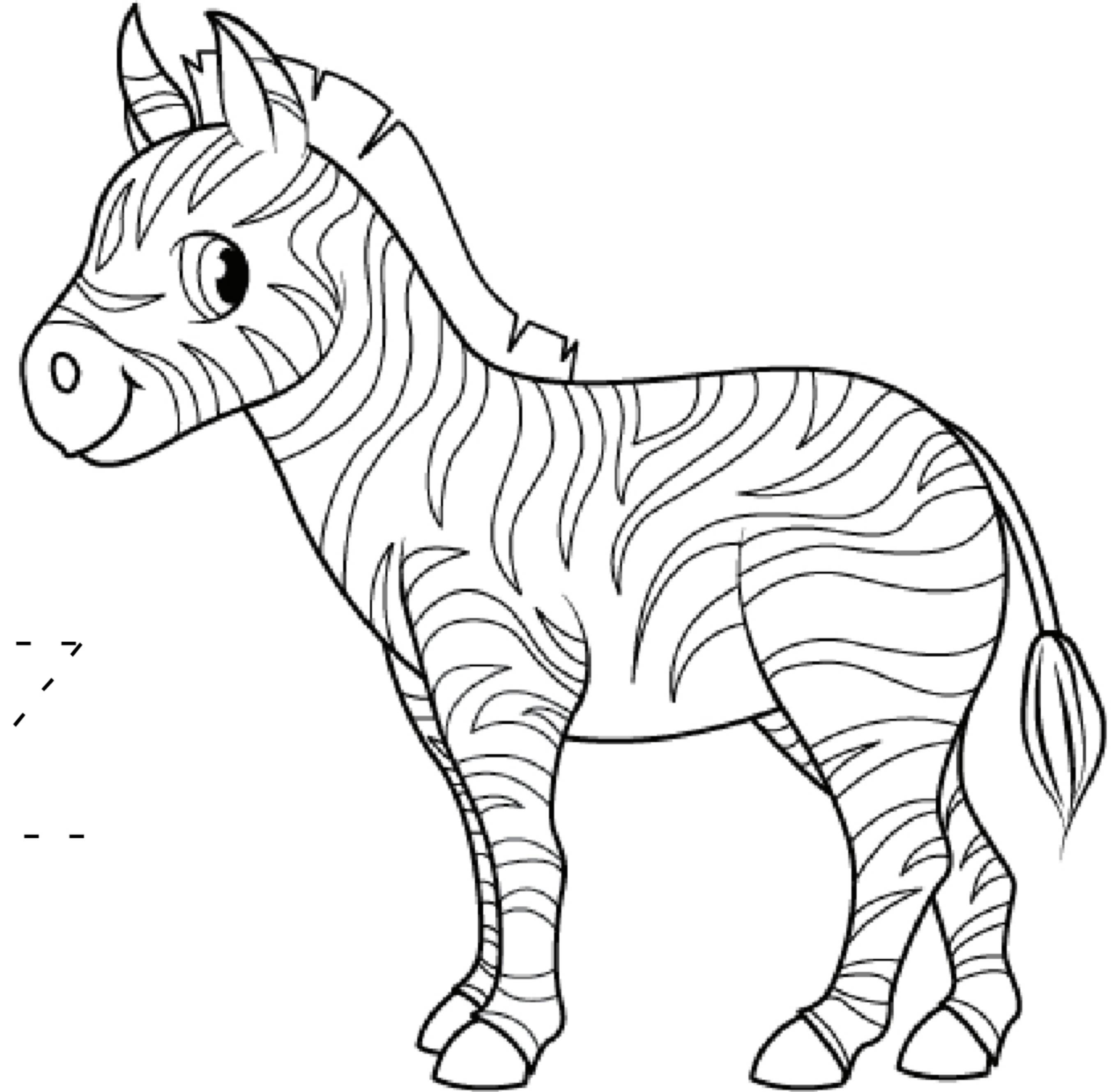
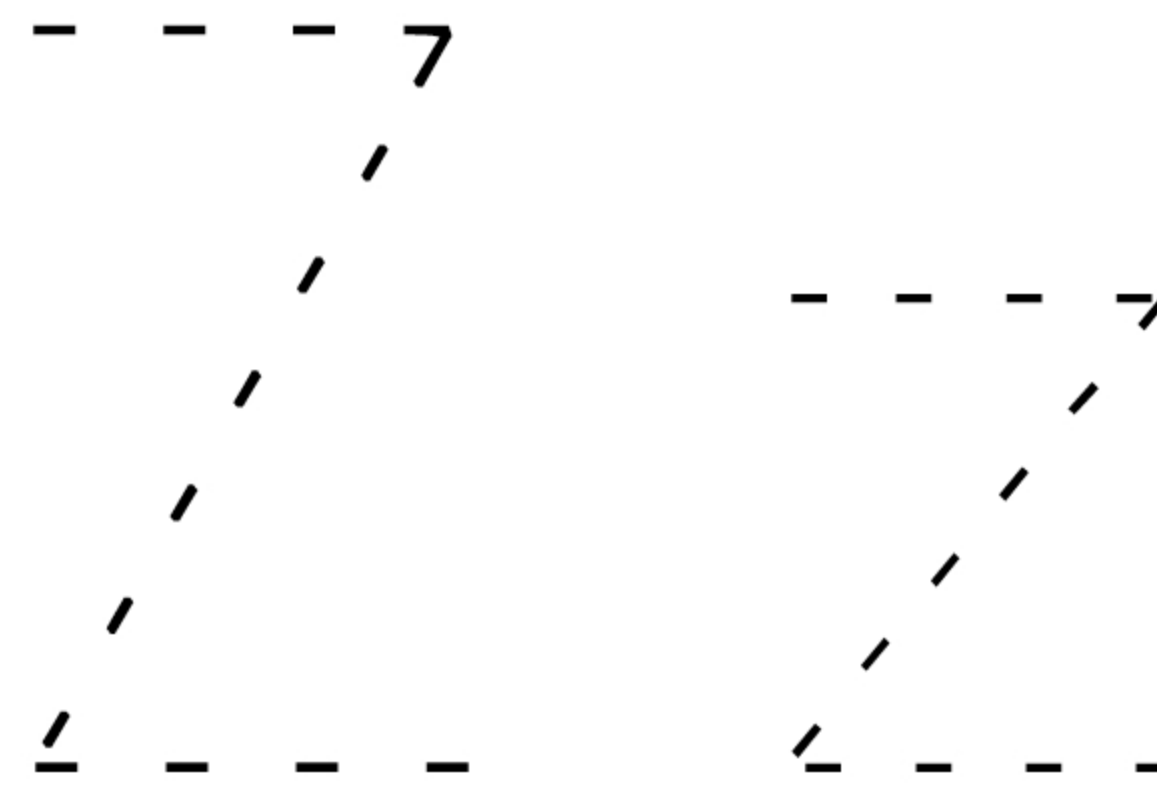
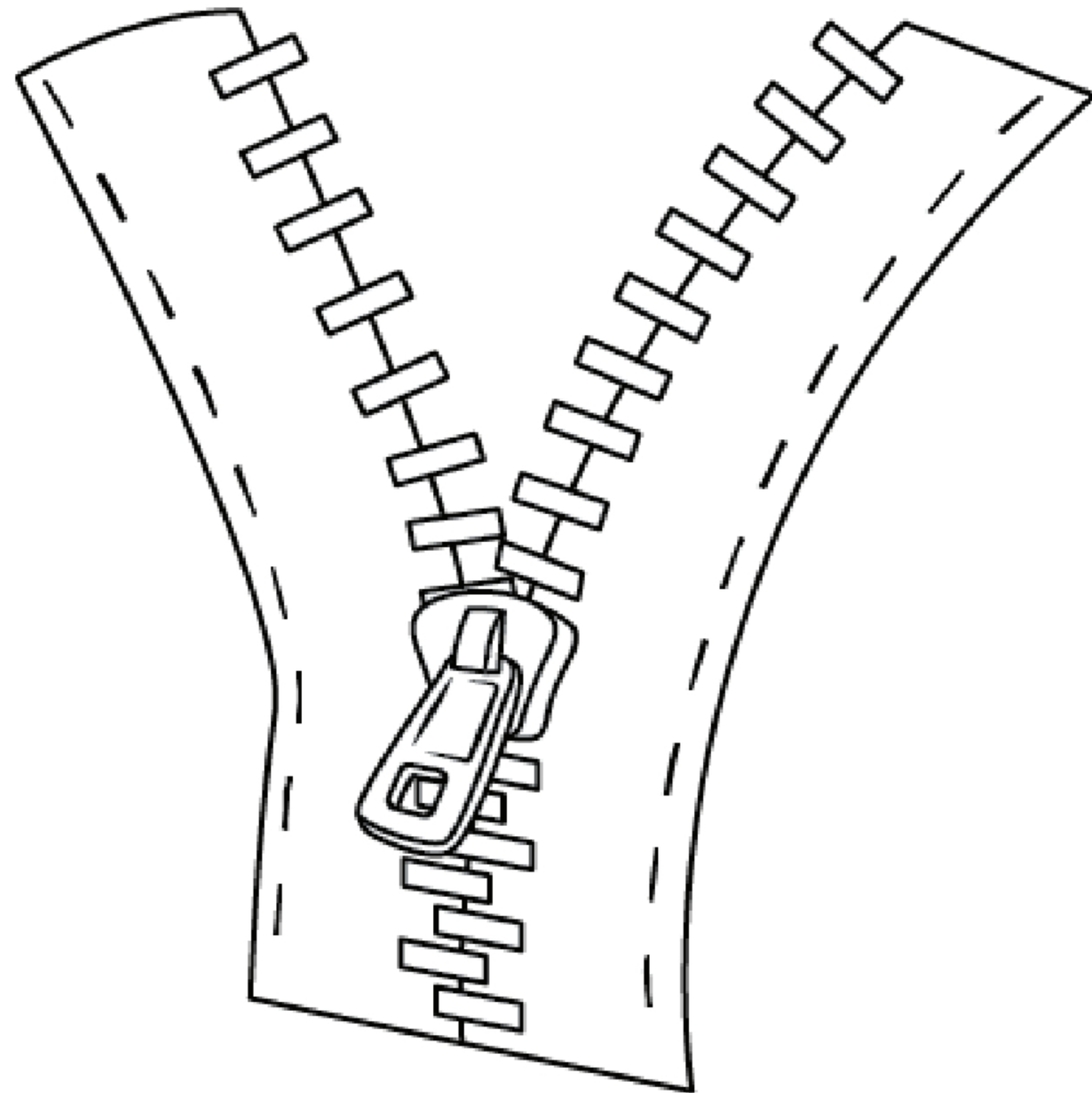

ZIPPER

ZEBRA