

English Made Easy

Learning English through Pictures

VOLUME ONE

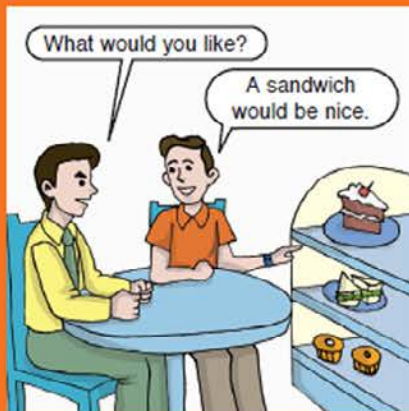
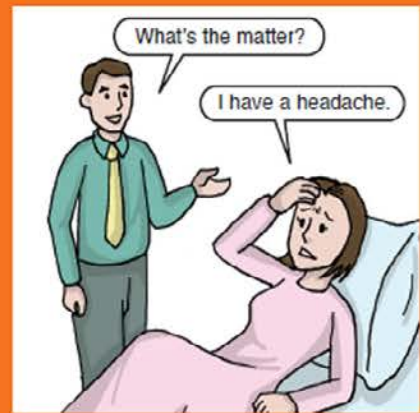
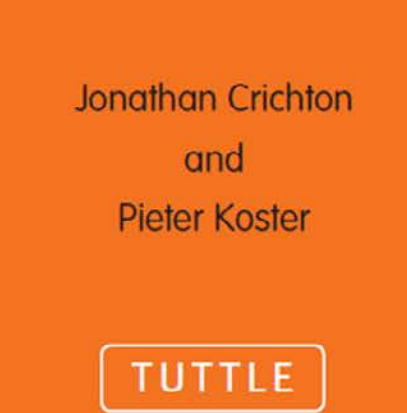

English Made Easy

Learning English Through Pictures

VOLUME ONE

By Jonathan Crichton and Pieter Koster



TUTTLE Publishing

Tokyo | Rutland, Vermont | Singapore

Published by Tuttle Publishing, an imprint of Periplus Editions (HK) Ltd.

www.tuttlepublishing.com

Copyright © 2006 Periplus Editions (HK) Ltd.

All rights reserved. No part of this book may be reproduced or utilized in any form or by any means, electronic or mechanical, including photocopying, recording, or by any information storage or retrieval system, without permission in writing from the publisher.

LCC Card NO. 2006282280

ISBN: 978-1-4629-0557-7 (ebook)

Distributed by:

North America, Latin America & Europe

Tuttle Publishing
364 Innovation Drive
North Clarendon,
VT 05759-9436 U.S.A.
Tel: 1 (802) 773-8930
Fax: 1 (802) 773-6993
info@tuttlepublishing.com
www.tuttlepublishing.com

Japan

Tuttle Publishing
Yaekari Building, 3rd Floor
5-4-12 Osaki, Shinagawa-ku,
Tokyo 141 0032
Tel: (81) 3 5437-0171
Fax: (81) 3 5437-0755
sales@tuttle.co.jp
www.tuttle.co.jp

Asia Pacific

Berkeley Books Pte. Ltd.
61 Tai Seng Avenue
#02-12 Singapore 534167
Tel: (65) 6280-1330
Fax: (65) 6280-6290
inquiries@periplus.com.sg
www.periplus.com

14 13 12 11
10 9 8 7 6 5

Printed in Singapore

TUTTLE PUBLISHING® is a registered trademark of Tuttle Publishing, a division of Periplus Editions (HK) Ltd.

Contents

FUNCTION	GRAMMAR	VOCABULARY
UNIT 1: What's your name? 6		
<ul style="list-style-type: none"> identifying people by name talking about ownership 	<ul style="list-style-type: none"> possessive adjectives negation simple present 	<ul style="list-style-type: none"> common objects family relationships
UNIT 2: That'd be great! 14		
<ul style="list-style-type: none"> giving, accepting and declining invitations 	<ul style="list-style-type: none"> personal pronouns imperatives present continuous 	<ul style="list-style-type: none"> places to visit events
UNIT 3: I'd like you to meet my accountant. 22		
<ul style="list-style-type: none"> introducing people 	<ul style="list-style-type: none"> demonstratives 	<ul style="list-style-type: none"> jobs social relationships
UNIT 4: It's a beautiful day, isn't it? 30		
<ul style="list-style-type: none"> starting conversations 	<ul style="list-style-type: none"> question tags possessive pronouns 	<ul style="list-style-type: none"> common adjectives common adverbs
UNIT 5: Revision and extension 38		
UNIT 6: Would you like something to drink? 48		
<ul style="list-style-type: none"> making, accepting and declining offers 	<ul style="list-style-type: none"> count/uncount nouns open questions 	<ul style="list-style-type: none"> food and drink numbers 1-10
UNIT 7: He's a tour guide. 58		
<ul style="list-style-type: none"> talking about occupations asking for clarification 	<ul style="list-style-type: none"> simple past 	<ul style="list-style-type: none"> occupations
UNIT 8: I'm going to New York. 64		
<ul style="list-style-type: none"> asking about price talking about travel 	<ul style="list-style-type: none"> present perfect duration 	<ul style="list-style-type: none"> days and months money numbers 11-20 transport
UNIT 9: This one is better. 72		
<ul style="list-style-type: none"> asking for and giving opinions agreeing and disagreeing 	<ul style="list-style-type: none"> comparatives and superlatives 	<ul style="list-style-type: none"> food
UNIT 10: Revision and extension 82		

FUNCTION	GRAMMAR	VOCABULARY
UNIT 11: What's the matter? 92		
<ul style="list-style-type: none"> • greetings and farewells • talking about health 	<ul style="list-style-type: none"> • obligation 	<ul style="list-style-type: none"> • parts of the body • common ailments
UNIT 12: I live in the big house. 100		
<ul style="list-style-type: none"> • talking about addresses and locations 	<ul style="list-style-type: none"> • future with will • spatial prepositions 	<ul style="list-style-type: none"> • locators • numbers over 20
UNIT 13: How much is this purse? 110		
<ul style="list-style-type: none"> • buying goods and services • inquiring about health 	<ul style="list-style-type: none"> • some/any • necessity 	<ul style="list-style-type: none"> • common containers • musical instruments • rooms
UNIT 14: It's the second street on the left. 122		
<ul style="list-style-type: none"> • asking for and giving directions 	<ul style="list-style-type: none"> • open questions • directional prepositions 	<ul style="list-style-type: none"> • common institutions • colors • ordinal numbers
UNIT 15: Revision and extension 132		
UNIT 16: She bought a cake. 142		
<ul style="list-style-type: none"> • talking about the past 	<ul style="list-style-type: none"> • simple past • regular and irregular verbs • present continuous 	<ul style="list-style-type: none"> • activities and processes
UNIT 17: They're working in the garden. 150		
<ul style="list-style-type: none"> • using the telephone 	<ul style="list-style-type: none"> • gerunds • present and past continuous • before/after 	<ul style="list-style-type: none"> • telephone language
UNIT 18: What's the time? 162		
<ul style="list-style-type: none"> • talking about time • making appointments 	<ul style="list-style-type: none"> • timetable future 	<ul style="list-style-type: none"> • times • emotions
UNIT 19: You're not allowed to park here. 172		
<ul style="list-style-type: none"> • using public transport • asking for, giving and refusing permission 	<ul style="list-style-type: none"> • prohibition • quantifiers 	<ul style="list-style-type: none"> • transport • time measurements
UNIT 20: Revision and extension 182		
Index 191		

Preface

In an increasingly international world, being able to communicate in English is nowadays a necessity in social, professional and business life. Competence in English creates an increasing range of business, travel and leisure opportunities, opening doors to international communication.

English Made Easy is a breakthrough in English language learning – imaginatively exploiting how pictures and text can work together to create understanding and help learners learn more productively.

English Made Easy gives learners easy access to the vocabulary, grammar and functions of English as it is actually used in a comprehensive range of social situations. Self-guided students and classroom learners alike will be delighted by the way they are helped to progress easily from one unit to the next, using the combinations of pictures and text to discover for themselves how English works.

The *English Made Easy* method is based on a thorough understanding of language structure and how language is successfully learned. The authors are experienced English language teachers with strong backgrounds in language analysis and language learning. The *English Made Easy* team is confident that the books represent a significant development in English language learning.

— Professor Christopher N. Candlin

Using this book

This book is easy to use. You will learn how to speak English by looking at the pictures and words on each page. The pictures explain the words.

The table of contents tells you what you will learn in each of the twenty units. You can use this table to look up any particular points you want to learn or practice.

The twenty units are arranged in groups of five. The first four units present language and give you opportunities to practice as you learn. The first page of each unit has a list of all the words and phrases you will learn in that unit, together with a pronunciation guide. At the end of each unit there is an interesting story which uses the language you have just learned.

The fifth unit in each group gives you the opportunity to revise the language in the first four units and to use it in different situations. The exercises are easy to understand and there is an answer key at the end of the unit.

At the end of the book there is an index which contains all the words and phrases in the book. It is not a dictionary. It refers you to the unit in which that language first appears so that you can “discover” the meaning of the word by seeing it in context.

UNIT 1: What's your name?

a [ei, ə]
the [ðə]

book [buk]
camera [kæm'ərə]
car [kɑ:r]
house [haus]
key [ki:]
laptop [læp'ta:p]
mobile phone [moub'əl foun]
pen [pen]
purse [pə:rs]
wallet [wa:l'it]
watch [wa:tʃ]

whose [hu:z]

her [hə:r]
his [hiz]
my [mai]
our [au'ə:r]
their [ðe:r]
your [ju:r]

My name's ... [mai neimz]
What's your name? [wɒts ju:r neim]

yes [jes]
no [nou]
I don't know. [ai daunt nou]

family [fæm'li:]

husband [hʌz'bænd]
wife [waif]

father [fa:'ðə:r]
mother [mʌð'ə:r]

son [sʌn]
daughter [dɔ:t'ə:r]

brother [brʌð'ə:r]
sister [sis'tə:r]

name [neim]

is [iz]
isn't [iz'ənt]

it [it]
this [ðis]
what [wɒt]

this is [ðis iz]
it's [its]

Excuse me. [eksku:z' mi:]
Thank you. [θæŋk ju:]



what is = what's



my name is = my name's

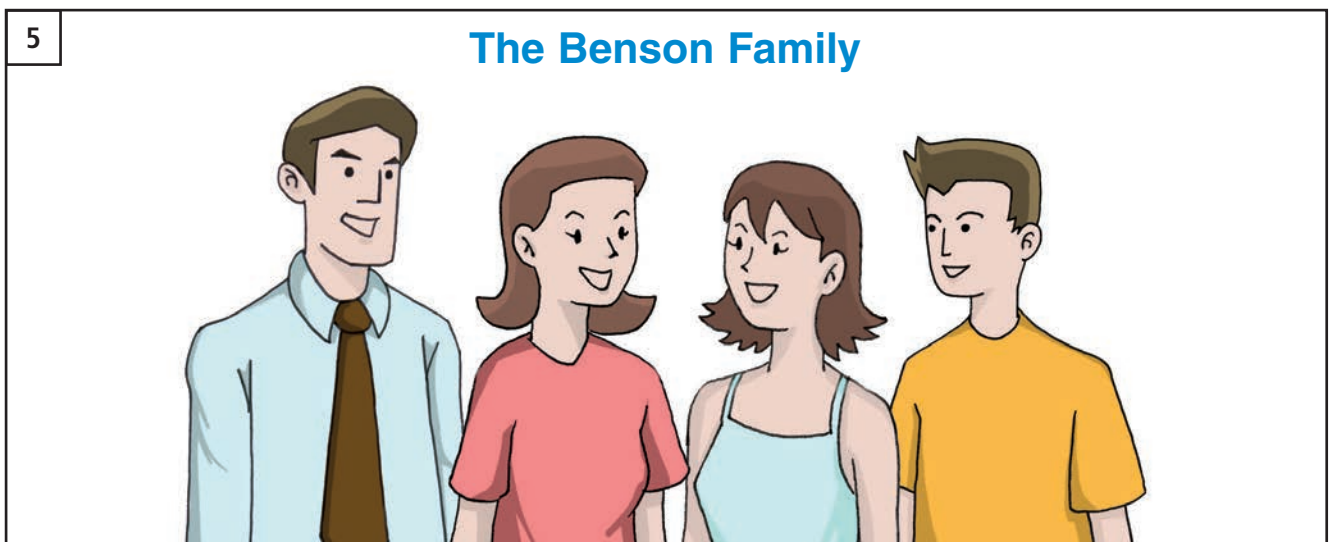
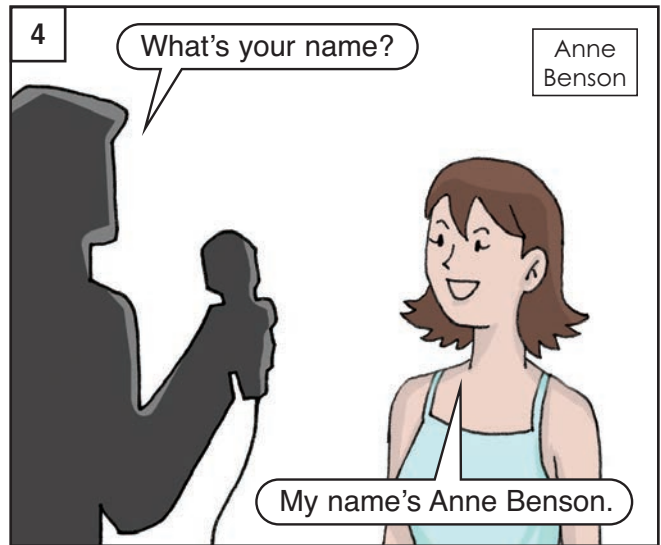
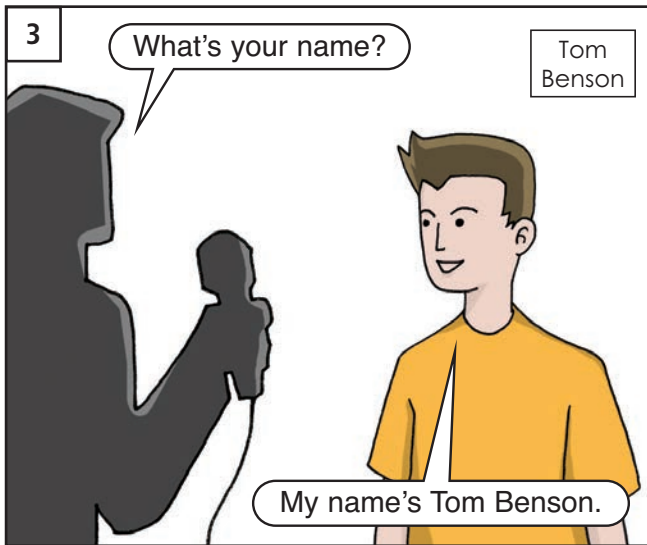
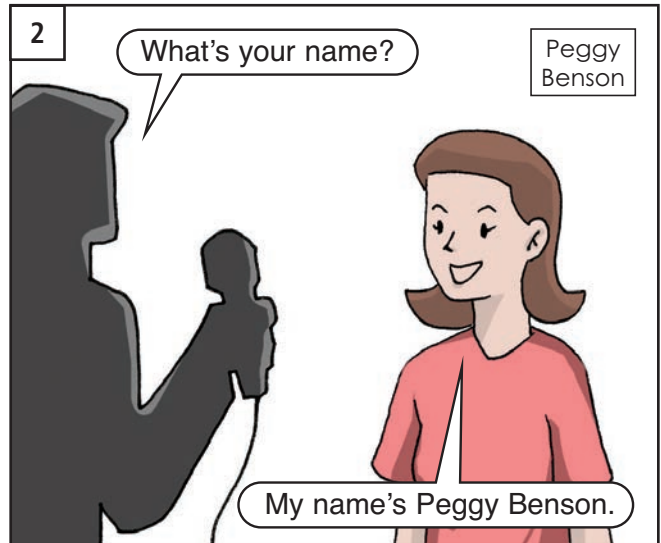
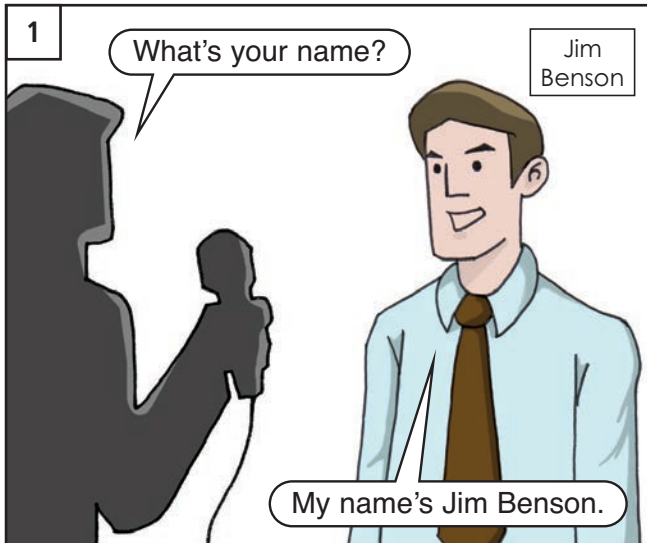

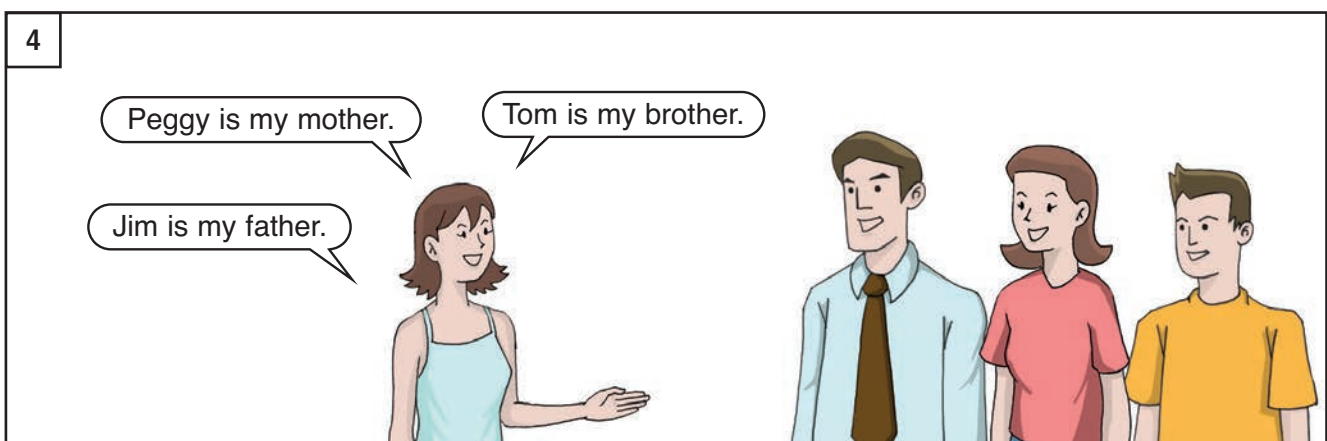
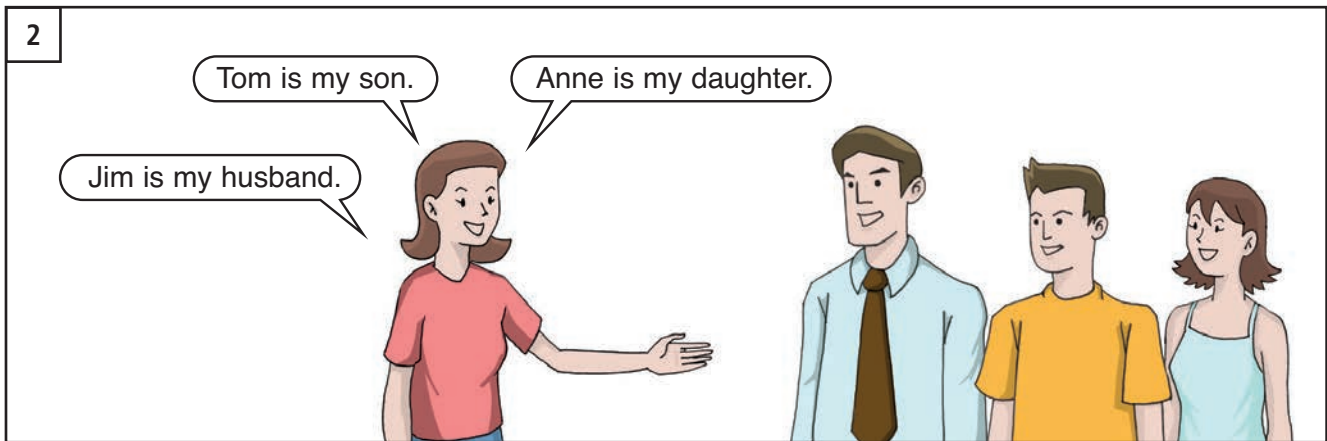
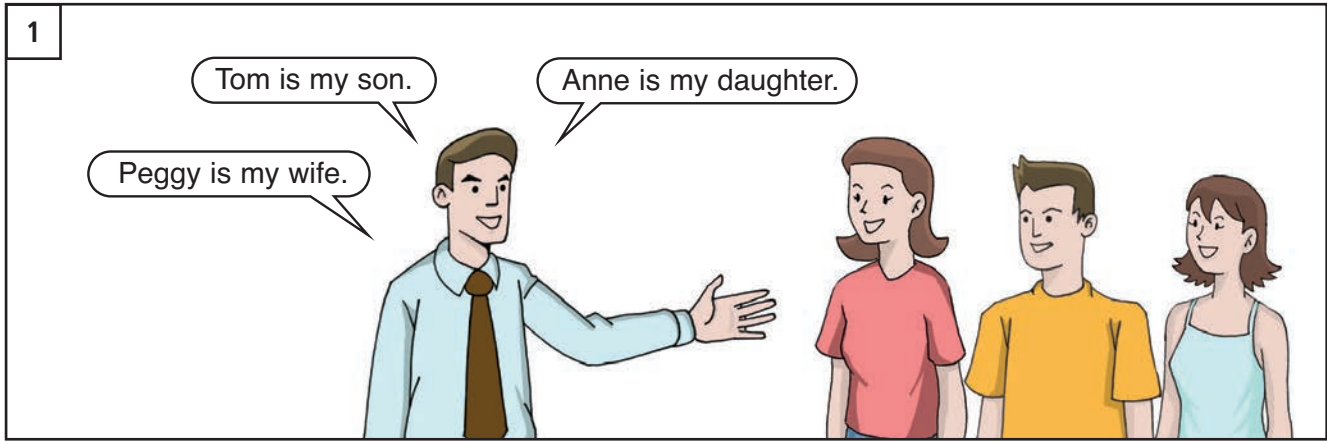

UNIT 1

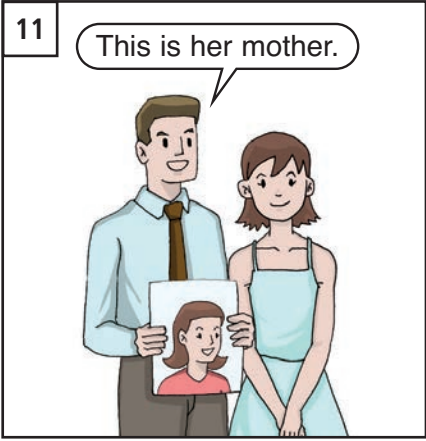
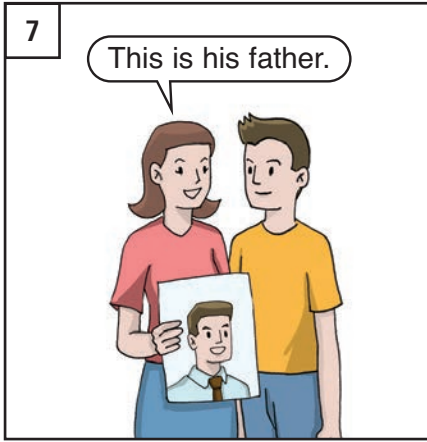
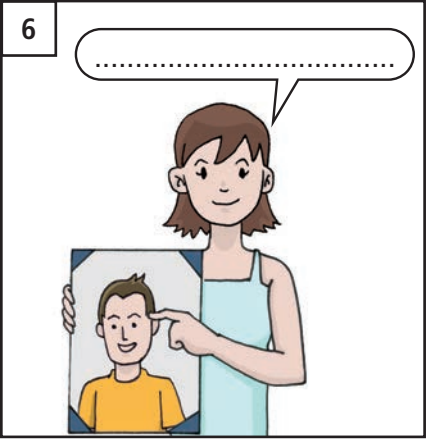
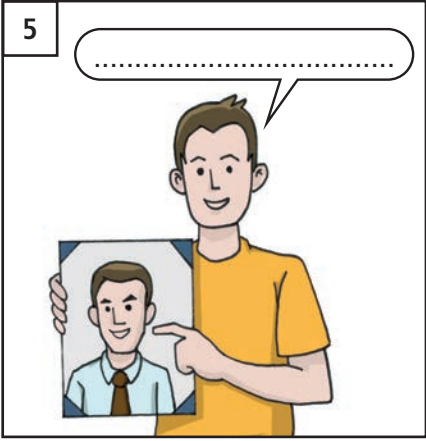
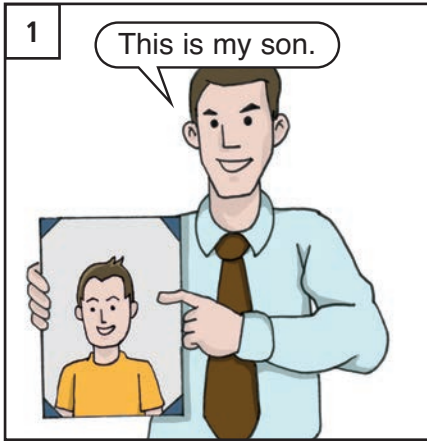

What's your name?





UNIT 1

 **it is =**  **it's**

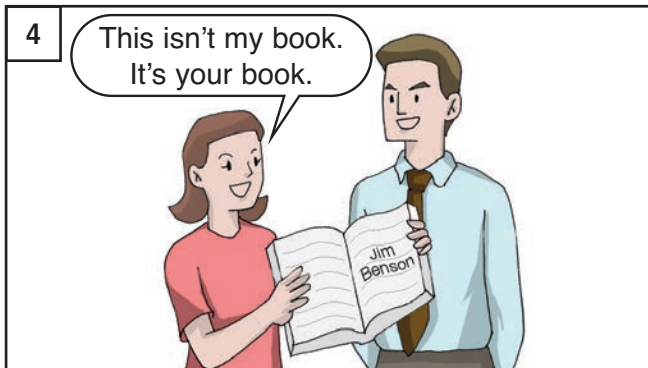
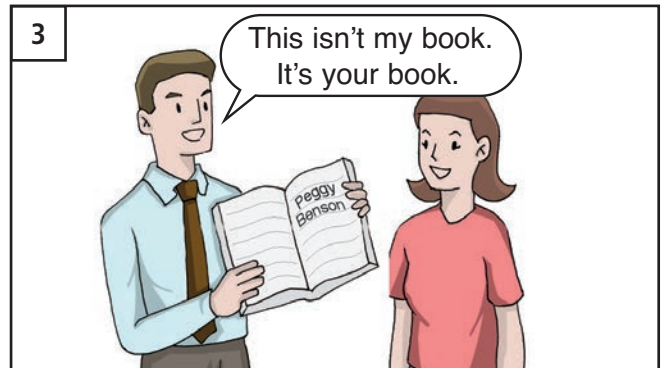
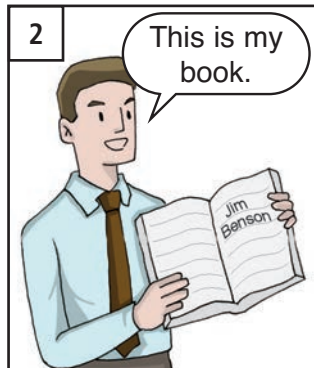
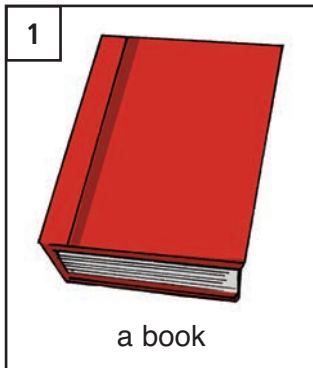
 **is not =**  **isn't**



 **do not =**  **don't**

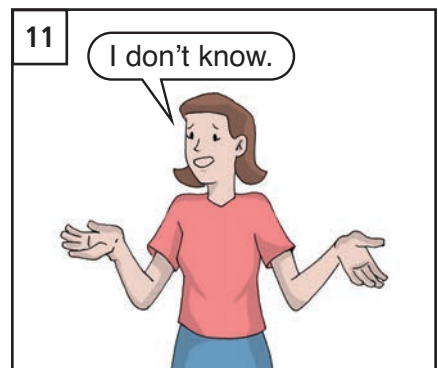
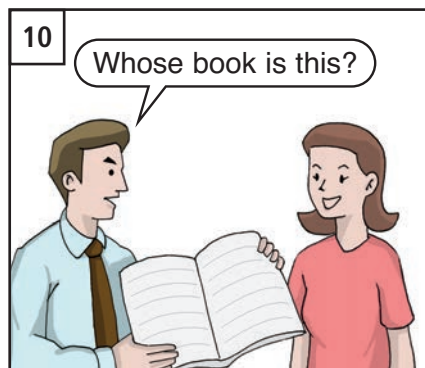
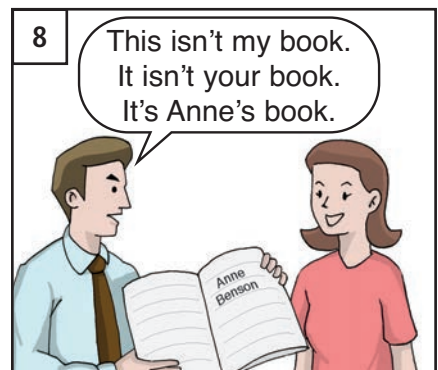
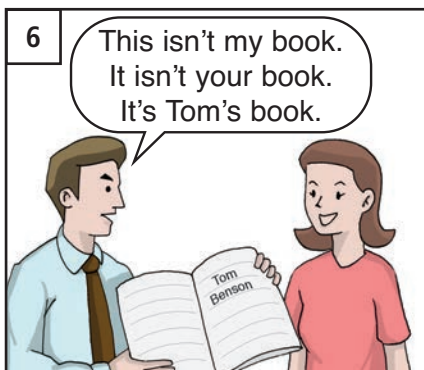

What's your name?

1



a camera

2



a mobile phone

3



a key

4



a pen

5



a house

6

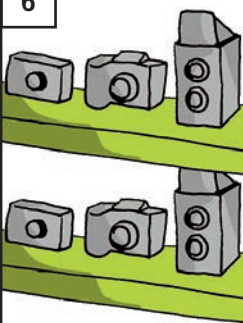

cameras

7



mobile phones

8



keys

9

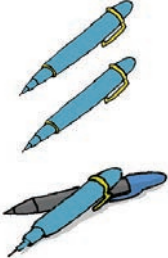

pens

10



houses

11



a laptop

12



a watch

13



a wallet

14



a purse

15



a car

16



laptops

17



watches

18



wallets

19

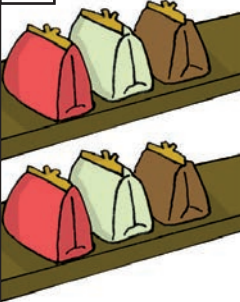

purses

20



cars

UNIT 1

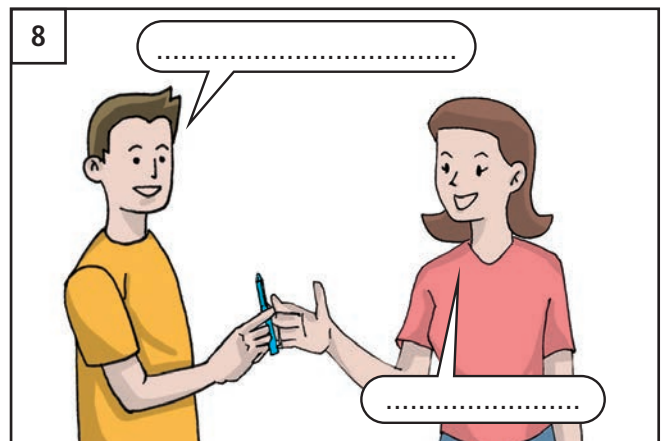
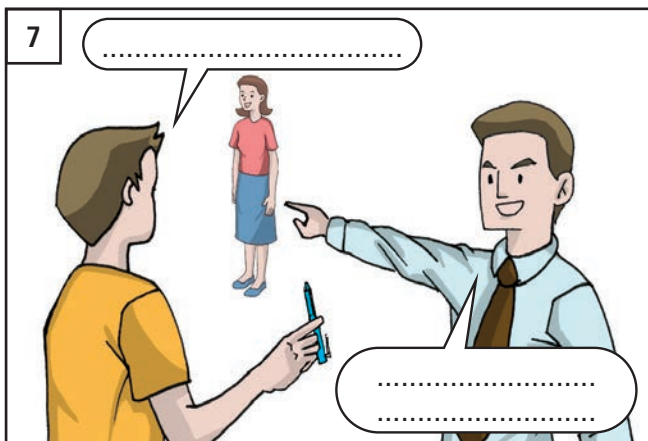
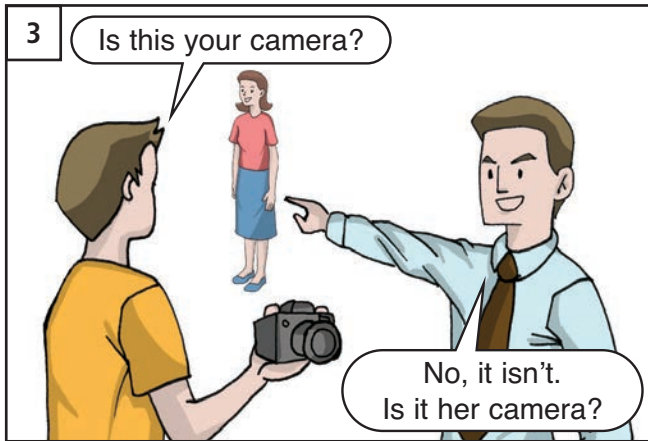

The Bensons

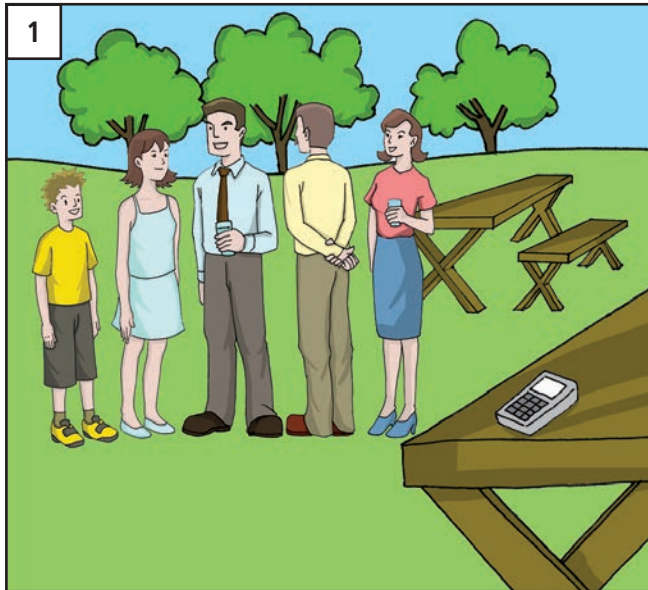

UNIT 2: That'd be great!

art gallery [ɑ:rt gæl'ə:ri:]

beach [bi:tʃ]

concert [kɑ:n'sə:rt]

dinner [din'ə:r]

lunch [lʌntʃ]

meeting [mi:'tiŋ]

movies [mu:'vi:z]

picnic [pik'nik]

party [pɑ:r'ti:]

restaurant [res'tɔ:rənt]

theater [θi:'ətə:r]

market [mɑ:r'kit]

bring [brɪŋ]

bringing [brɪŋ'ɪŋ]

can [kæn]

come [kʌm]

coming [kʌm'ɪŋ]

go [ɡoʊ]

going [ɡoʊ'ɪŋ]

take [teɪk]

taking [teɪk'ɪŋ]

know [noʊ]

How about...? [hau əbaʊt']

let's [lets]

Would you like to come to... ?

[wʊd ju: laɪk tu: kʌm tu:]

Sure. [ʃu:r]

I'd love to. [aɪd lʌv tu:]

That'd be great. [ðætəd bi:greɪt]

OK. [oukeɪ']

I'd love to but I can't. [aɪd lʌv tu: bʌt aɪ kənt]

I'm afraid I can't. [aɪm əfreɪd' aɪ kənt]

Sorry, I can't. [sɑ:r'i: aɪ kənt]

door [dɔ:r]

enter [en'tɔ:r]

exit [eg'zɪt]

in [ɪn]

out [aʊt]

to [tu:]

am [æm]

are [ɑ:r]

I [aɪ]

you [ju:]

he [hi:]

she [ʃi:]

we [wi:]

they [ðeɪ]

me [mi:]

you [ju:]

him [hɪm]

her [hɜ:r]

us [ʌs]

them [ðem]

who [hu:]

but [bʌt]



who is = who's

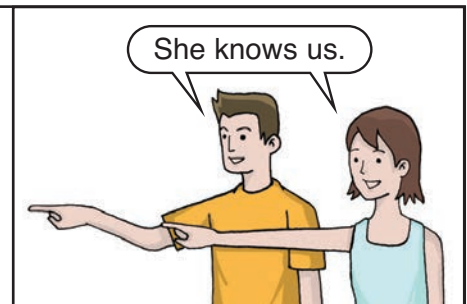
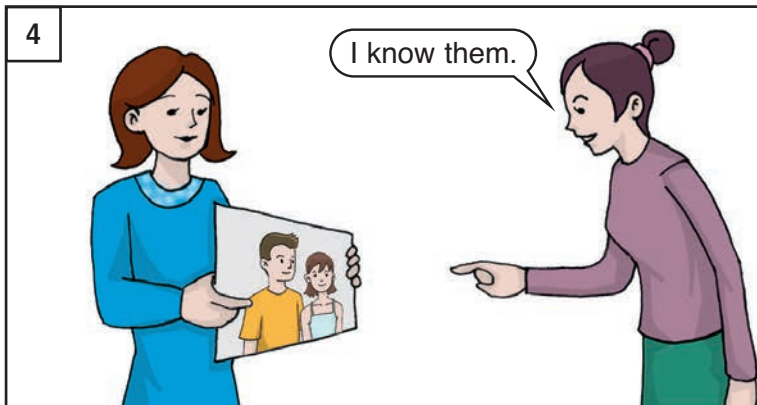
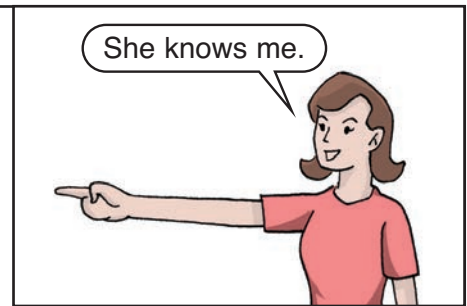
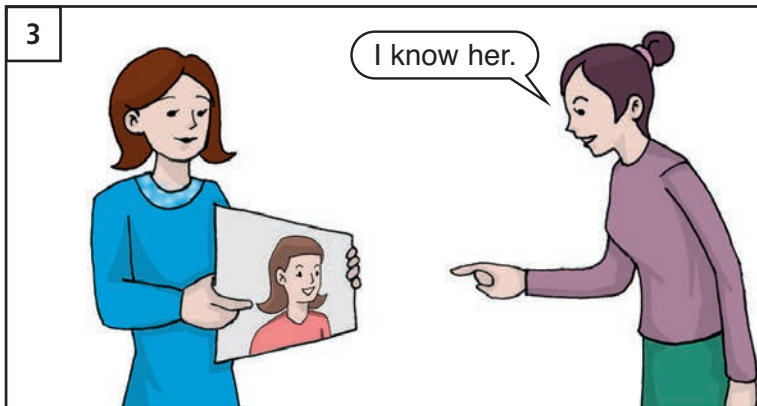
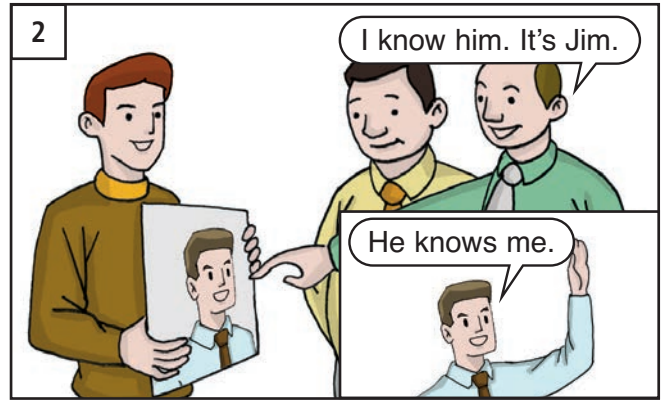
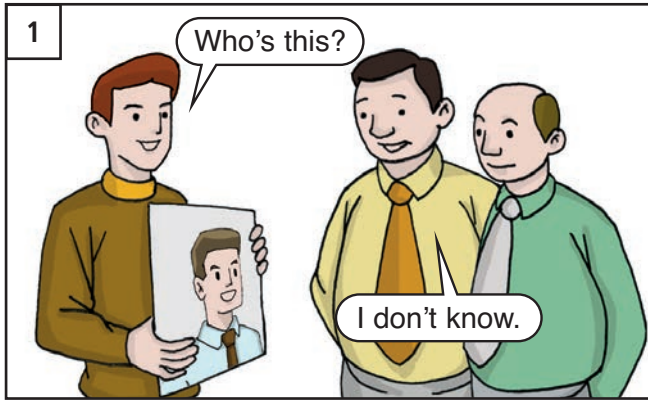

UNIT 2

 I am = I'm

 he is = he's

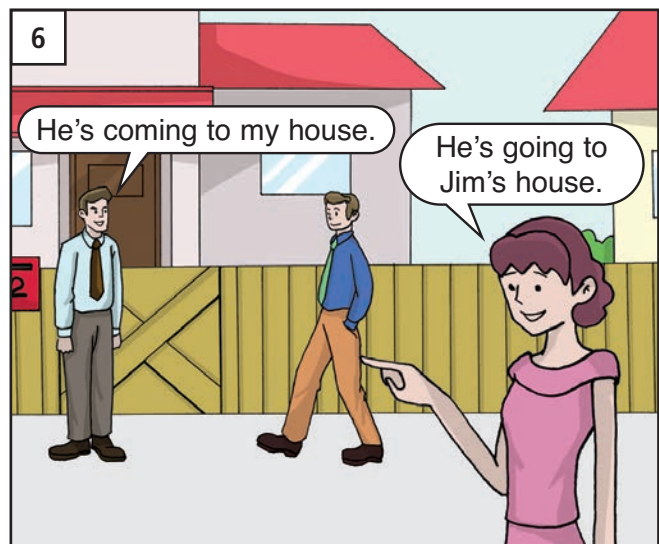
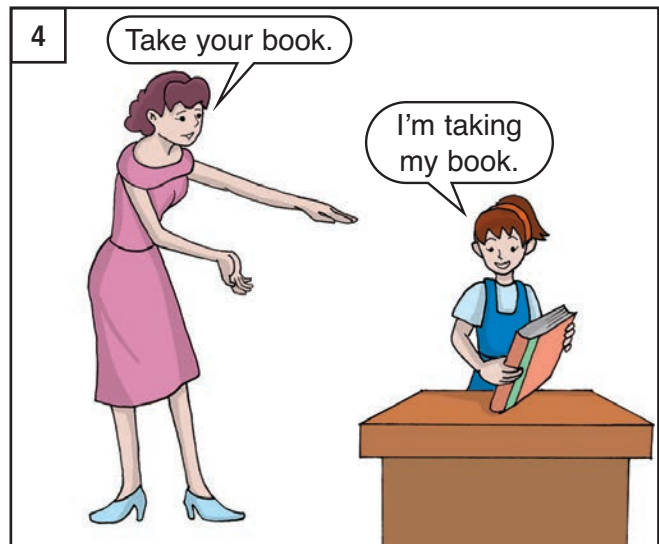
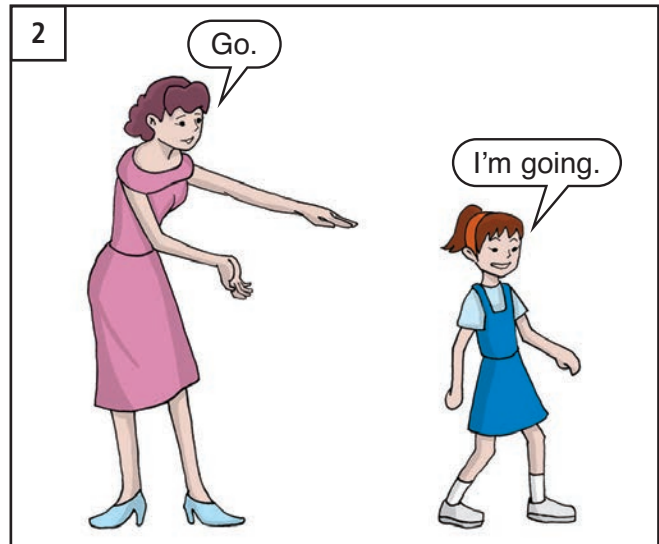
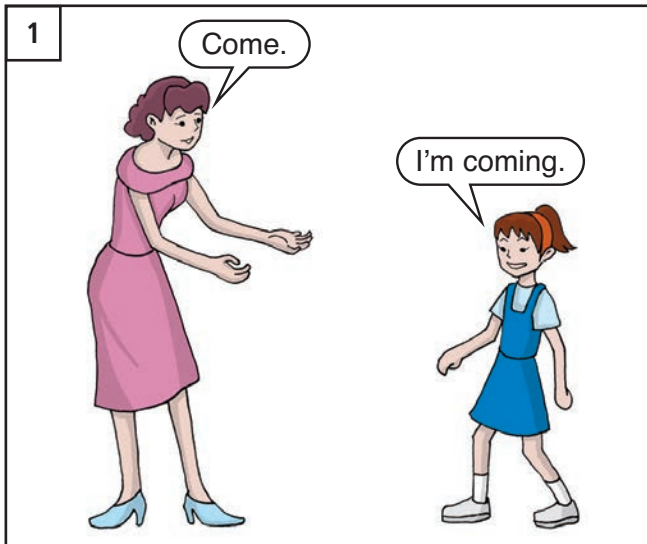



they are = they're



we are = we're



she is = she's

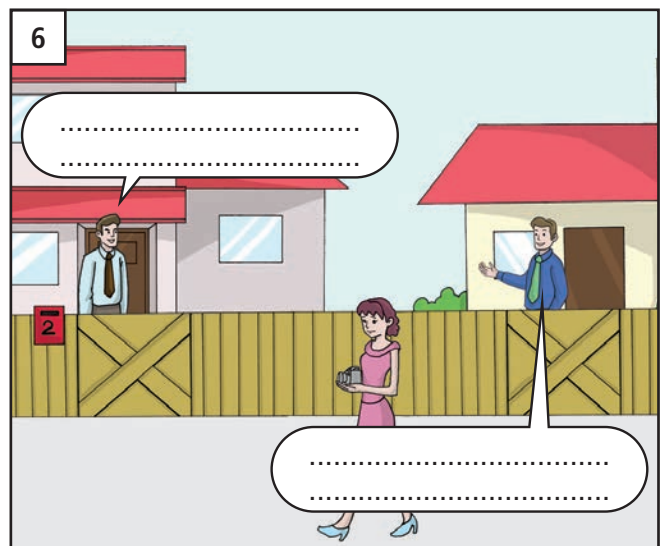
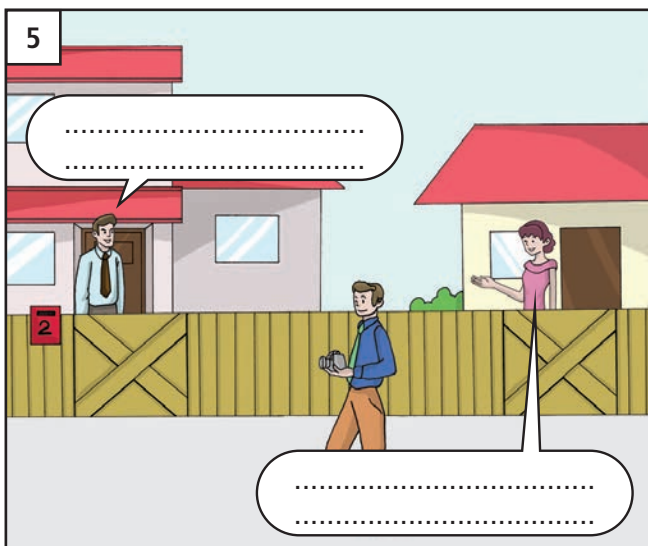
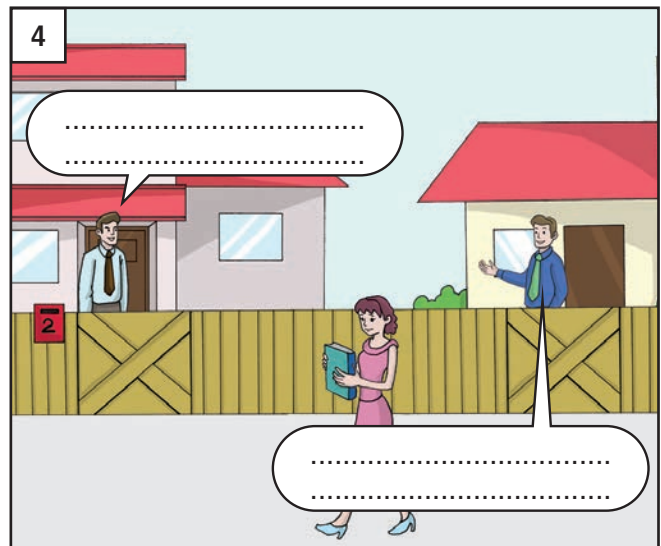
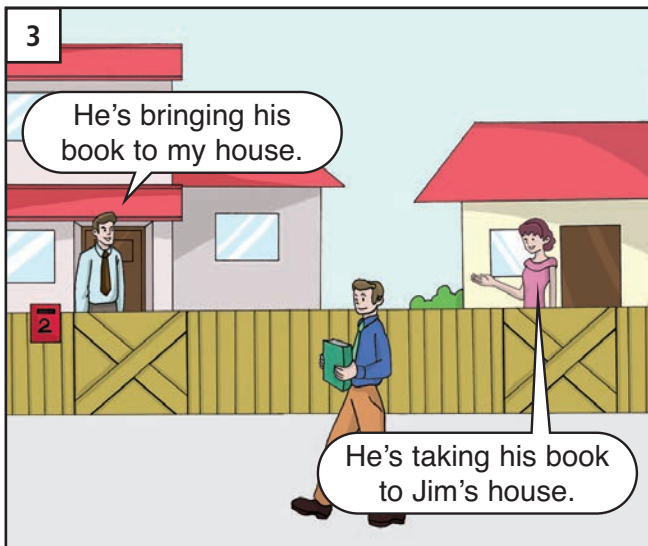
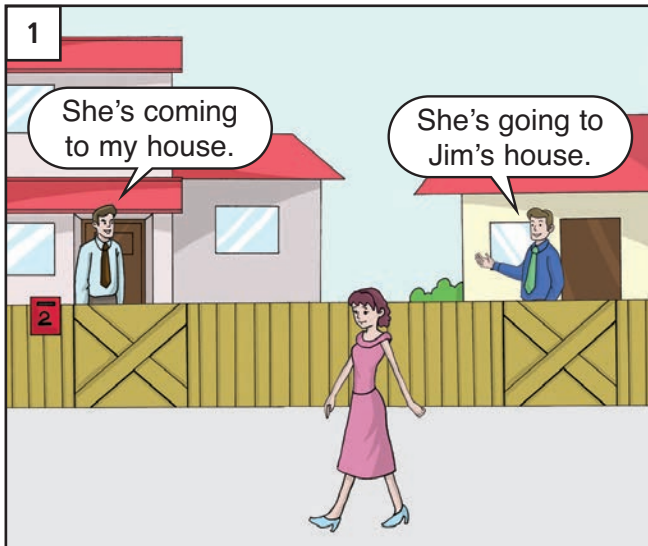

UNIT 2



that would = that'd



I would = I'd



cannot = can't

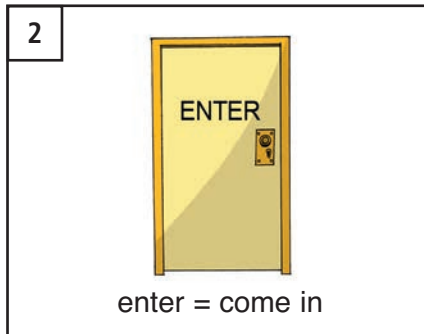
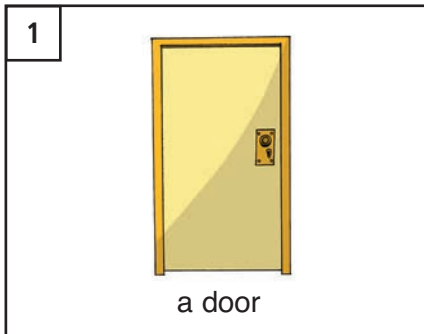

That'd be great!

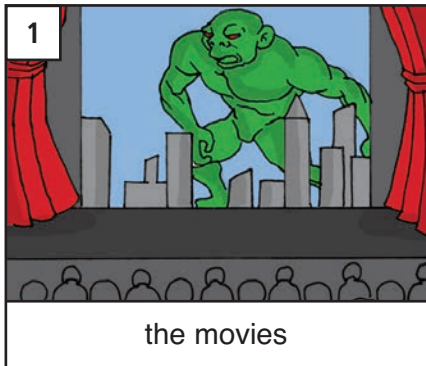

the movies

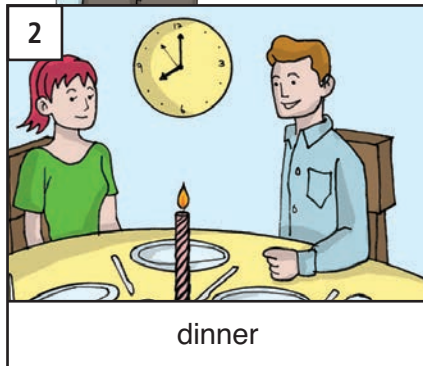

dinner

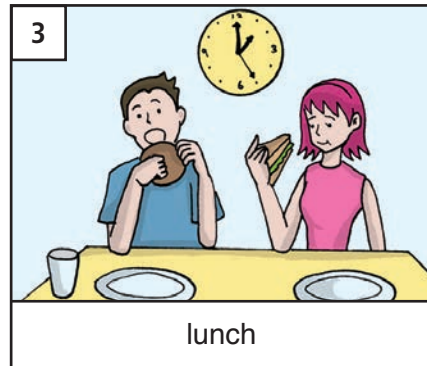

lunch

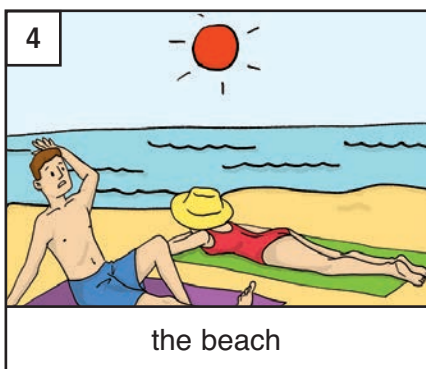

the beach

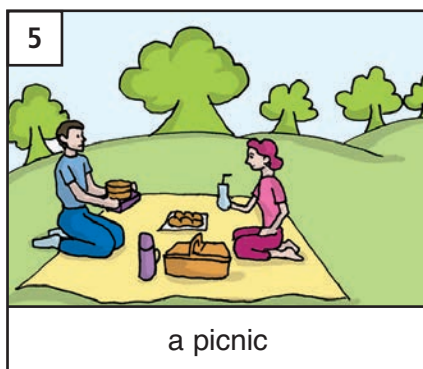

a picnic

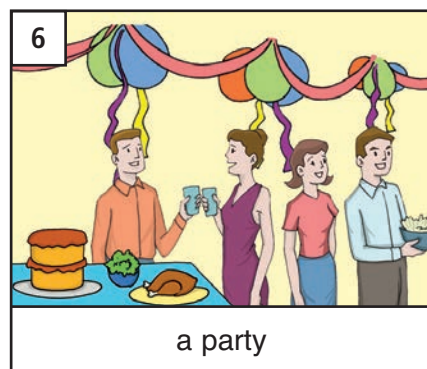

a party

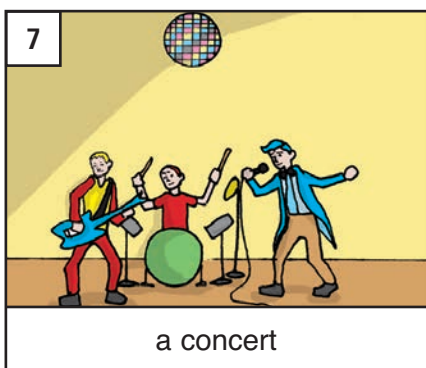

a concert



a market

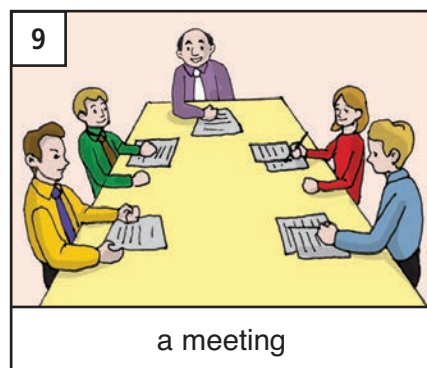

a meeting

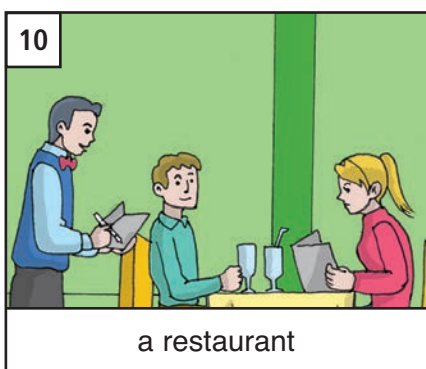

a restaurant

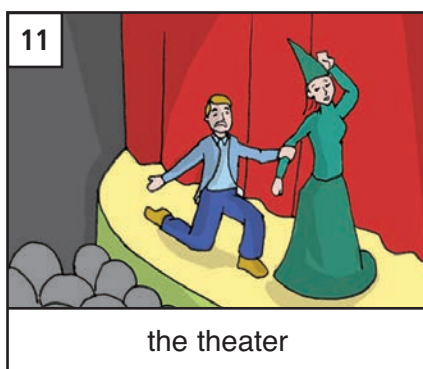

the theater

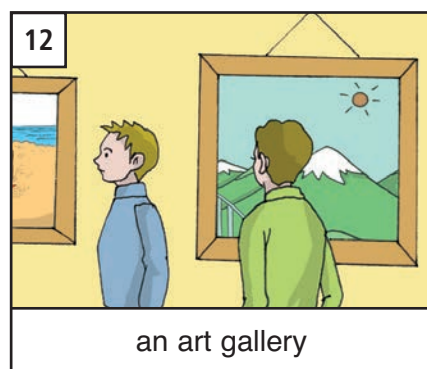

an art gallery

UNIT 2

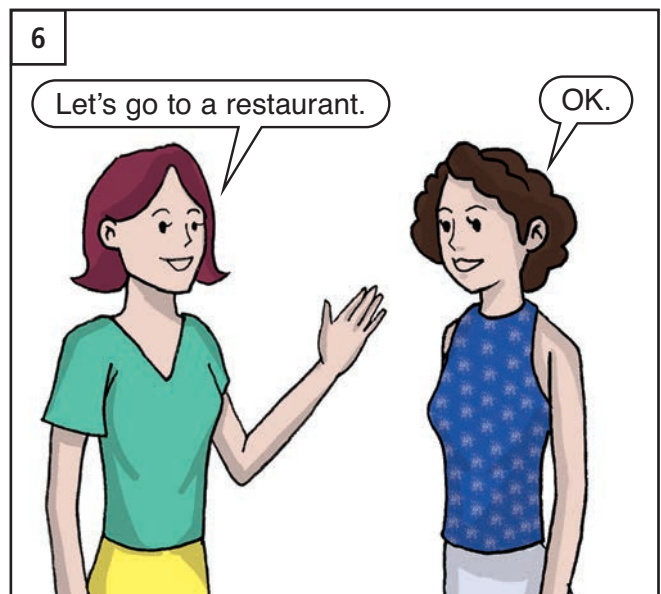
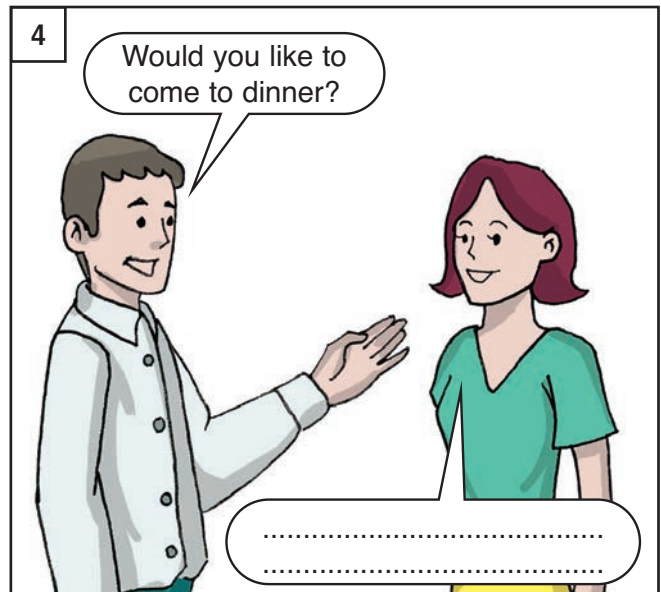
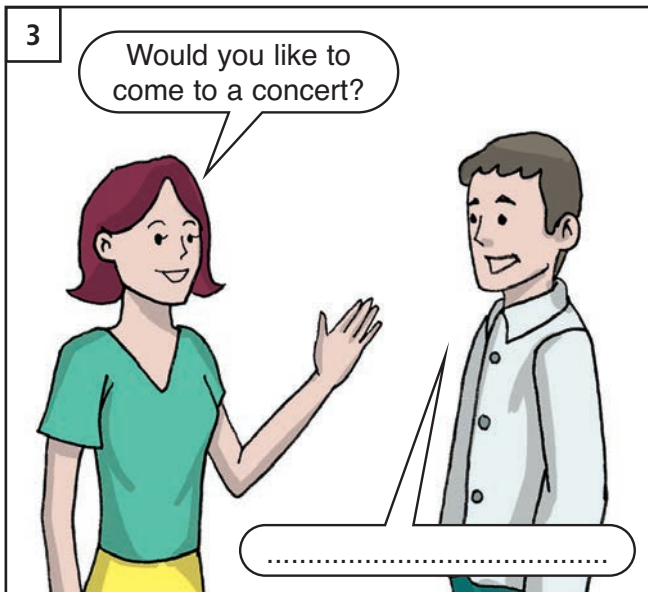
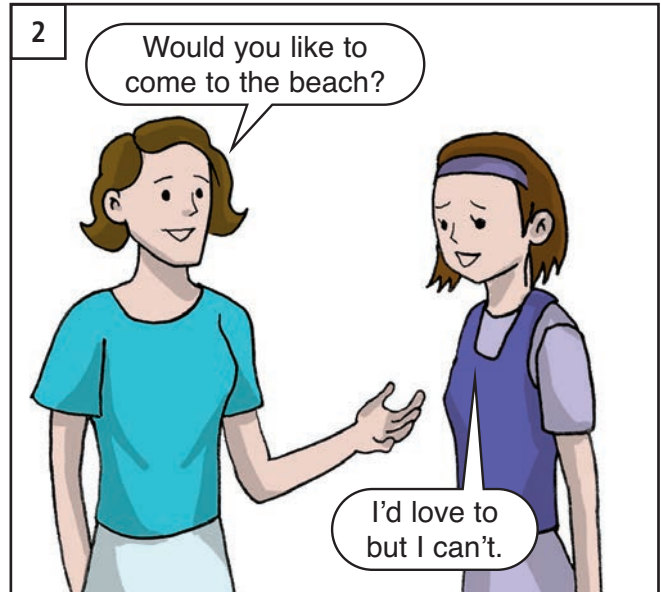
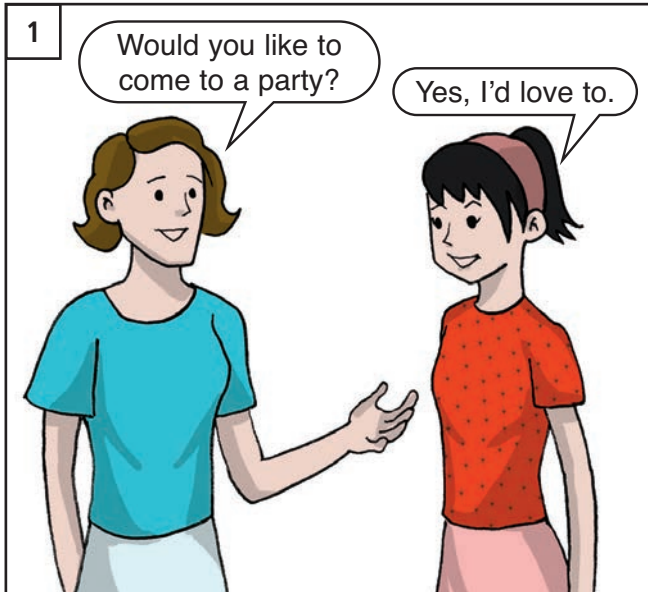

The Bensons



he would = he'd

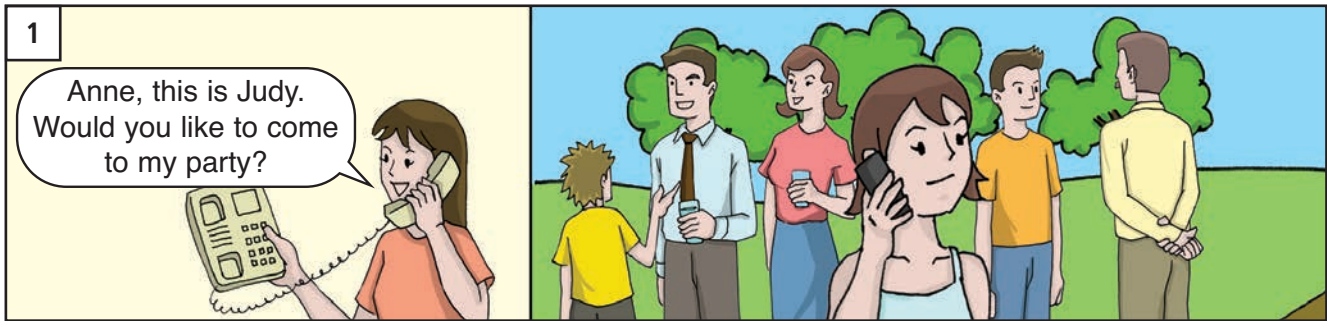

UNIT 3: I'd like you to meet my accountant.

meet [mi:t]

met [met]

accountant [əkaun'tənt]

colleague [ka:l'i:g]

friend [frend]

teacher [ti:tʃə:r]

manager [mæn'idʒə:r]

neighbor [neib'ə:r]

secretary [sek'rite:ri:]

Have you met...? [hæv ju: met]

I'd like you to meet... [aid laik ju: tu: mi:t]

Hi. []

No, I haven't. [nou ai hæv'ənt]

Good to meet you. [gud tu: mi:t ju:]

here [hi:r]

that [ðæt]

there [ðe:r]

these [ði:z]

those [ðouz]

where [we:r]

looks like [luks laik]

I'd like [aid laik]



where is = where's



that is = that's

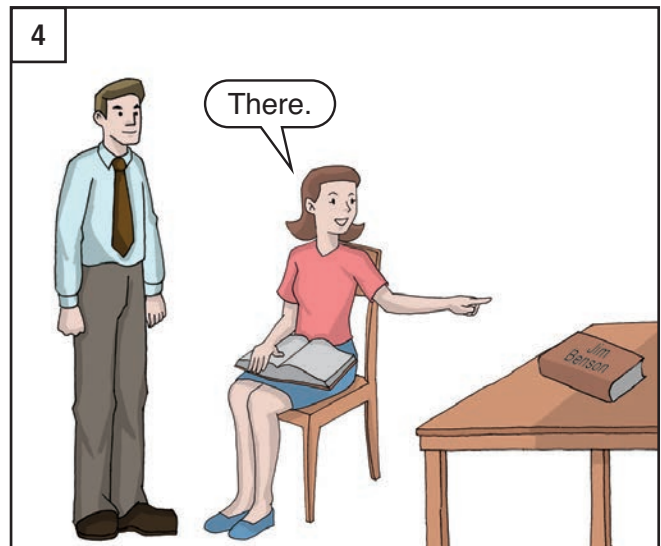
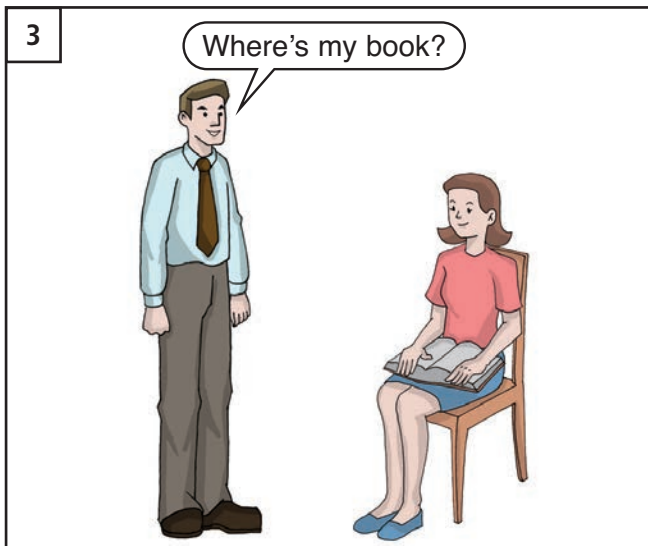
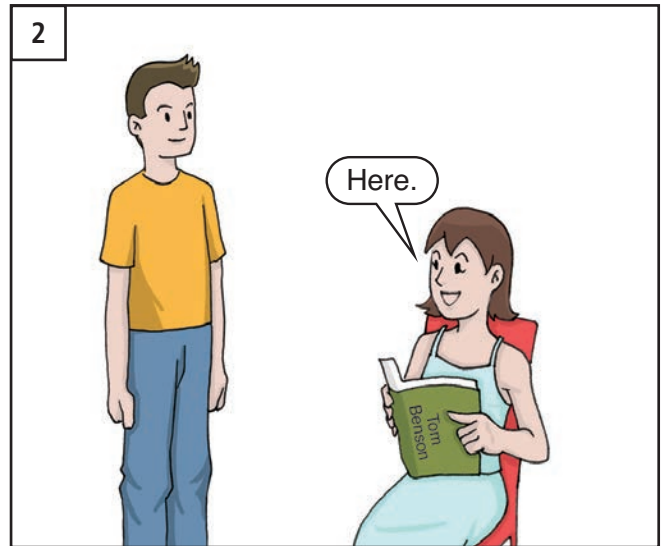
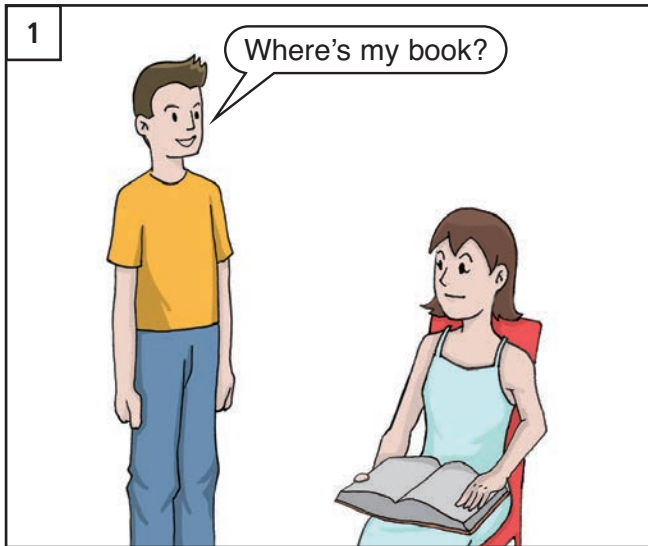

UNIT 3

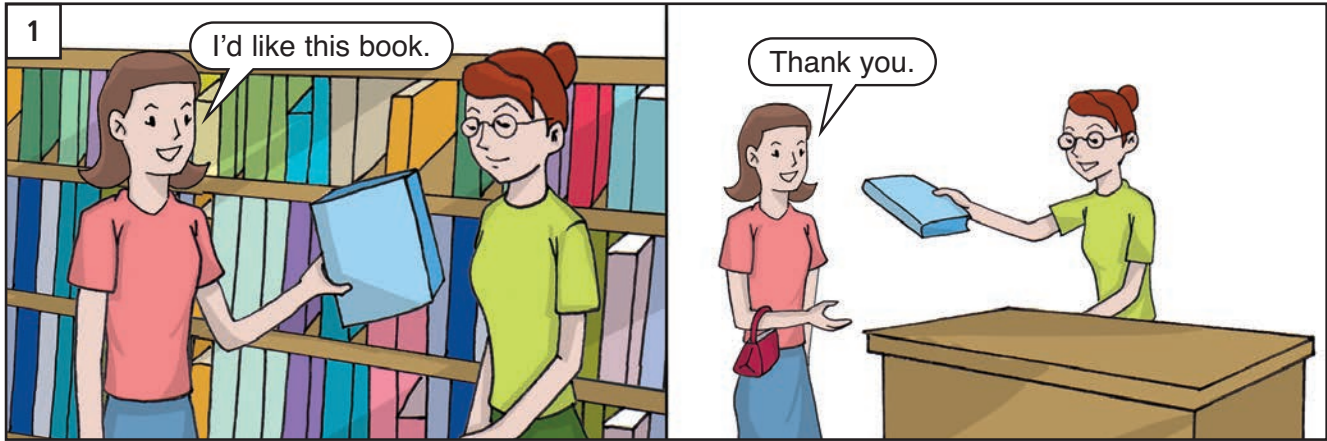

I'd like you to meet my accountant.

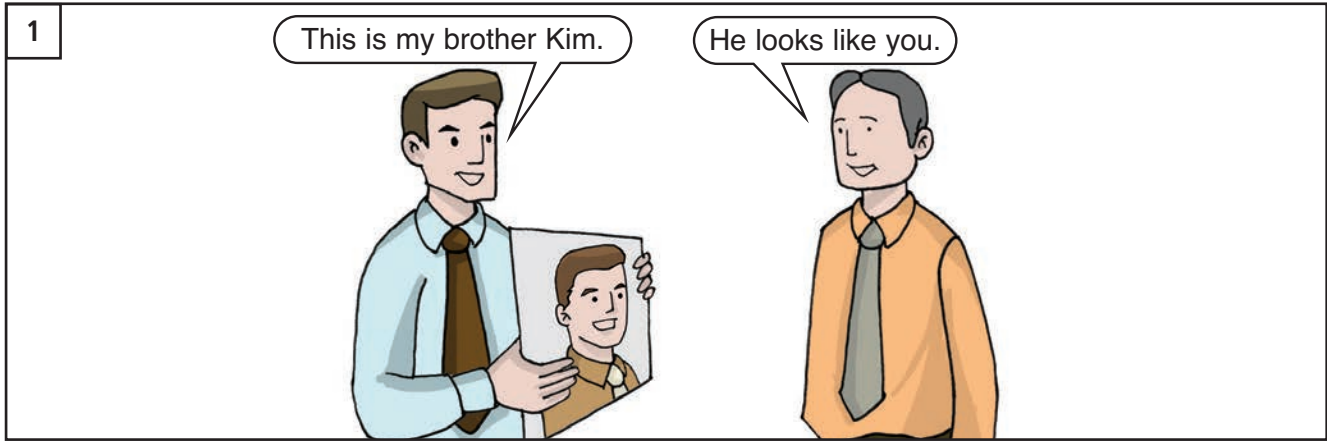

UNIT 3

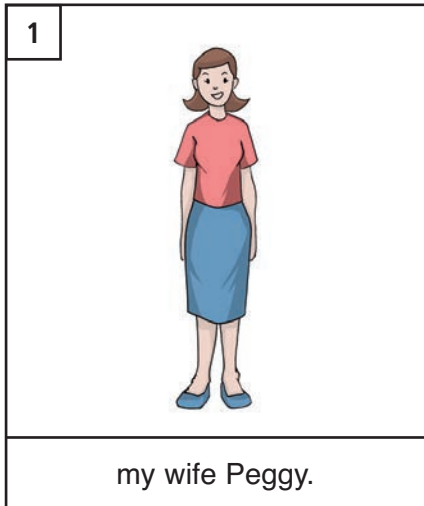

my wife Peggy.

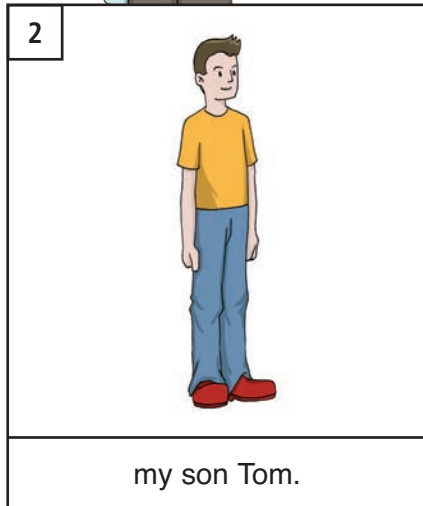

my son Tom.



my neighbor John.



my secretary Janice.



my accountant Henry.



my manager Mr. Lee.

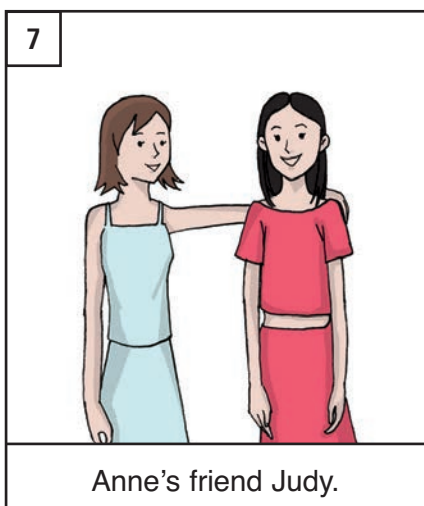

Anne's friend Judy.



Tom's teacher Mrs Cooper.



my colleague David.

I'd like you to meet my accountant.

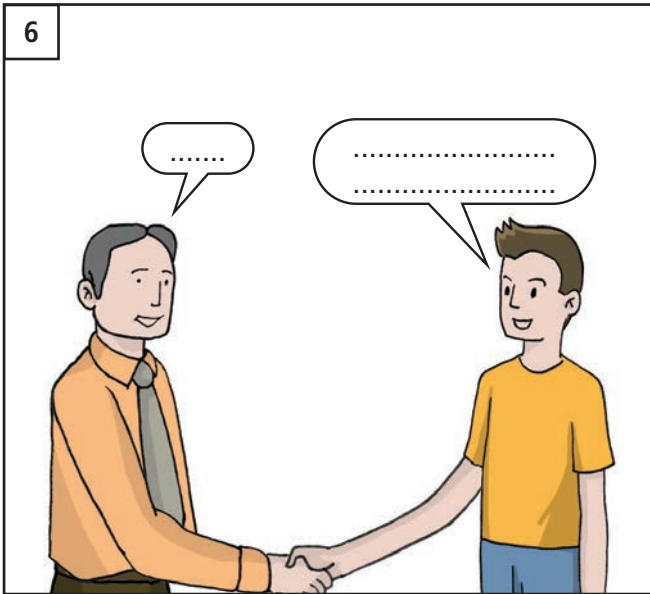
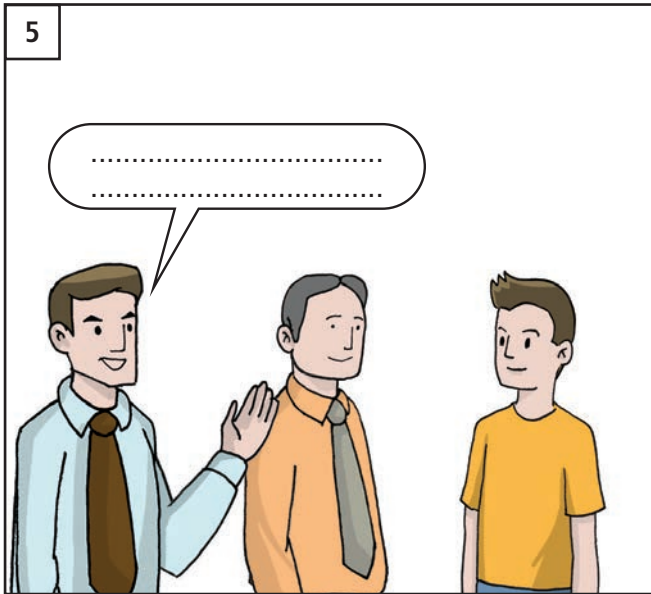
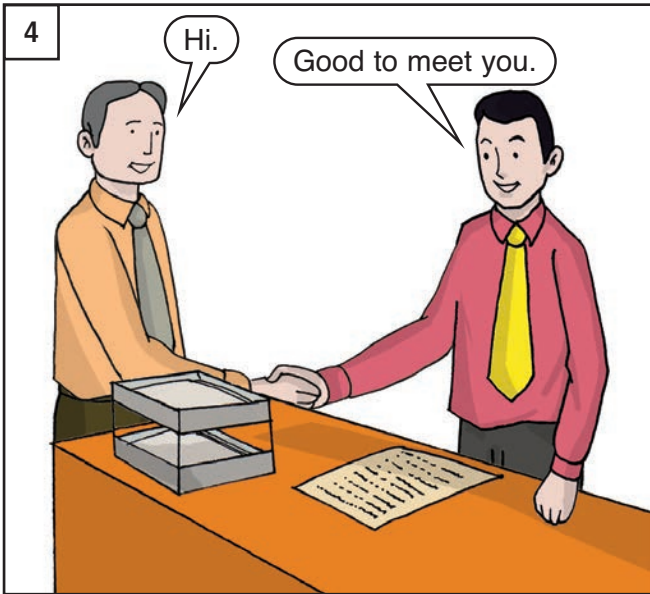
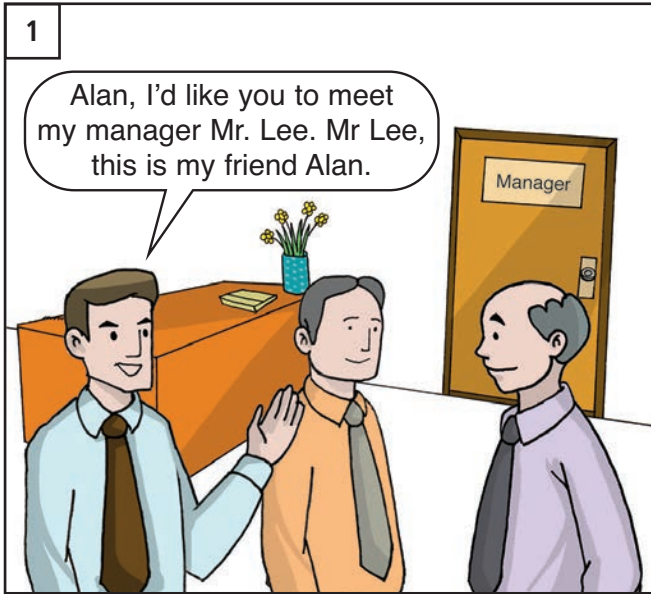



have not = haven't



The Bensons

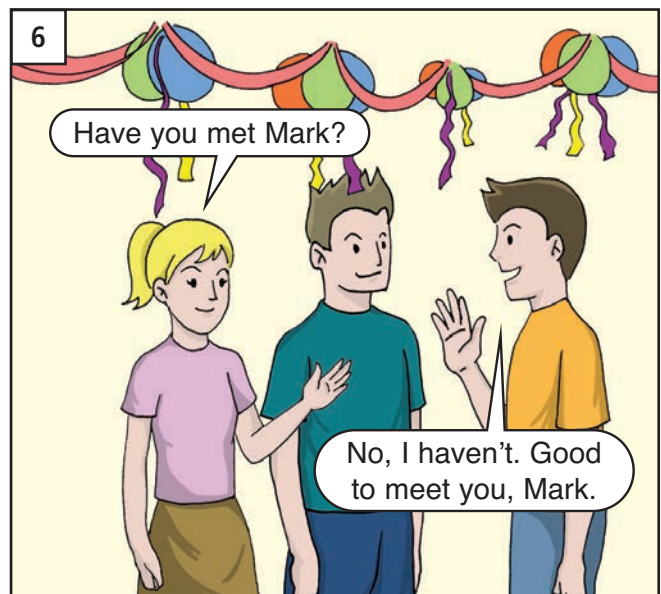
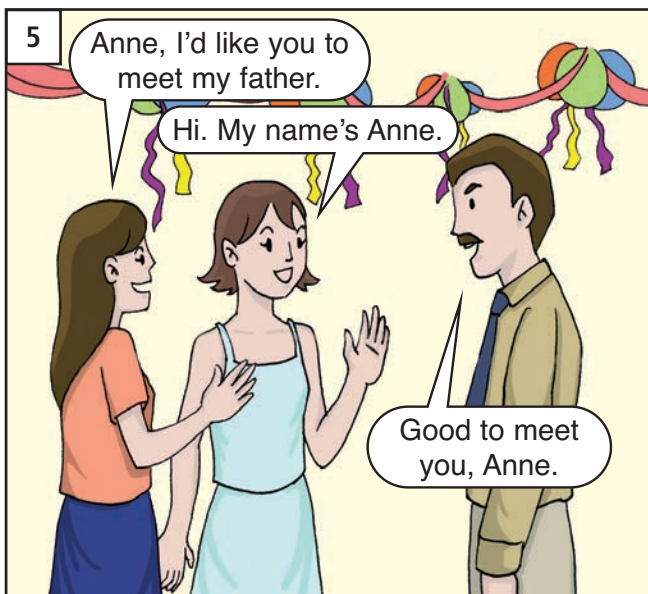
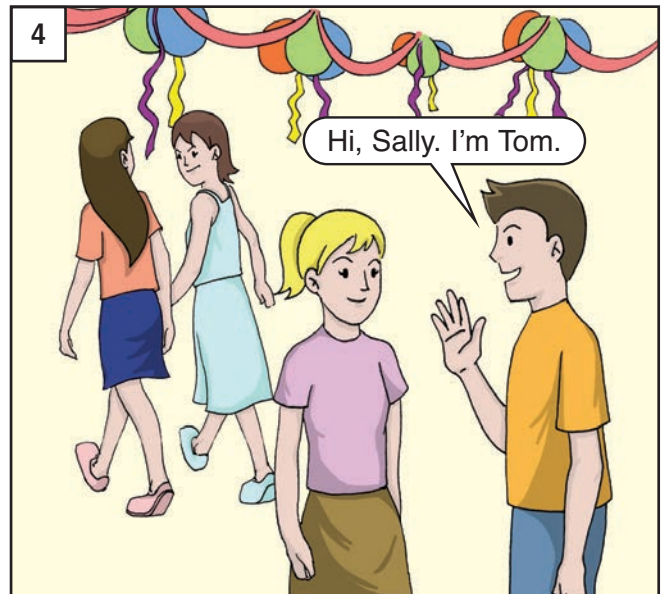
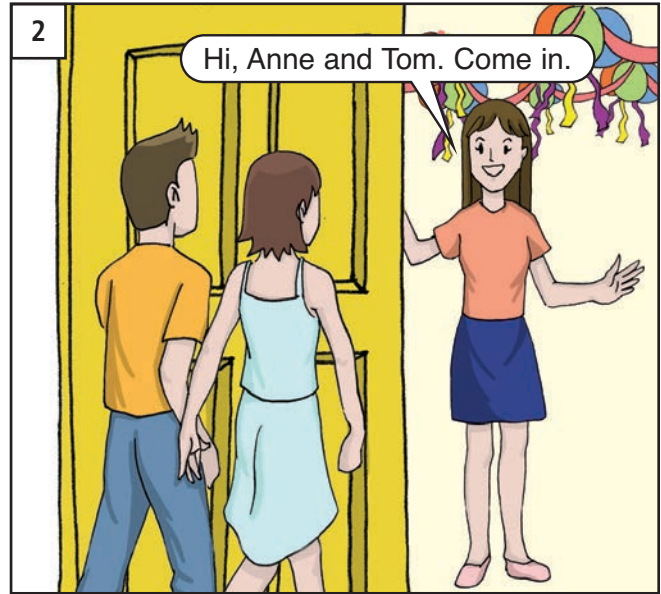

UNIT 4: It's a beautiful day, isn't it?

not [nɑ:t]

aren't [ɑ:rnt]

doesn't [dʌz'nt]

don't [dɒnt]

isn't [iz'ənt]

does [dʌz]

do [du:]

fit [fit]

looks good [luks gud]

runs [rʌnz]

play [plei]

work [wɜ:rk]

sit [sit]

beautiful [bju:'təfəl]

cold [kould]

cute [kju:t]

fast [fæst]

good [gud]

great [greit]

hot [hɑ:t]

wet [wet]

well [wel]

lovely [lʌv'li:]

baby [beɪ'bi:]

day [deɪ]

shoes [ʃu:z]

view [vju:]

plane [pleɪn]

seat [si:t]

mine [maɪn]

yours [jɜ:rs]

It's all right. [ɪts ɔ:l raɪt]

 **you are =** you're

 **are not =** aren't

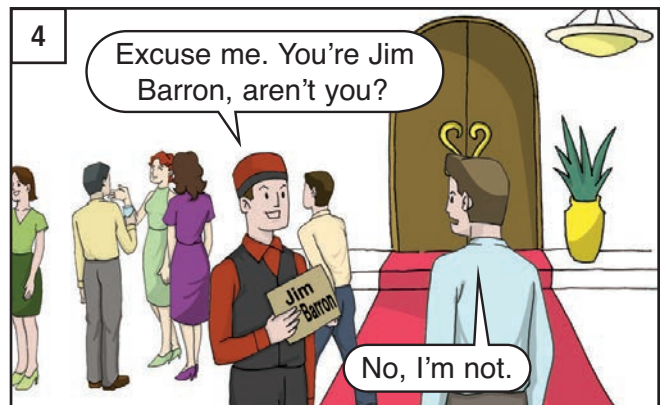
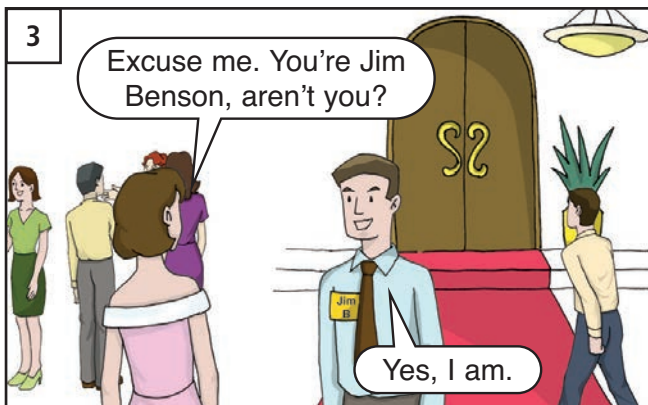
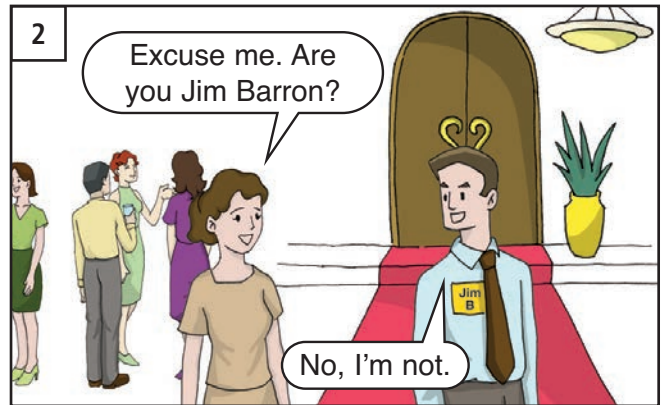
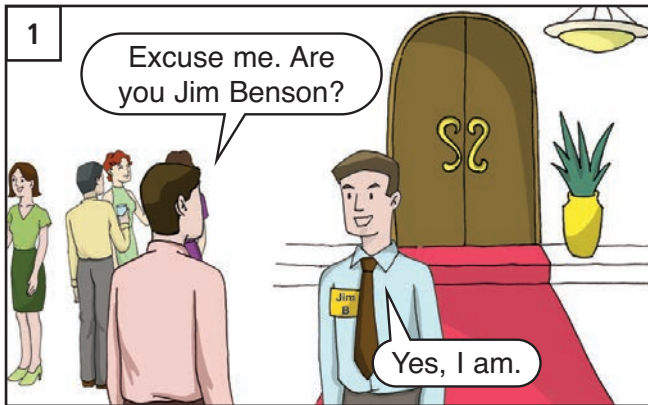



they are = they're

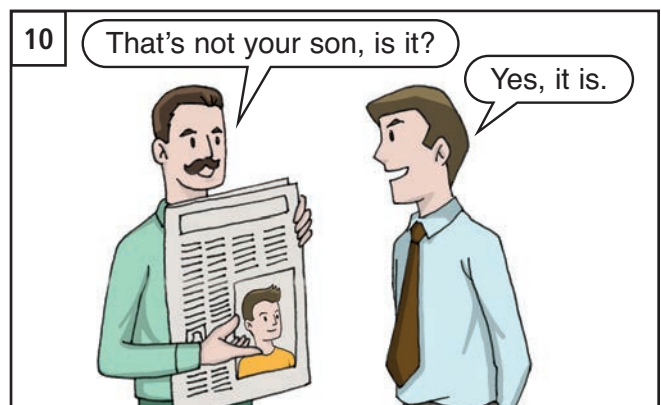
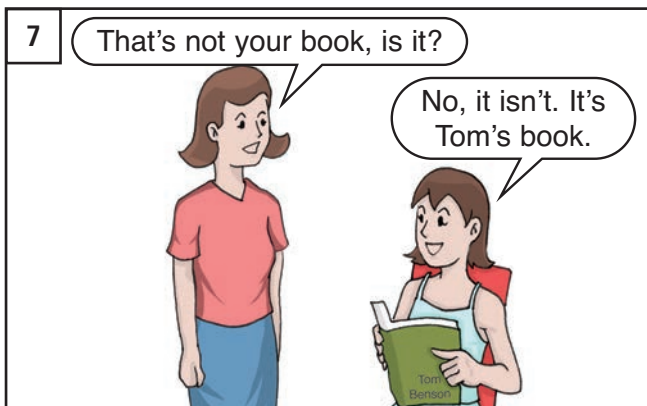
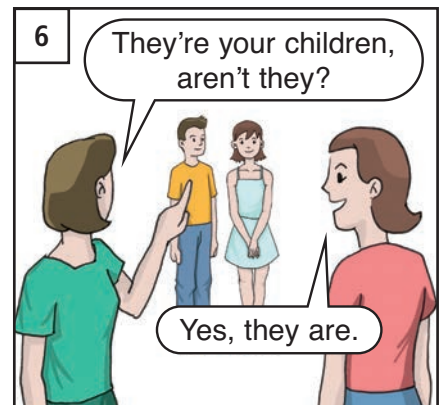
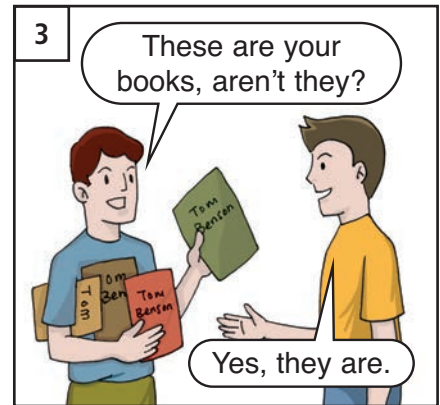
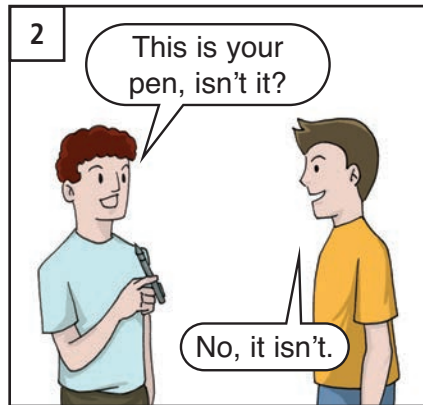
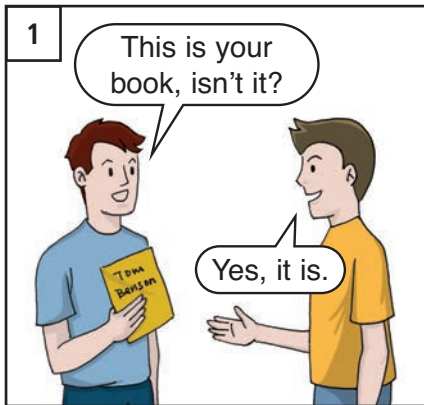

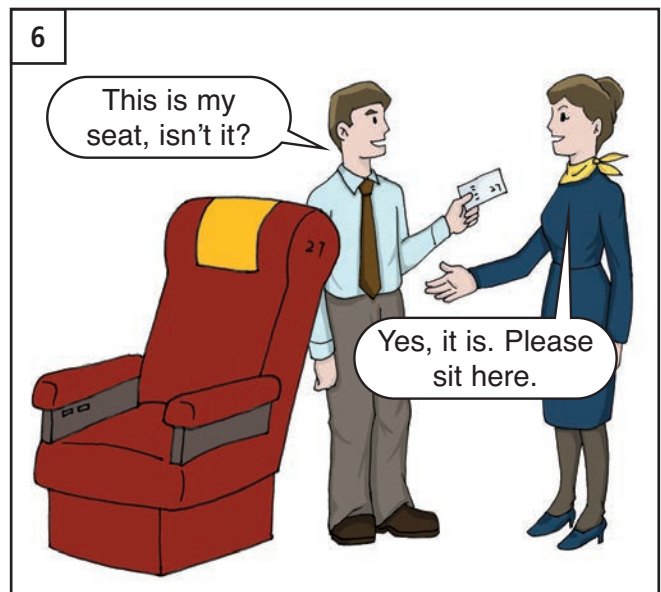
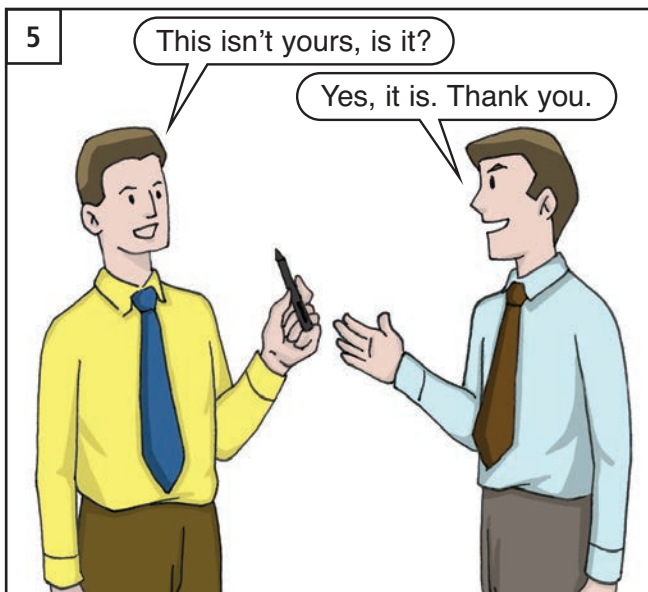
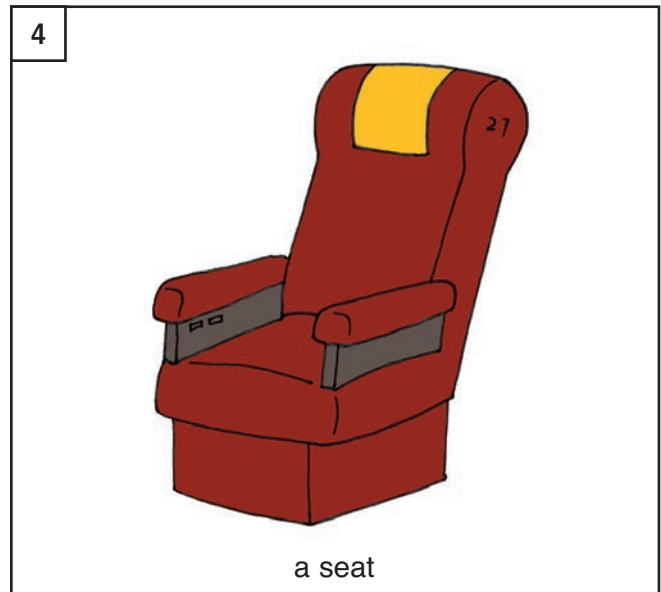
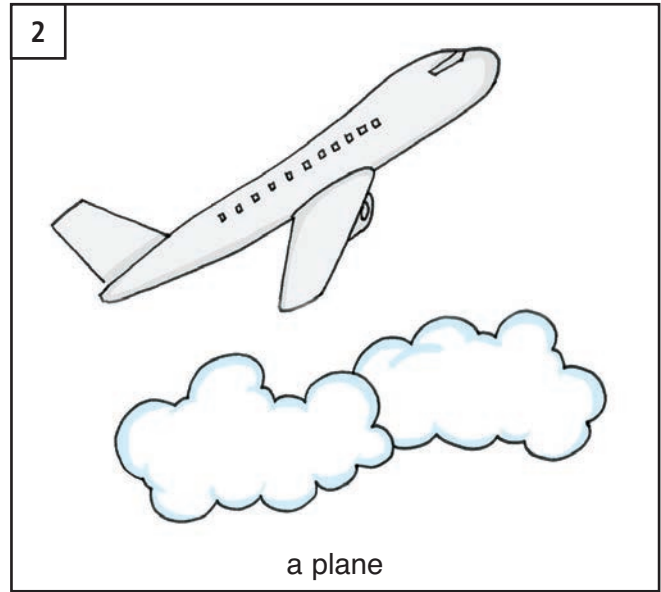

UNIT 4

It's...



a beautiful day...



wet...



hot...



cold...



a great party...

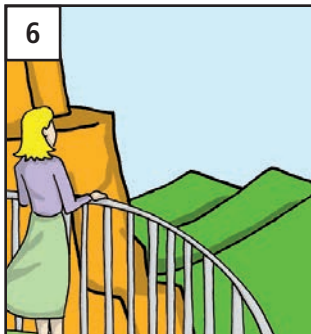

a lovely view...

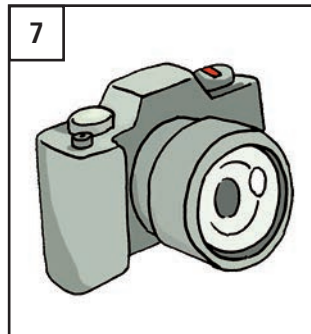

a good camera...



a cute baby...

isn't it?

Yes, it is.

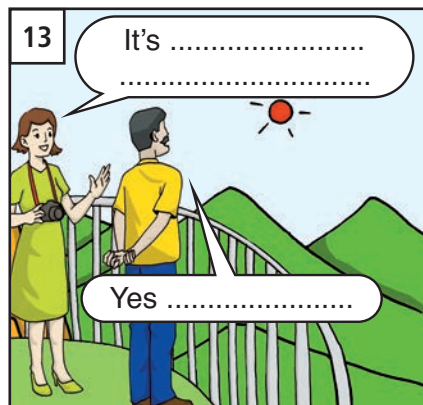
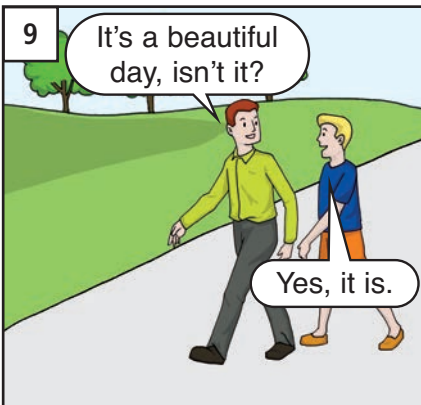

 does not = doesn't.

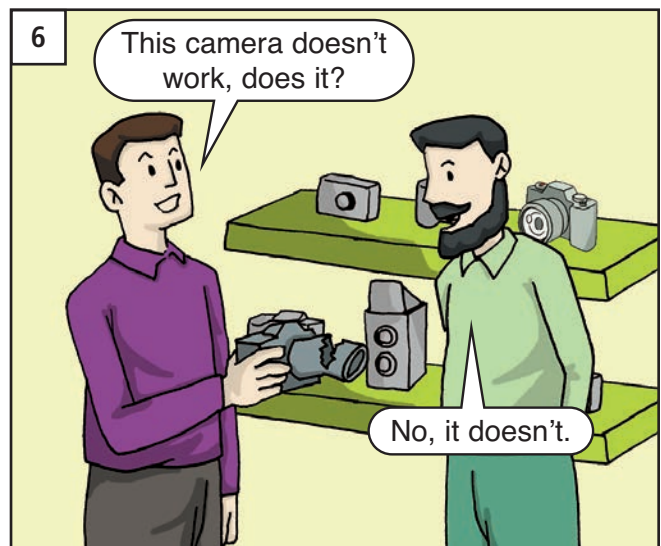
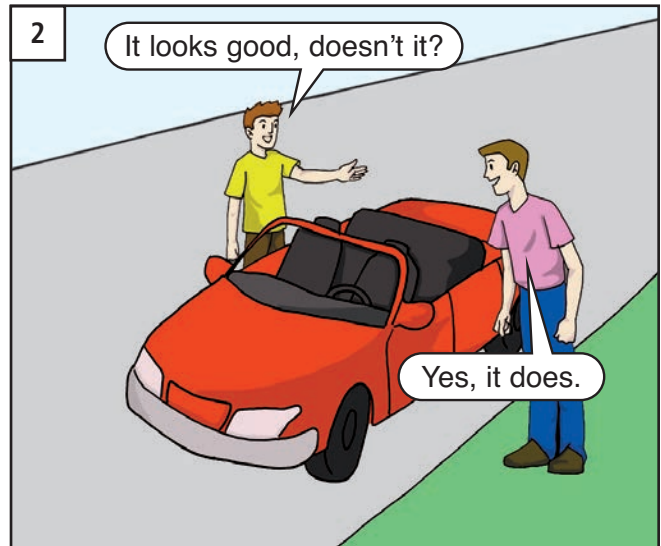

UNIT 4

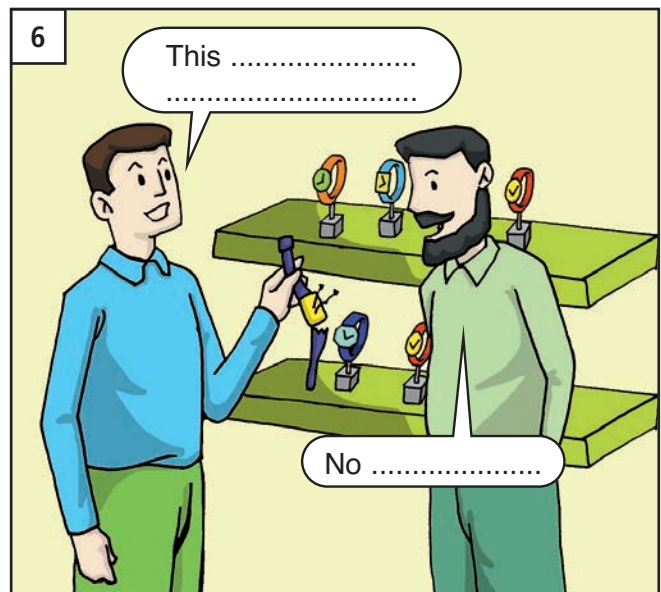
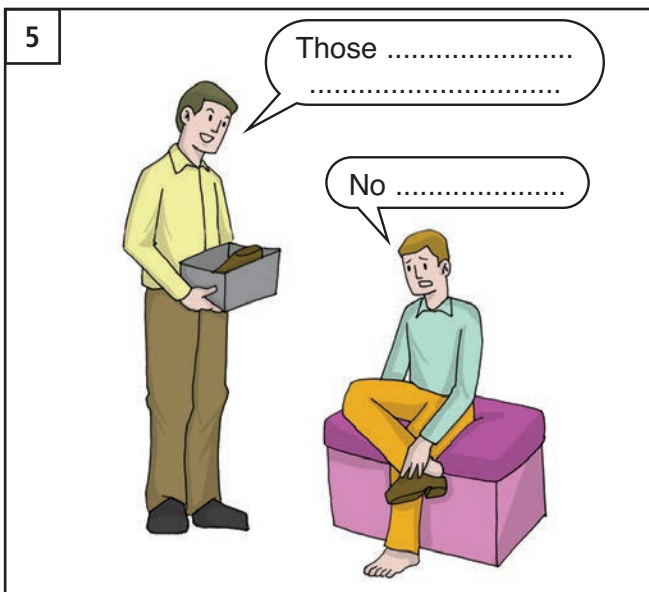
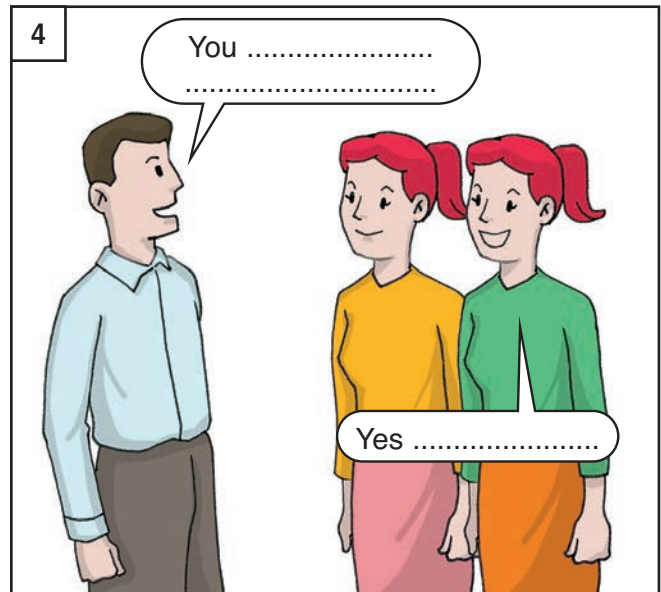
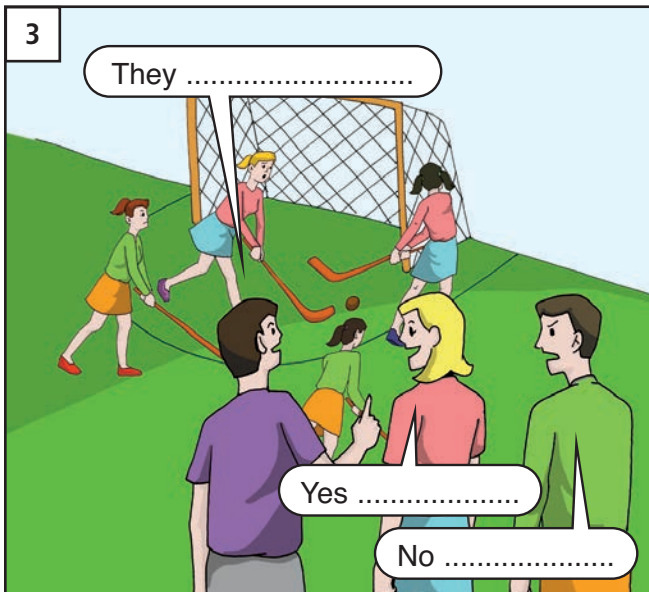
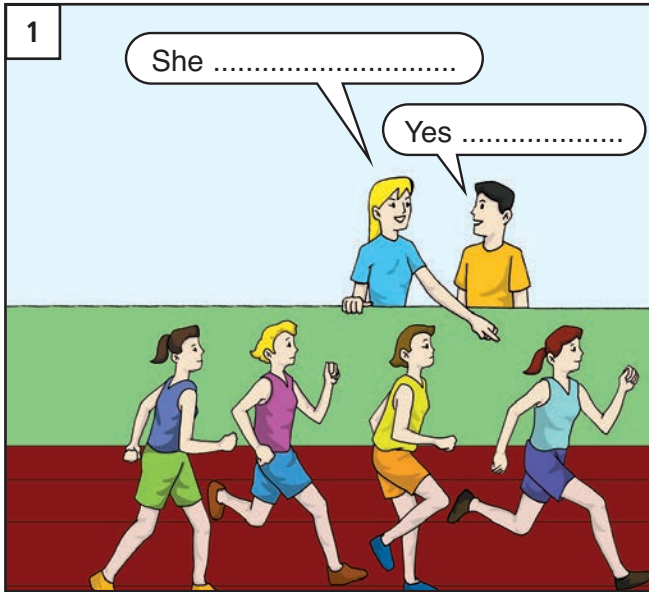



The Bensons





UNIT 5: Revision and extension

1 
 book

2 

3 

4 

5 

6 

7 

8 

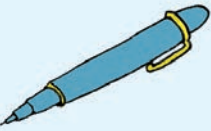
9 

10 

11 

12 

13 

14 

15 

16 

17 

18 

19 

20 

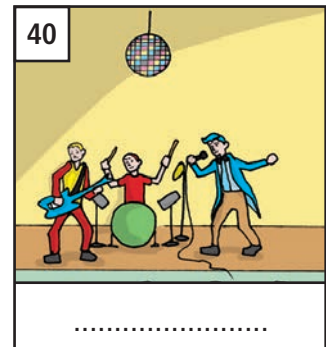
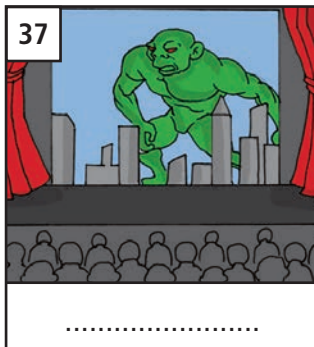
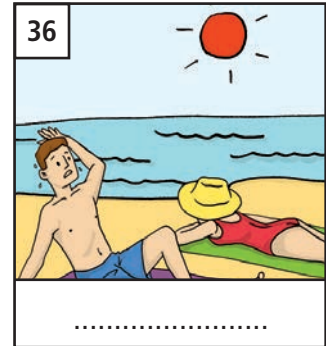
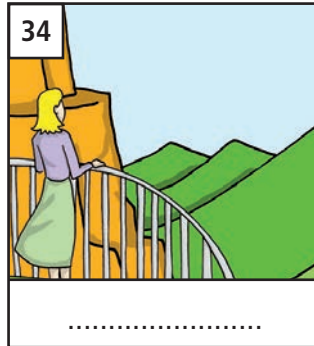
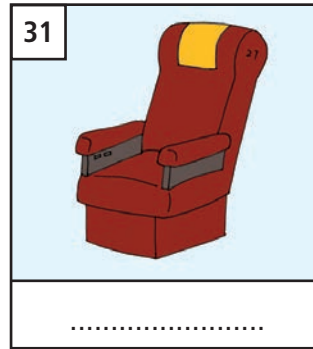
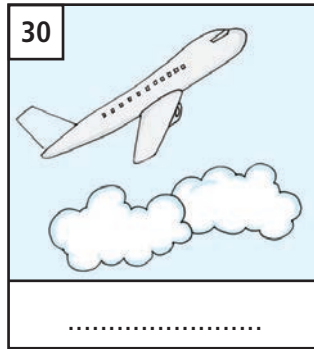
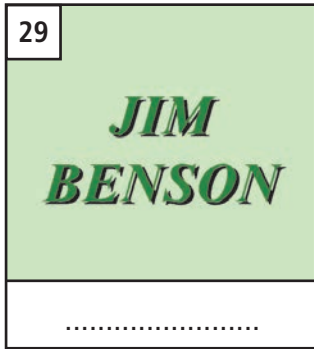
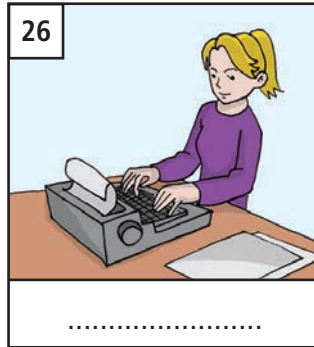
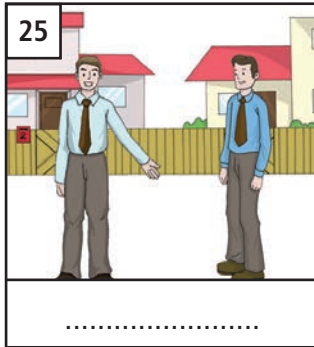
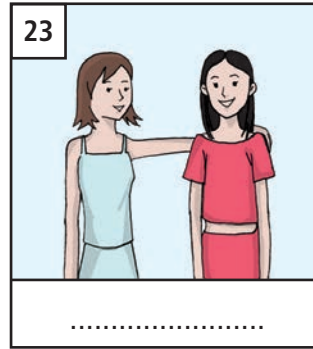

UNIT 5

A

- | | |
|--|----------------------|
| 1. What's your name? | a. That's OK. |
| 2. Whose book is this? | b. Good to meet you. |
| 3. Would you like to come to my party? | c. Tom. |
| 4. Thank you. | d. It's her book. |
| 5. Where's my book? | e. Here. |
| 6. This is my brother Kim. | f. Yes, I'd love to. |

B

- | | |
|---------------------------------------|-------------------|
| 1. Are you Jim Benson? | a. Yes, he is. |
| 2. Is your name Jim Benson? | b. Yes, she is. |
| 3. These are your books, aren't they? | c. Yes, it is. |
| 4. He is your father, isn't he? | d. Yes, they are. |
| 5. She is your sister, isn't she? | e. Yes, I am. |

C

- | | |
|---|--------------------|
| 1. He runs fast, doesn't he? | a. Yes, he does. |
| 2. This camera doesn't work, does it? | b. No, they don't. |
| 3. These shoes don't fit, do they? | c. Yes, I do. |
| 4. You look like your brother, don't you? | d. No, it doesn't. |

this

Come

isn't

mine

his

isn't it

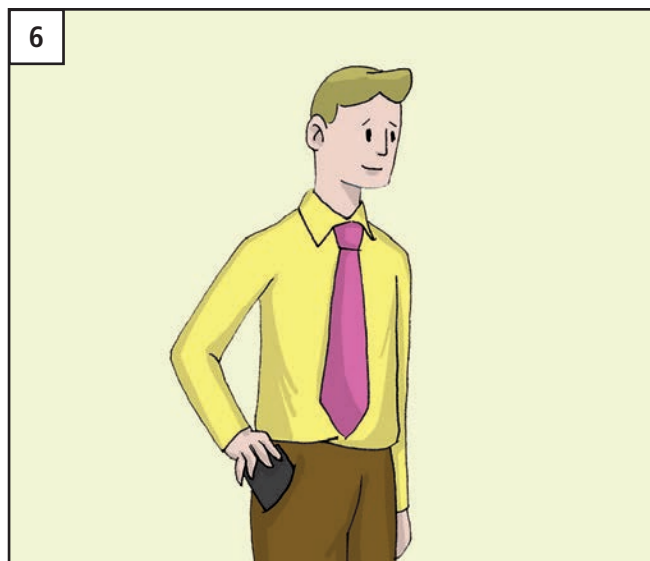

UNIT 5

yours

your

it's

mine

it isn't

Whose

this

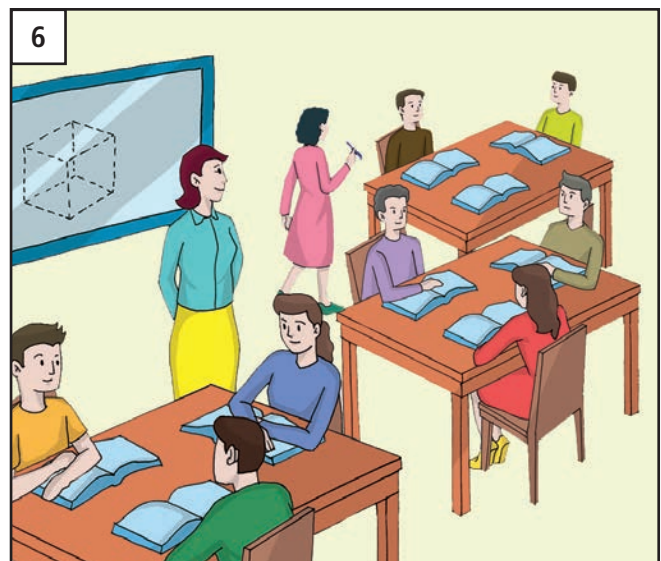
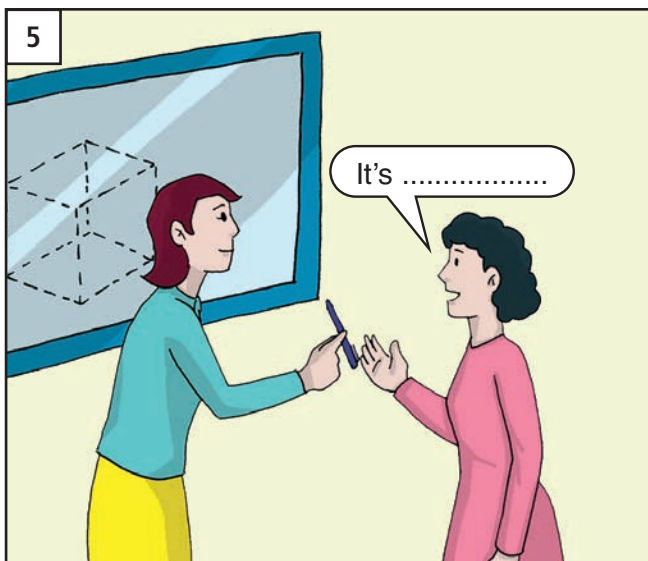
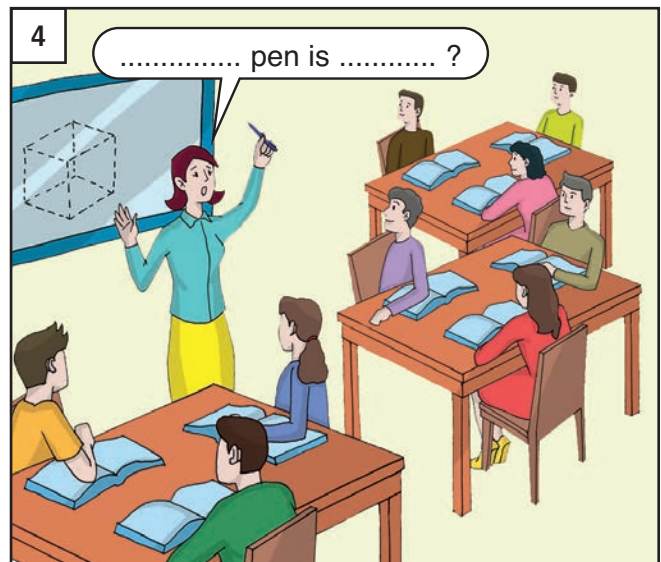
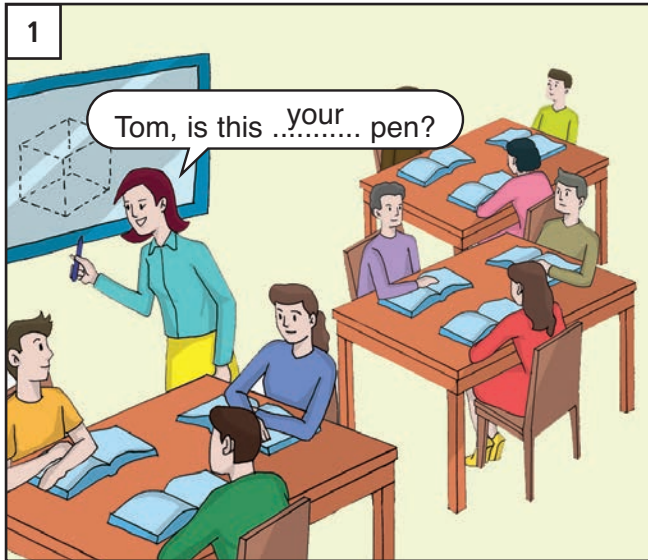

it is

your

like to

meet

My

isn't it

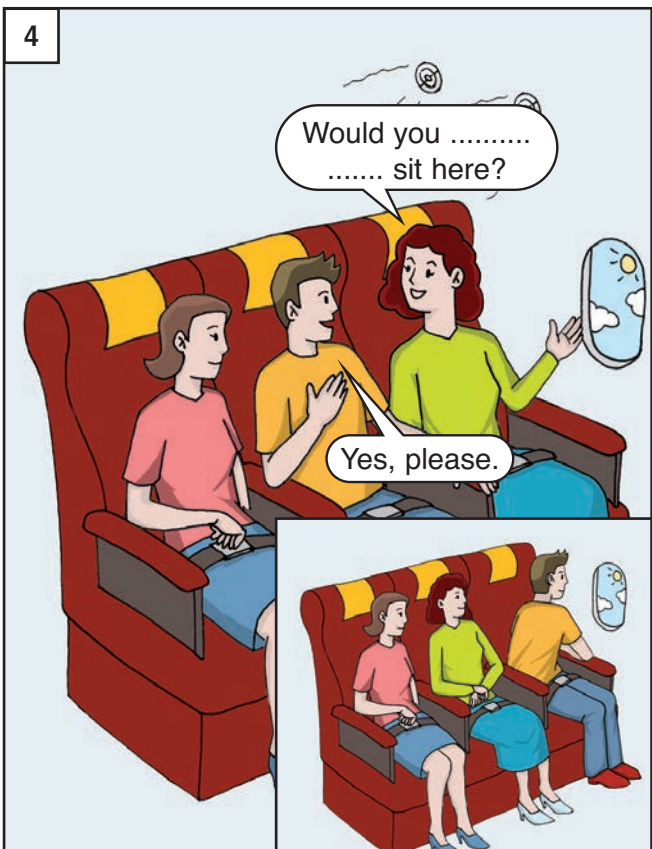
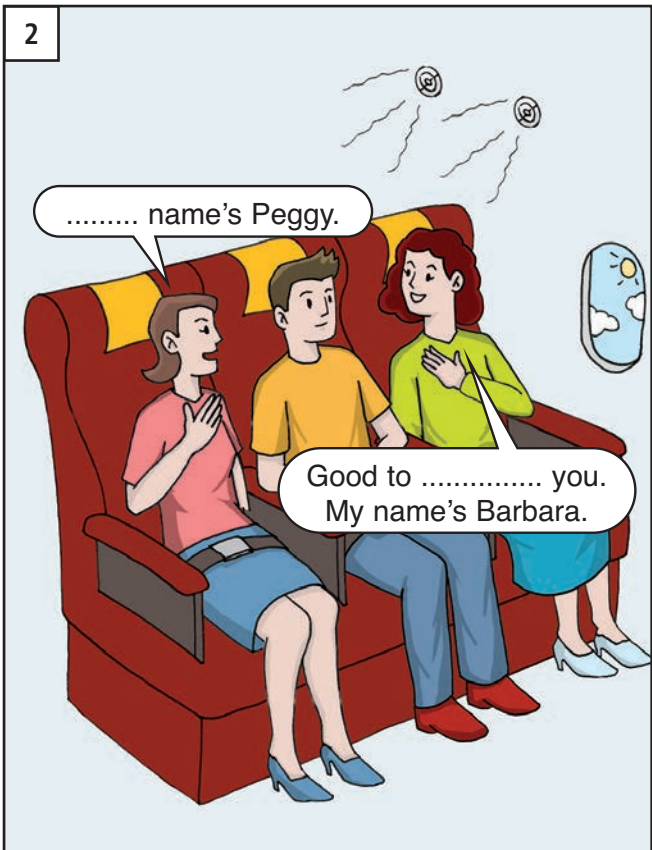

UNIT 5

Yes

about

can't

I am

Good

haven't

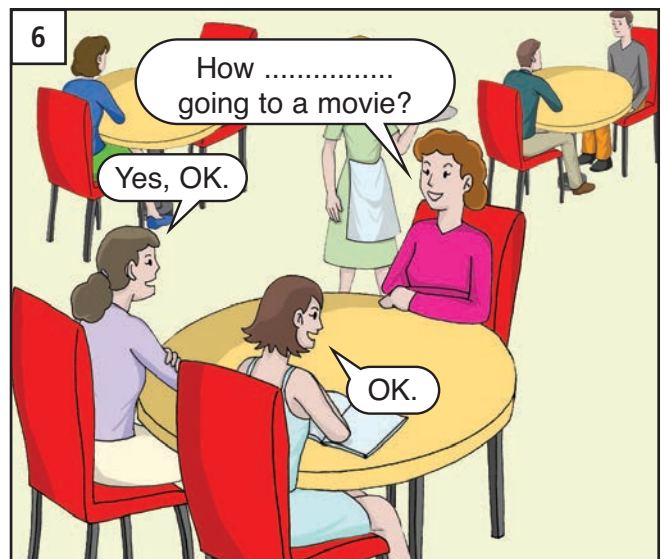
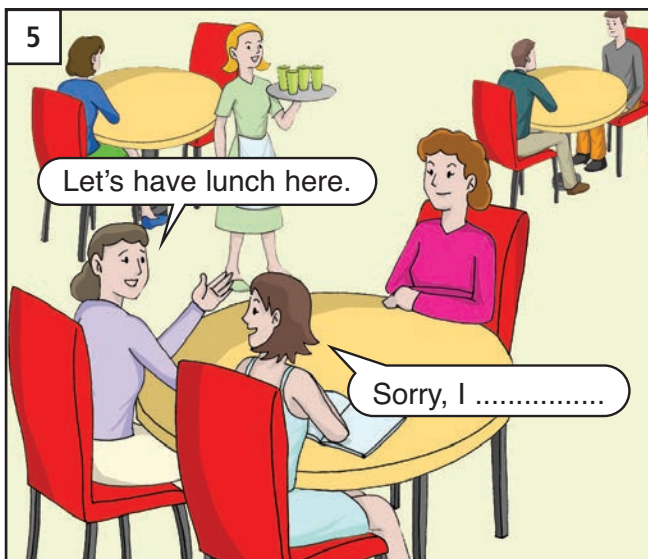
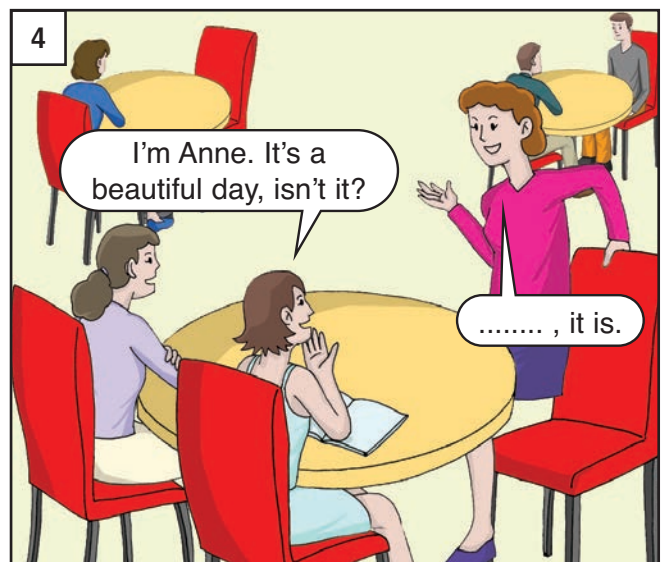
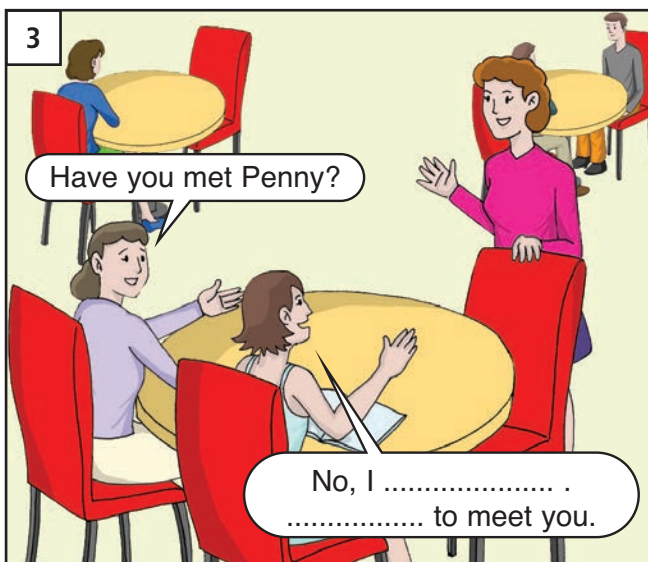

Revision and extension

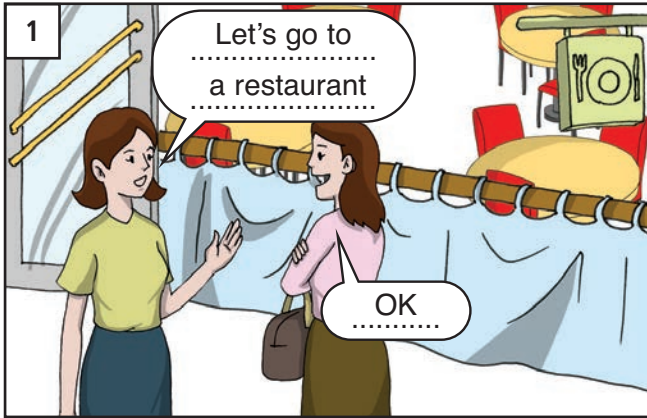

- restaurant go a Let's to
- OK

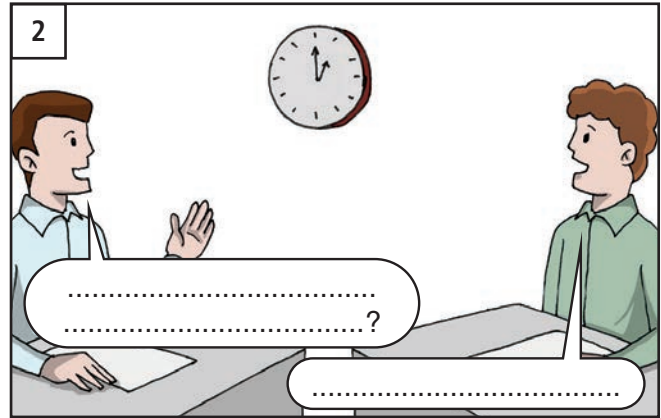

- come like to you Would to lunch
- can't afraid I'm I Sorry

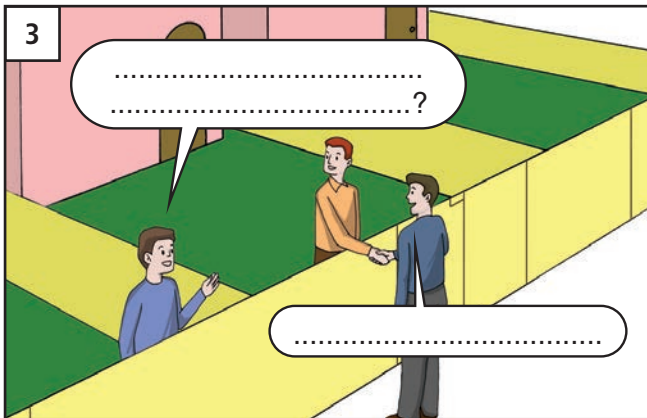

- met neighbor you my Have
- haven't No I



- meet to Jane like I'd you
- meet you to Good

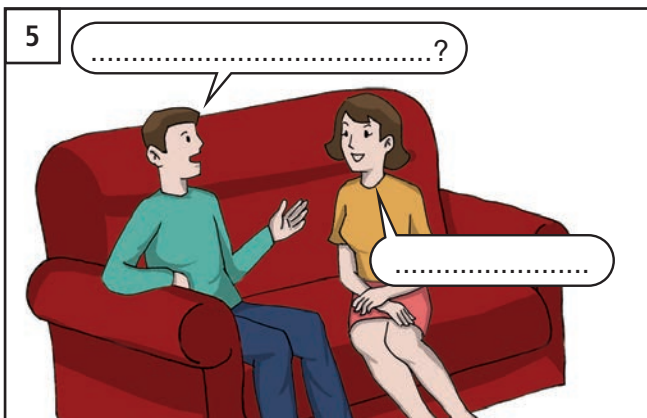

- movie to going about How a
- great be That'd



- going You're to the meeting aren't you
- I'm No not

UNIT 5

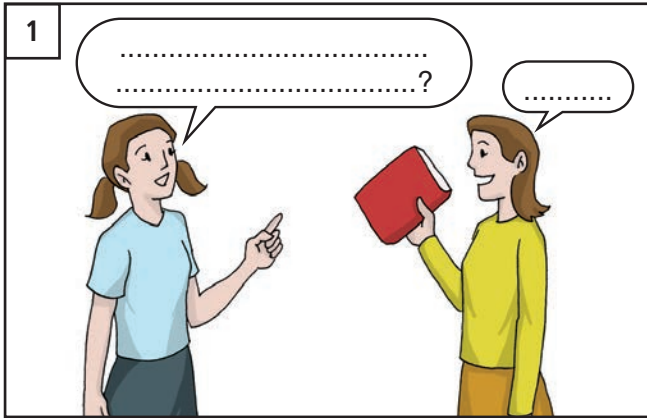

- > book It's interesting an isn't it
- > it Yes is

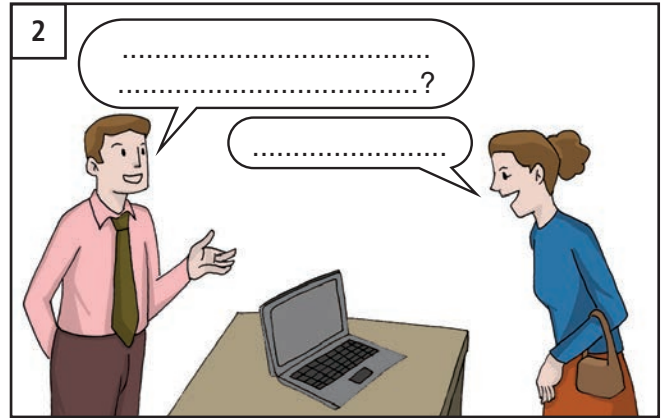

- > good This looks laptop doesn't it
- > does Yes it



- > pen my That's isn't it
- > isn't No it



- > are keys yours These aren't they
- > Yes are they



- > here work You don't you
- > No I don't

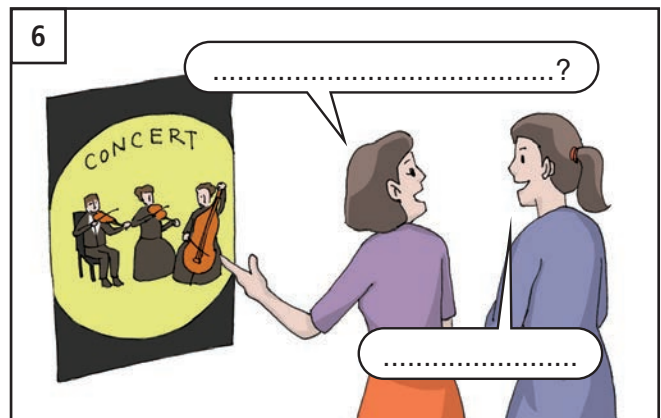

- > concerts like You don't you
- > do I Yes

UNIT 5: Answers

Unit 5, page 38

- | | | | | |
|-----------|-------------|-----------------|------------|----------------|
| 1. book | 2. camera | 3. car | 4. family | 5. watch |
| 6. house | 7. laptop | 8. mobile phone | 9. pen | 10. purse |
| 11. beach | 12. key | 13. art gallery | 14. dinner | 15. market |
| 16. lunch | 17. meeting | 18. theater | 19. party | 20. restaurant |

Unit 5, page 39

- | | | | | |
|----------------|---------------|------------|-------------|--------------|
| 21. accountant | 22. colleague | 23. friend | 24. manager | 25. neighbor |
| 26. secretary | 27. teacher | 28. baby | 29. name | 30. plane |
| 31. seat | 32. cold | 33. shoes | 34. view | 35. wet |
| 36. hot | 37. movies | 38. door | 39. wallet | 40. concert |

Unit 5, page 40

- A. 1c 2d 3f 4a 5e 6b B. 1e 2c 3d 4a 5b C. 1a 2d 3b 4c

Unit 5, page 41

1. this, isn't 2. his 3. Come 4. isn't it 5. mine

Unit 5, page 42

1. your 2. it's 3. yours? it isn't 4. Whose, this 5. mine

Unit 5, page 43

1. isn't it, it is 2. My, meet 3. your 4. like to

Unit 5, page 44

2. I am 3. haven't, Good 4. Yes 5. can't 6. about

Unit 5, page 45

- Let's go to a restaurant.
OK.
- Would you like to come to lunch?
Sorry, I'm afraid I can't.
- Have you met my neighbor?
No, I haven't.
- I'd like you to meet Jane.
Good to meet you.
- How about going to a movie?
That'd be great.
- You're going to the meeting, aren't you?
No, I'm not.

Unit 5, page 46

- It's an interesting book, isn't it?
Yes, it is.
- This laptop looks good, doesn't it?
Yes, it does.
- That's my pen, isn't it?
No, it isn't.
- These keys are yours, aren't they?
Yes, they are.
- You work here, don't you?
No, I don't.
- You like concerts, don't you?
Yes, I do.

UNIT 6: Would you like something to drink?

Would you like...? [wʊd ju: laɪk]

What would you like? [wɑ:t wʊd ju: laɪk]

No, thanks. [nəʊ θæŋks]

Yes, please. [jes pli:z]

...would be nice. [wʊd bi: naɪs]

something to eat [sʌm'θɪŋ tu: i:t]

piece of... [pi:s ʌv]

something to drink [sʌm'θɪŋ tu: driŋk]

cup of... [kʌp ʌv]

glass of... [glæs ʌv]

can of... [kæn ʌv]

bottle of... [bɑ:t'əl ʌv]

cookie [kʊk'i:]

chips [tʃɪps]

sausage [sɔ:'sɪdʒ]

nuts [nʌts]

cake [keɪk]

sandwich [sænd'wɪtʃ]

burger [bɜ:r'gɜ:r]

juice [dʒu:s]

milk [mɪlk]

water [wɔ:'tɜ:r]

tea [ti:]

coffee [kɔ:f'i:]

sugar [ʃʊg'ə:r]

apple [æp'əl]

banana [bənæn'ə]

peach [pi:tʃ]

orange [ɔ:r'ɪndʒ]

plum [plʌm]

pear [pe:r]

How many... ? [hou meni:]

one [wʌn]

two [tu:]

three [θri:]

four [fɔ:r]

five [faɪv]

six [sɪks]

seven [sev'ən]

eight [eɪt]

nine [naɪn]

ten [ten]

bag [bæg]

child [tʃaɪld]

tablet [tæb'let]

ticket [tɪk'ət]

sock [sɔ:k]

a pair of [ə pe:r ʌv]

some [sʌm]

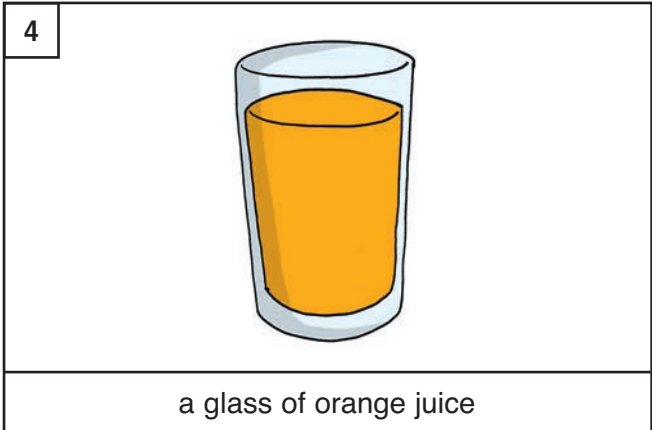
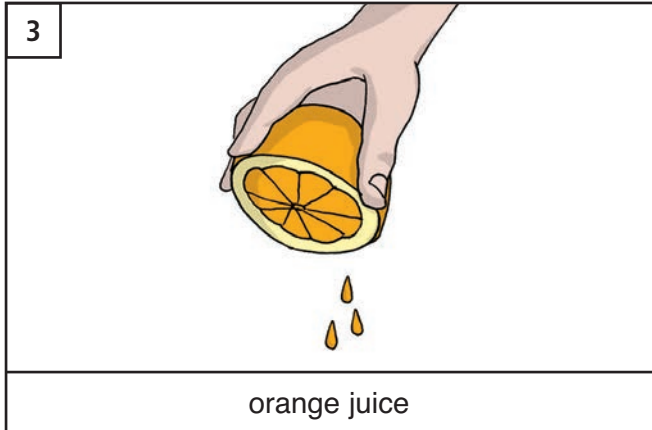
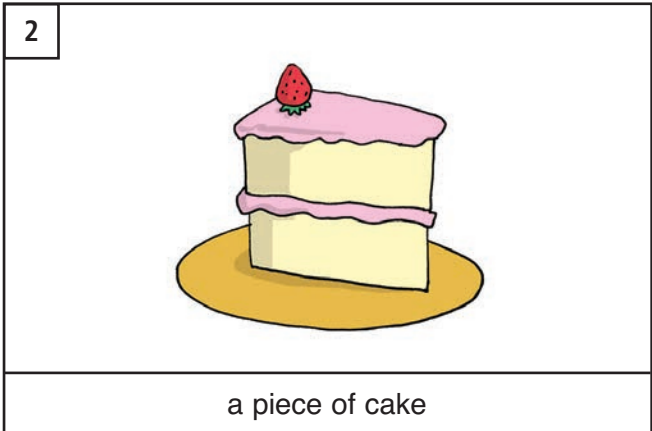
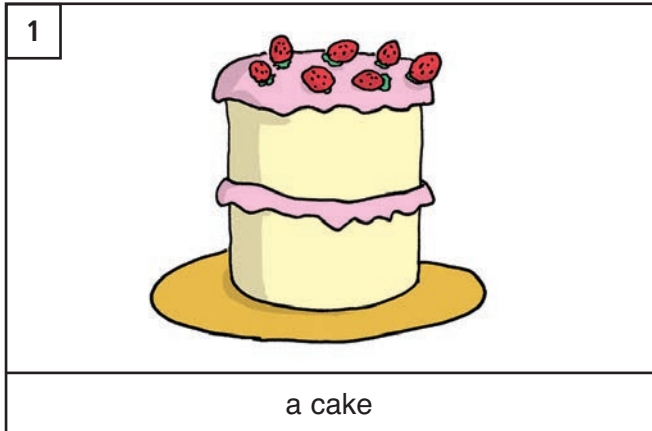

UNIT 6

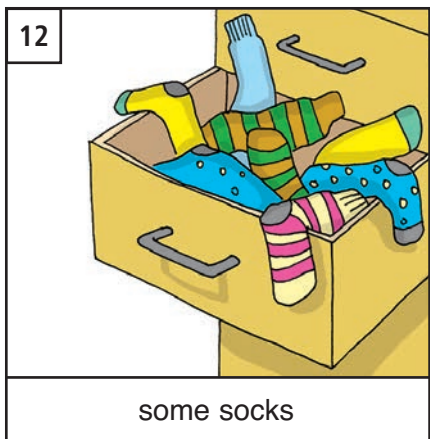
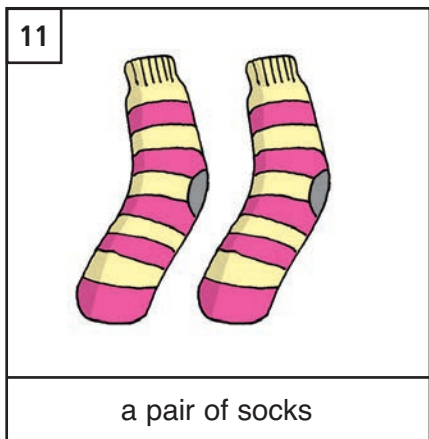
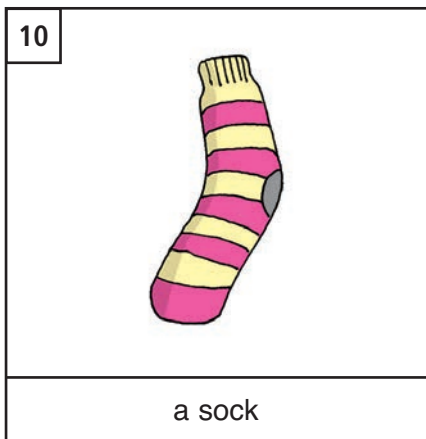
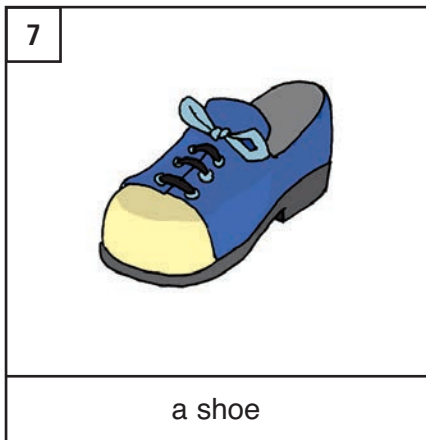
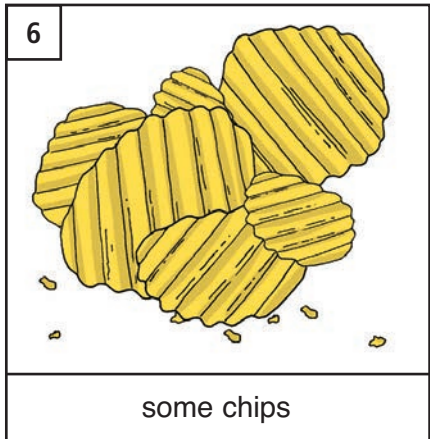
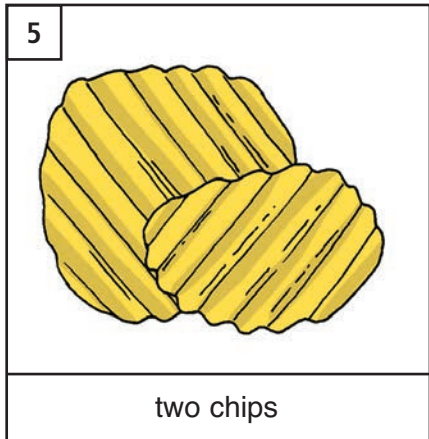
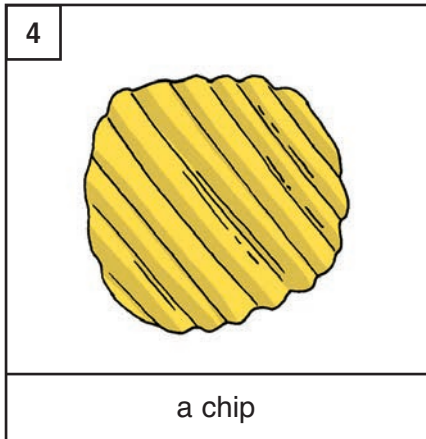
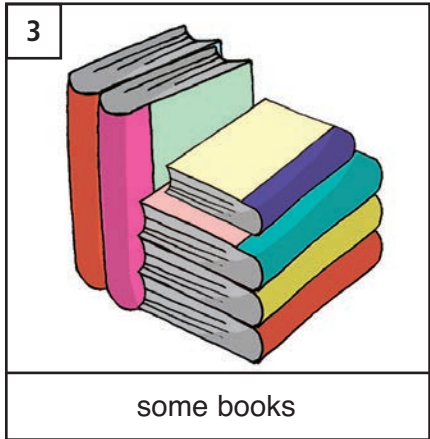
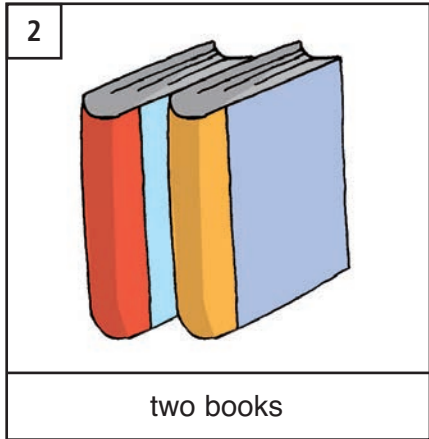
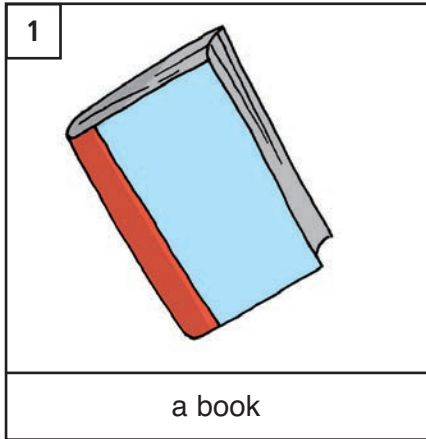

Would you like something to drink?



Would you like...?

1

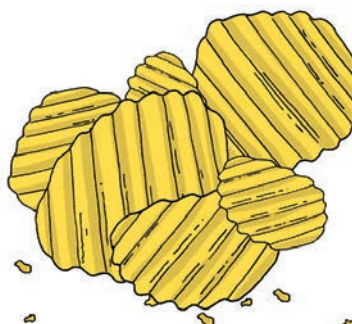

some chips

2



some nuts

3

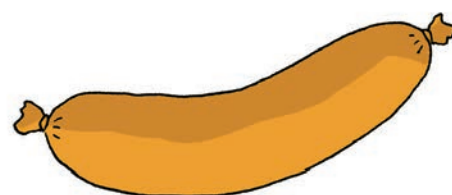

a sausage

4



a cookie

5

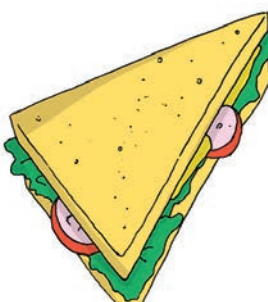

a sandwich

6

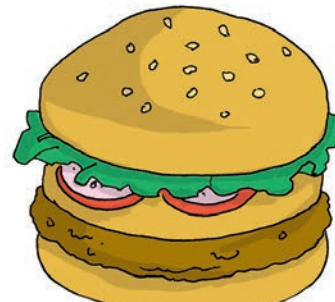

a burger

something to eat

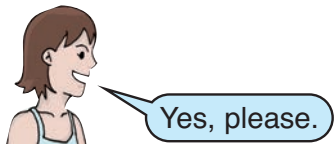

UNIT 6

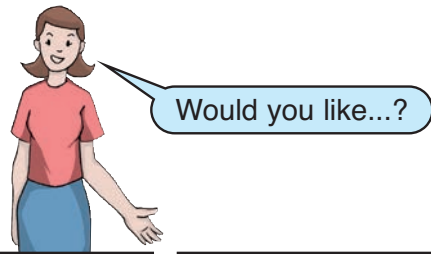

1



an apple

2



an orange

3

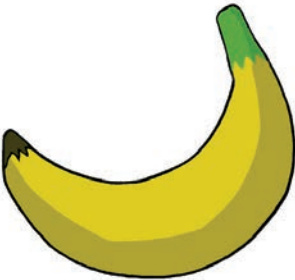

a banana

4

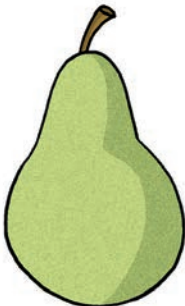

a pear

5

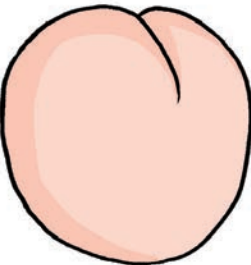

a peach

6

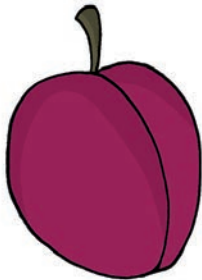

a plum

something to eat

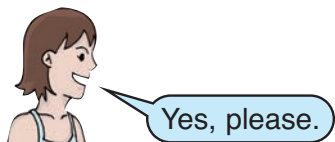

Would you like something to drink?



Would you like...?

1



a can of Fizzo

2



a bottle of orange juice

3



a glass of water

4



a glass of milk

5



a cup of tea

6



a cup of coffee

something to drink



Yes, please.



No, thanks.

UNIT 6

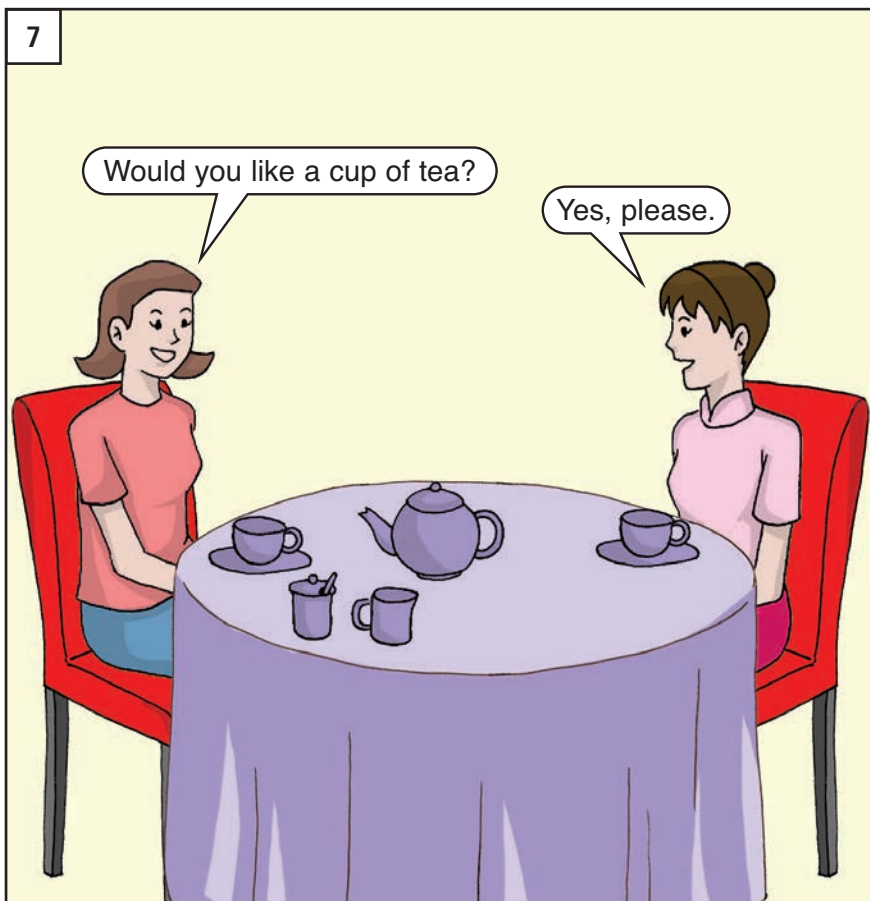
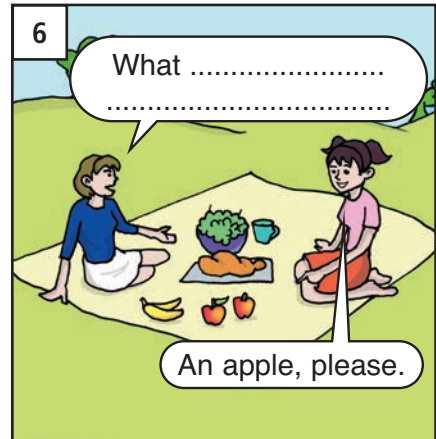
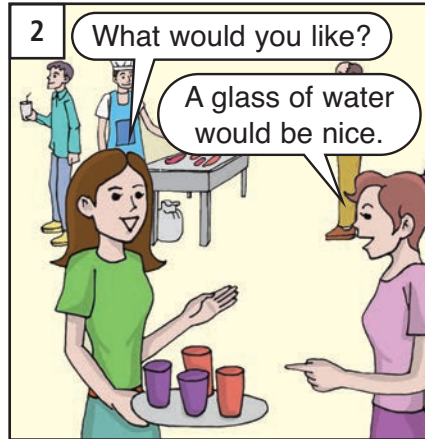

Would you like something to drink?

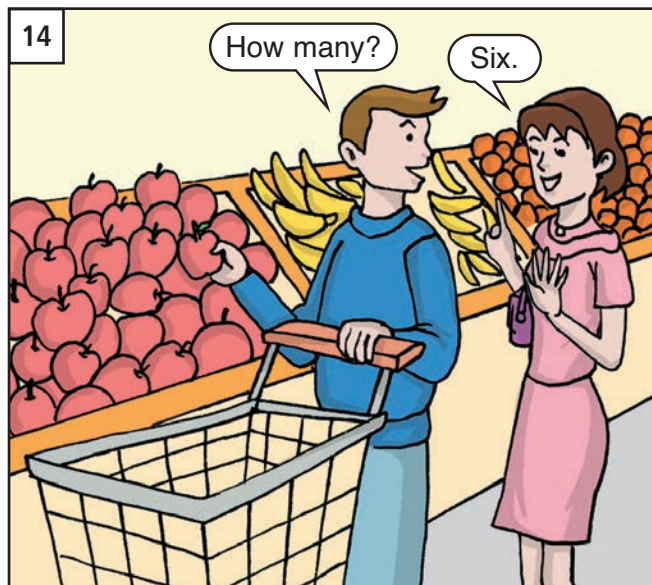
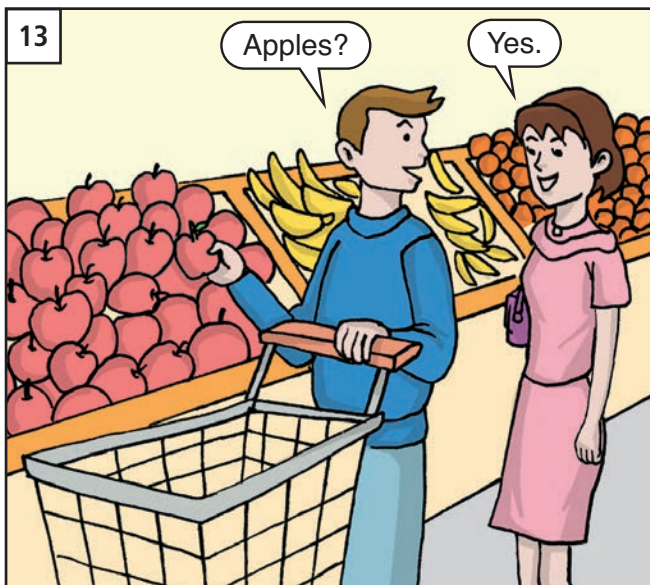
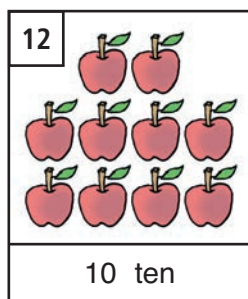
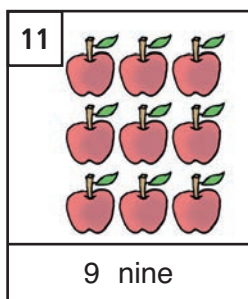
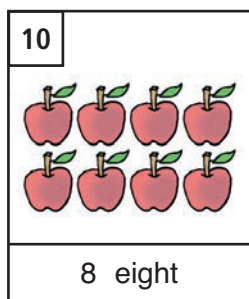
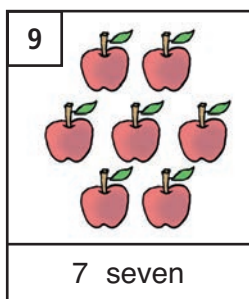
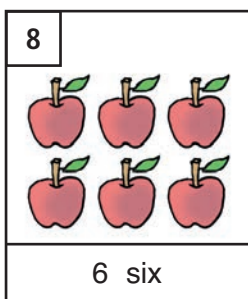
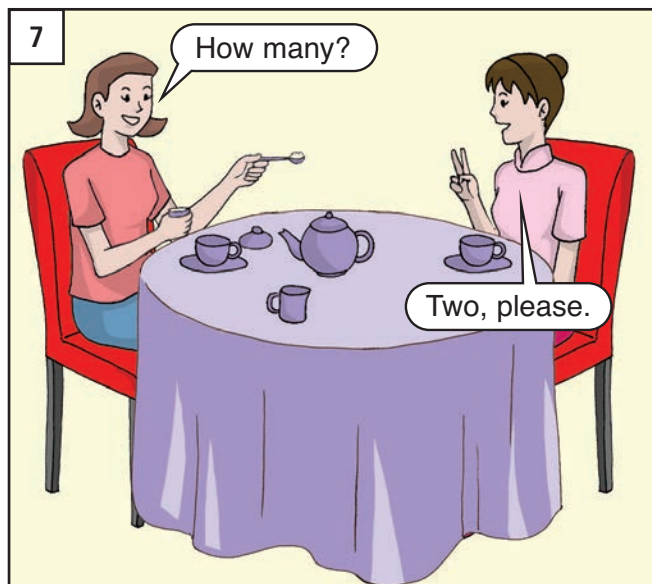
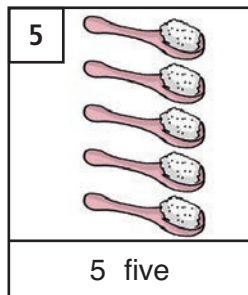
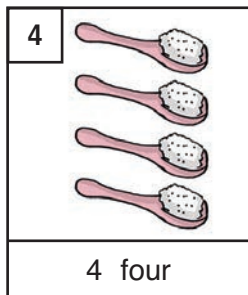
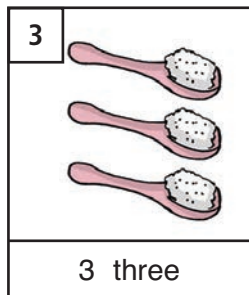
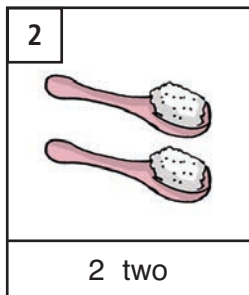
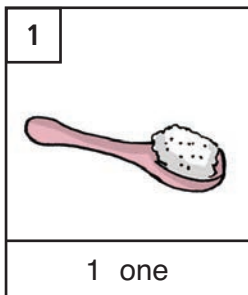

UNIT 6

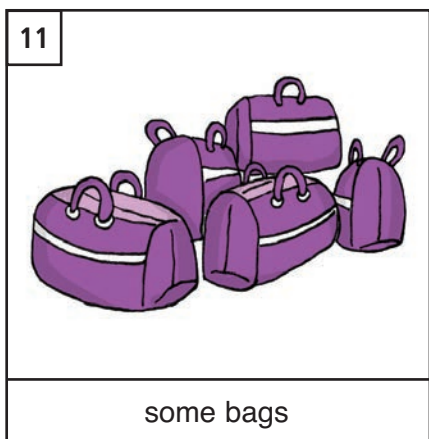
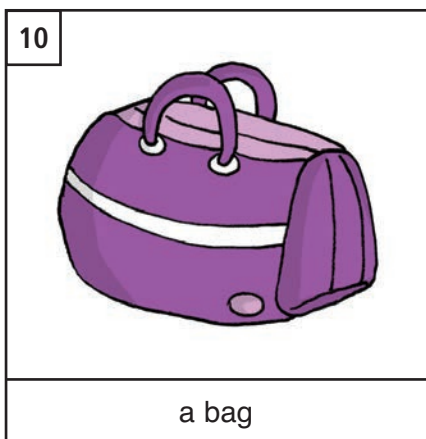
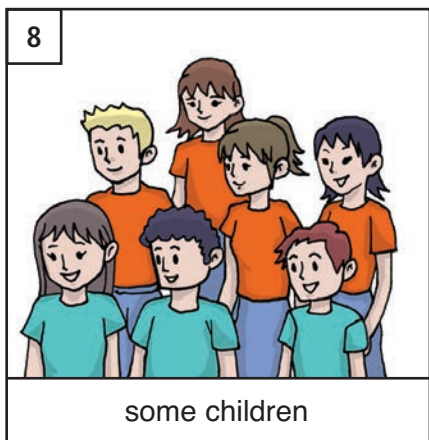
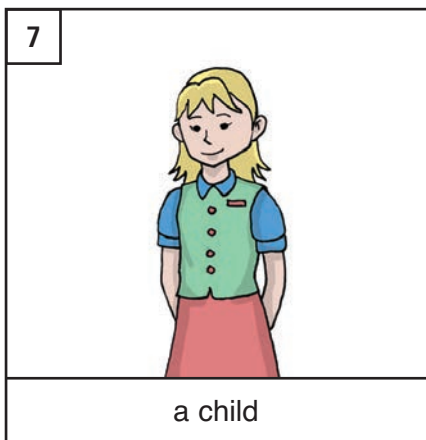
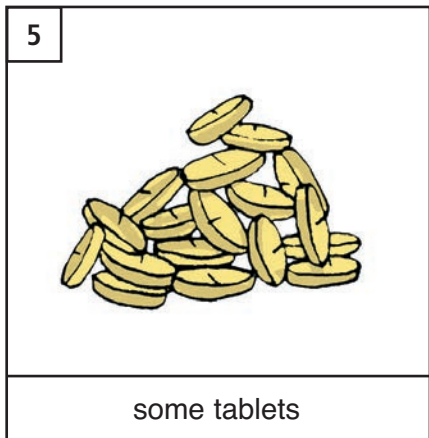
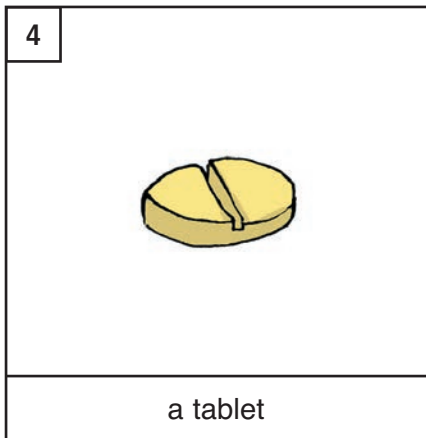
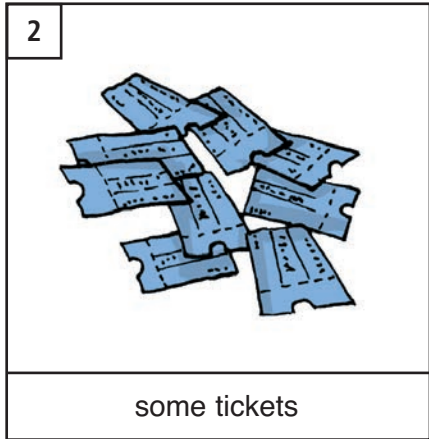
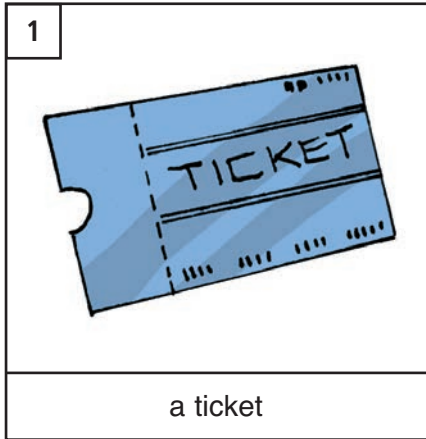

The Bensons



UNIT 7: He's a tour guide.

application form [æplikei'fən fɔ:rm]

occupation [a:kjəpeɪ'ʃən]

now [naʊ]

too [tu:]

from [frʌm]

to [tu:]

businessman [biz'nismæn]

pharmacist [fɑ:r'məsɪst]

doctor [dɑ:k'tɔ:r]

nurse [nɜ:rs]

mechanic [mækæ'nɪk]

police officer [pəli:s'ɔ:fɪsə:r]

receptionist [risep'ʃənɪst]

sales assistant [seɪlz əsɪs'tənt]

taxi driver [tæk'si: drai'vɔ:r]

tour guide [tu:r gaɪd]

hello [heləʊ]

hi [haɪ]

What do you do? [wʌt du: ju: du:]

I'm a ... [aɪm ə]

did [dɪd]

was [wʌz]

were [wɜ:r]

when [wen]

have [hæv]

How many ... do you have?

[haʊ men'i: du: ju: hæv]

Could you repeat that, please?

[kʊd ju: rɪpi:t' ðæt pli:z]

I'm sorry. [aɪm sɑ:r'i:]

slowly [sləʊli:]

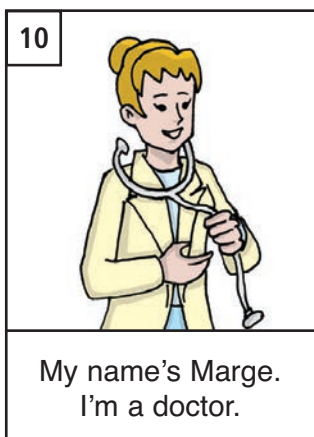
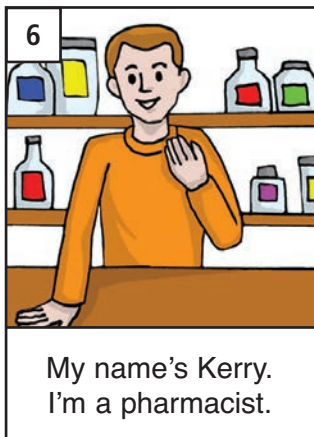
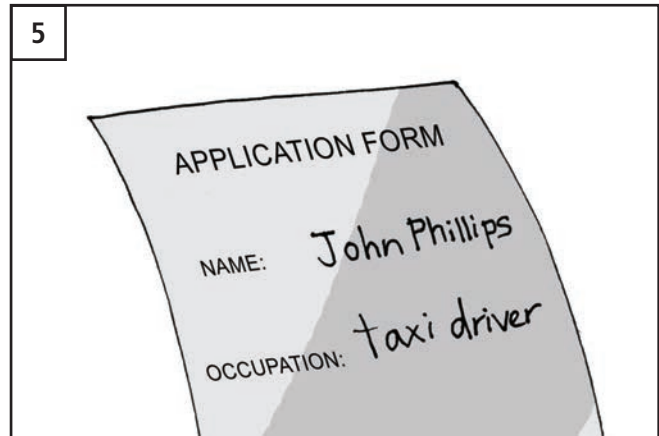

UNIT 7

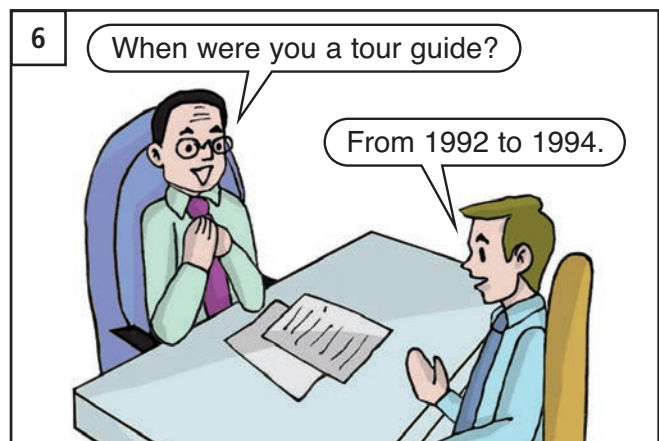
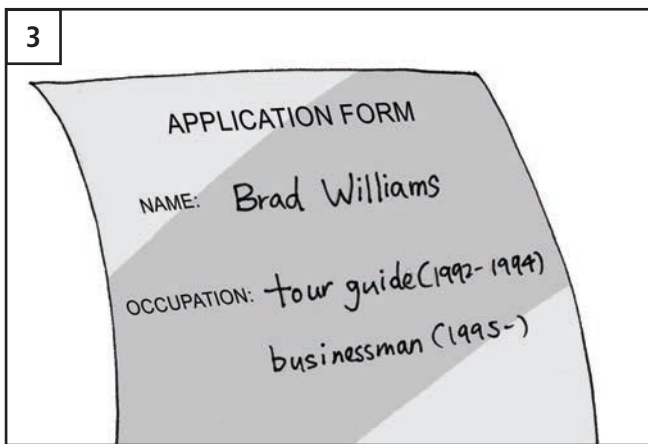

He's a tour guide.

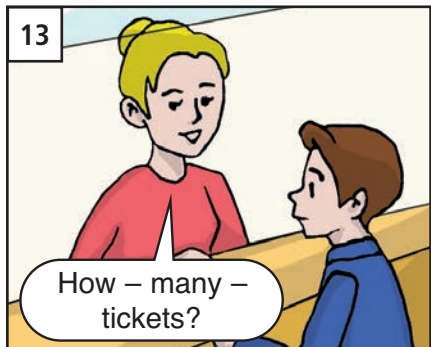
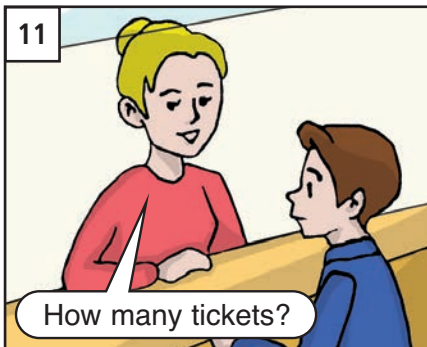
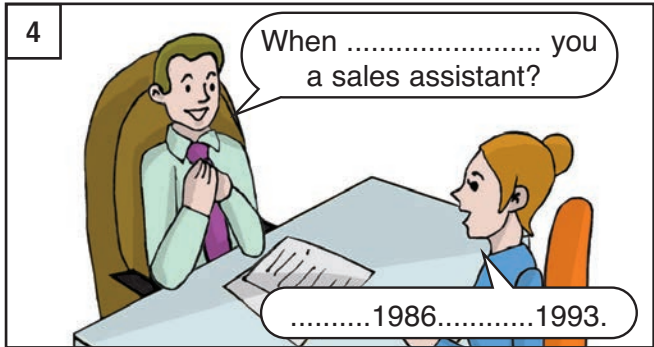
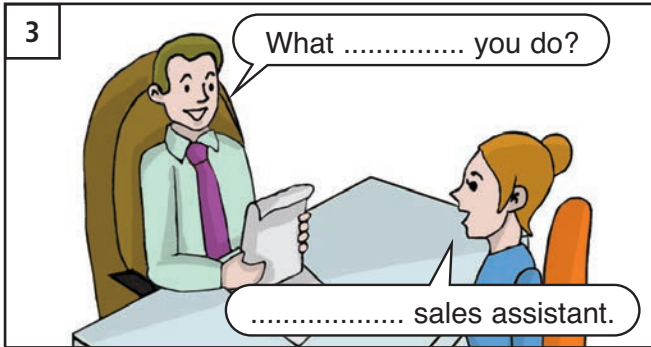
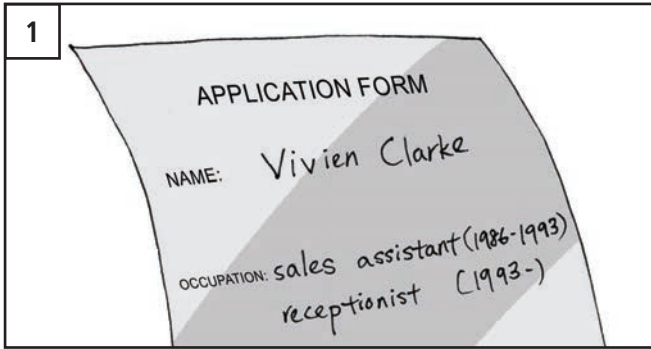

The Bensons

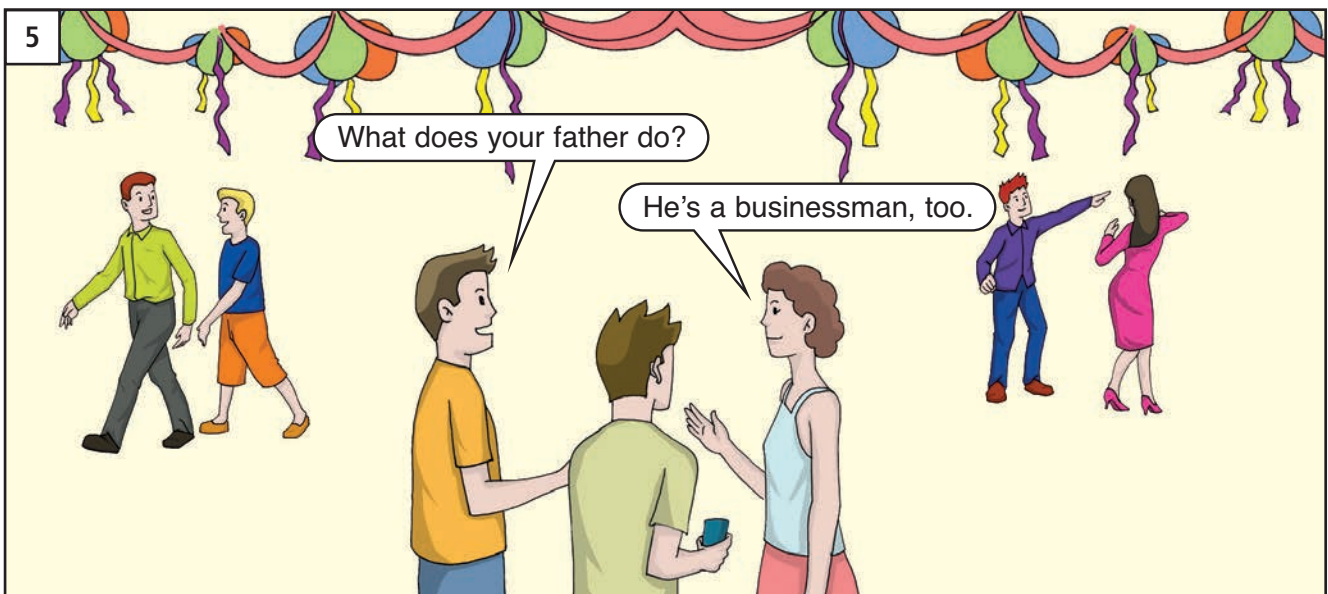
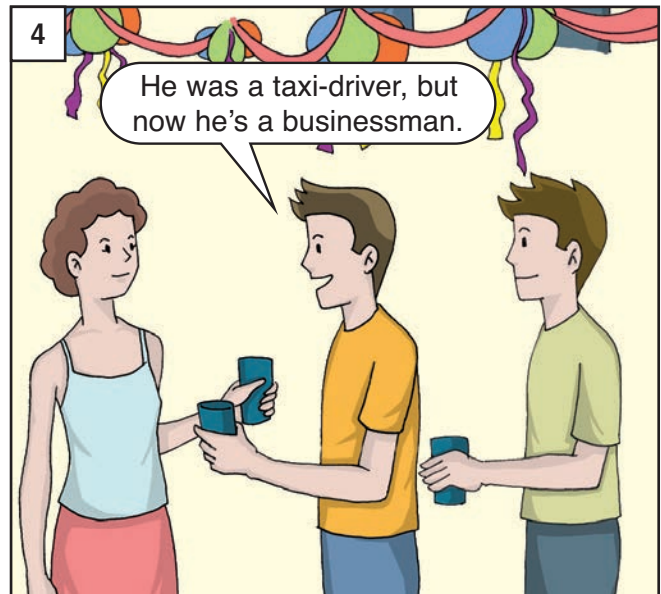
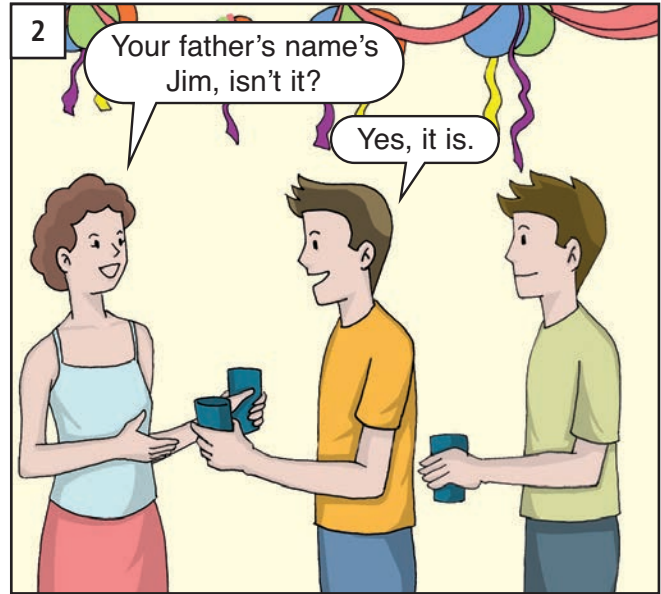



here is = here's

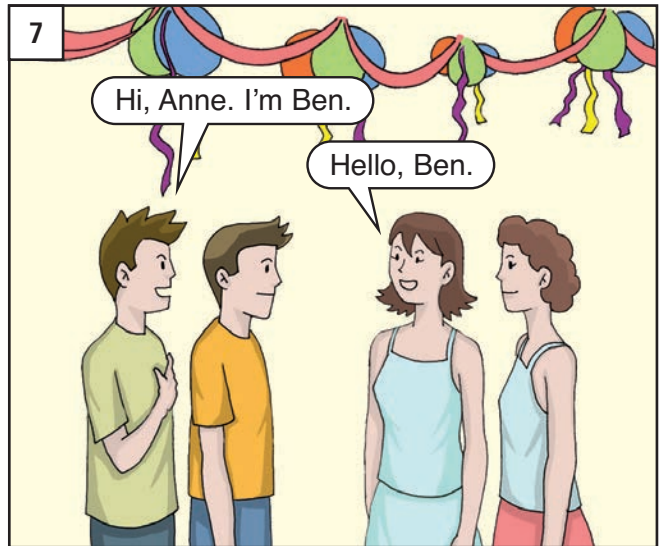
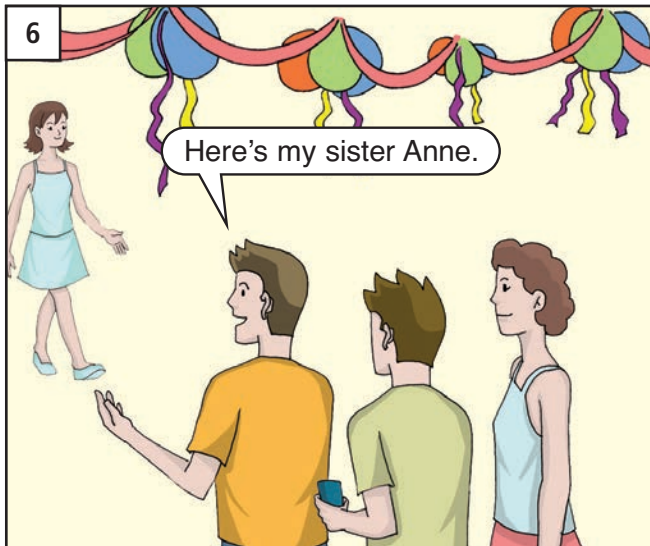

UNIT 8: I'm going to New York.

How did you get here?

[hau dɪd ju: get hi:r]

How long have you been here?

[hau lɔ:ŋ hæv ju: bin hi:r]

I'm from... [aɪm frʌm]

I've been here for... [aɪv bin hi:r fɔ:r]

Where are you from? [we:r a:r ju: frʌm]

arrive [əraɪv]

leave [li:v]

January [dʒæn'ju:weəri:]

February [feb'jəweəri:]

March [ma:rtʃ]

April [eɪp'rəl]

May [meɪ]

June [dʒu:n]

July [dʒʌlaɪ']

August [ɔ:g'əst]

September [septem'bɜ:r]

October [a:ktəʊ'bɜ:r]

November [nouvem'bɜ:r]

December [disem'bɜ:r]

eleven [ɪlev'ən]

twelve [twelv]

thirteen [θə:r'ti:n]

fourteen [fɔ:r'ti:n]

fifteen [fɪf'ti:n]

sixteen [sɪks'ti:n]

seventeen [sev'ənti:n]

eighteen [eɪ'ti:n]

nineteen [naɪn'ti:n]

twenty [twen'ti:]

everyone [ev'ri:wʌn]

Monday [mʌn'deɪ]

Tuesday [tu:z'deɪ]

Wednesday [wenz'deɪ]

Thursday [θə:rz'deɪ]

Friday [fraɪ'deɪ]

Saturday [sæt'ə:deɪ]

Sunday [sʌn'deɪ]

month [mʌnθ]

week [wi:k]

weekend [wi:k'end]

year [ji:r]

day [deɪ]

How much... ? [hau mʌtʃ]

dollars [da:l'ɜ:rz]

cents [sents]

school [sku:l]

by [baɪ]

since [sɪns]

for [fɔ:r]

still [stɪl]

bus [bʌs]

plane [pleɪn]

train [treɪn]

1



dollars



cents

2

How much is this pen?



It's eleven dollars.



= \$11

3

How much is this wallet?



It's twelve dollars.



= \$12

4

How much is that book?



It's thirteen dollars.



= \$13

5

How much is that purse?



It's fourteen dollars.



= \$14

6

fifteen dollars



sixteen dollars



seventeen dollars



eighteen dollars



nineteen dollars



twenty dollars



UNIT 8

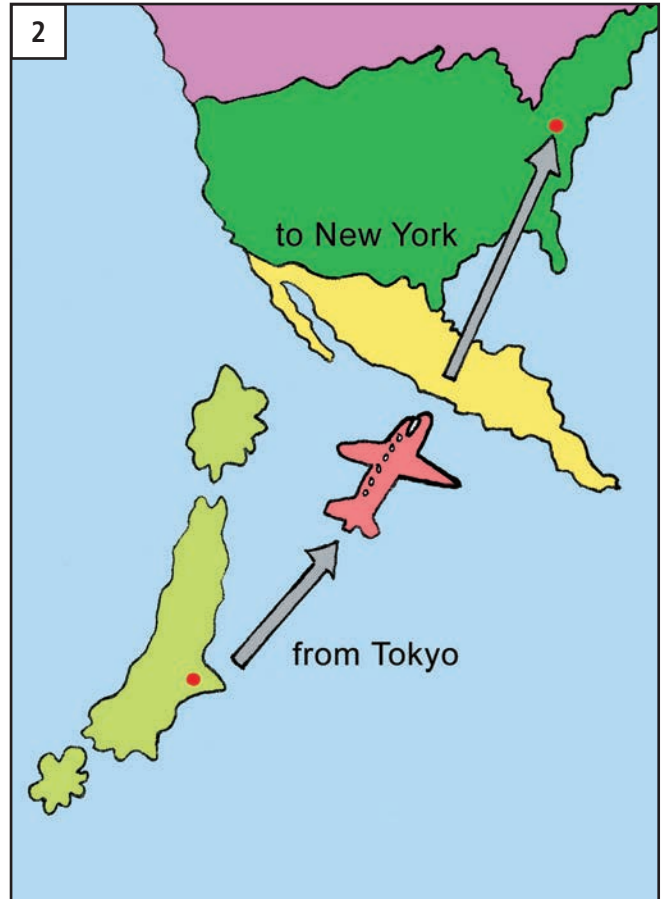

1

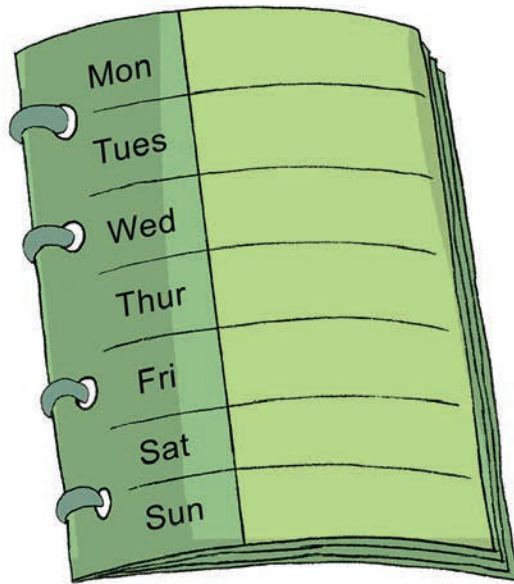

seven days = one week

Mon	Tues	Wed	Thurs	Fri	Sat	Sun
Monday	Tuesday	Wednesday	Thursday	Friday	Saturday	Sunday
					Weekend	

2

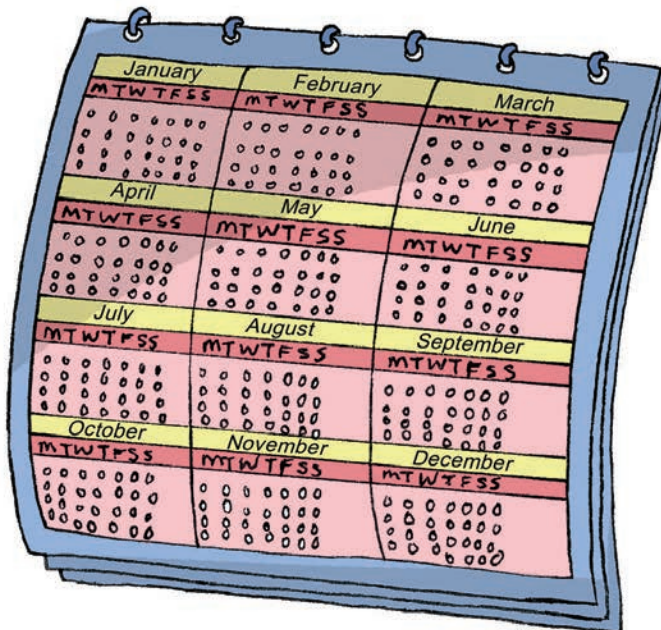

twelve months = one year

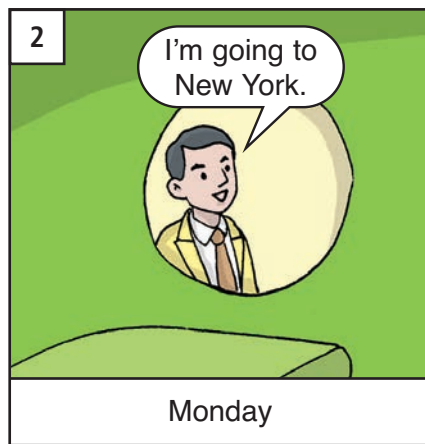
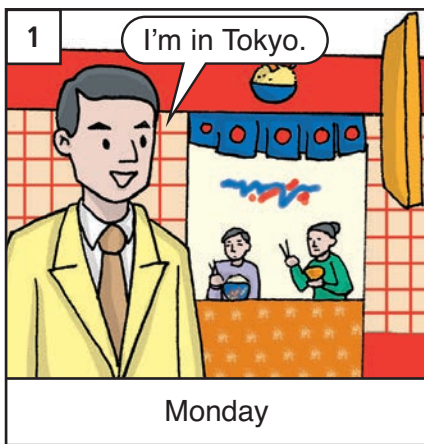
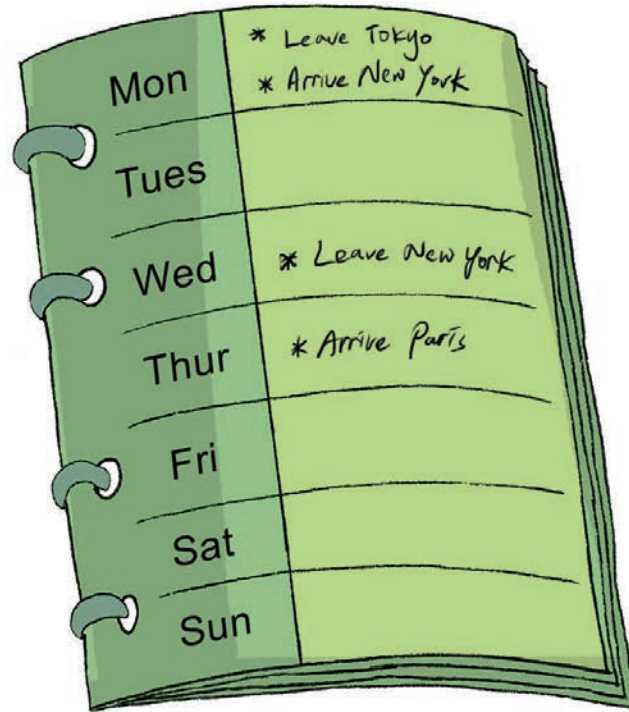

 I have = I've

 we have = we've



1

London Airport

Monday



2

How long have you been here?

I've been here for two days.

Wednesday



3

London Airport

Saturday 4th October



4

How long have you been here?

We've been here for two weeks.

Saturday 18th October



5

London Airport

June 10th



6

How long have you been here?

December 10th

1 Airport



1996, Australia

A man in a brown shirt is loading suitcases onto a wooden pallet. A woman in an orange top is holding a baby, and a young boy in a green shirt stands nearby. A black suitcase and a grey bag are on the pallet.

2



How long have you been in Australia?

For three years.

Since 1996.

1999

A woman in a red top and yellow skirt is talking to a family (mother, daughter, and boy) in front of a school building. The mother is wearing a purple top and orange skirt.

3



How did you get here?

By plane.

A woman in a red top and yellow skirt is talking to a family in front of a school building. The mother is wearing a purple top and orange skirt.

4



August, Sydney

A woman in a pink top and red skirt is walking with a man in a light blue shirt and dark pants. They are both carrying bags.

5



How long have you been in Sydney?

For two months.

Since August.

October

Three people (a woman in a yellow top, a man in a green shirt, and a woman in a green top) are sitting around a round table with a white tablecloth.

6



How did you get here?

By train.

The same three people from the previous panel are sitting at the table.

7



Wednesday, Sydney

A man in a white shirt and brown pants is getting on an orange bus. He is carrying a brown suitcase.

8



How long have you been in Sydney?

.....

.....

.....

Saturday

Three people (a woman in a purple top, a man in a grey shirt, and a woman in a blue dress) are sitting on a green sofa in a room with a desk and a computer monitor.

7



How did you get here?

By bus.

The same three people from the previous panel are sitting on the sofa.

The Bensons

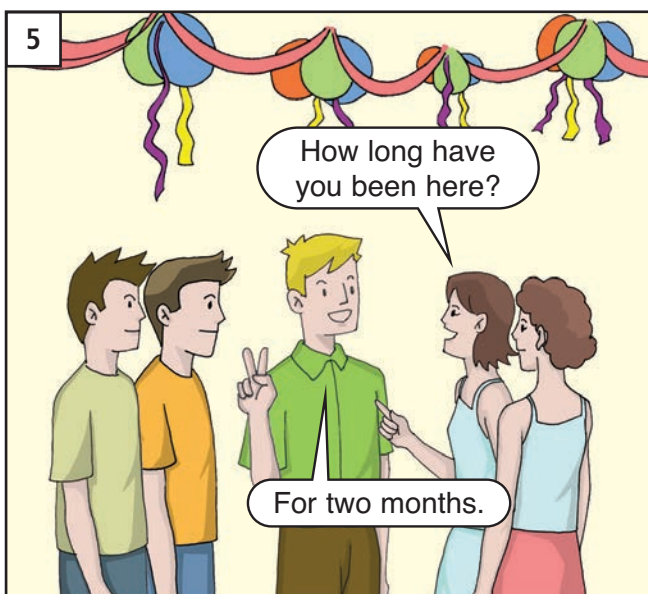

UNIT 9: This one is better.

rice [raɪs]
bread [bred]
potato
 [pə'teɪ'təʊ]
pasta [pɑ:s'tə]
peas [pi:z]
onion [ʌn'jən]
carrot [kær'ət]
tomato
 [təmeɪ'təʊ]
beans [bi:nz]
cauliflower
 [kɔ:'leɪflaʊə:r]
cabbage
 [kæb'ɪdʒ]
broccoli
 [brɑ:k'ɒli:]
cucumber
 [kju:'kʌmbə:r]
lettuce [let'ɪs]
mushroom
 [mʌʃ'ru:m]
ice cream
 [aɪs kri:m]

big [bɪg]
small [smɔ:l]
boring
 [bɔ:r'ɪŋ]
interesting
 [ɪn'trɪstɪŋ]
cheap [tʃi:p]
expensive
 [ɪkspen'sɪv]
tall [tɔ:l]
short [ʃɔ:rt]
heavy [he'vi:]
light [laɪt]
wide [waɪd]
narrow [nær'əʊ]
good [gʊd]
bad [bæd]

bigger [bɪ'gɜ:r]
smaller [smɔ:'lə:r]
more boring
 [mɔ:r bɔ:r'ɪŋ]
more interesting
 [mɔ:r ɪn'trɪstɪŋ]
cheaper [tʃi:'peər]
more expensive
 [mɔ:r ɪkspen'sɪv]
taller [tɔ:'lə:r]
shorter [ʃɔ:rt'ə:r]
heavier [he'vi:ə:r]
lighter [laɪt'ə:r]
wider [waɪd'ə:r]
narrower [nær'əʊə:r]
better [bet'ə:r]
worse [wɜ:rs]

biggest [bɪ'gɪst]
smallest [smɔ:'lɪst]
most boring
 [məʊst bɔ:r'ɪŋ]
most interesting
 [məʊst ɪn'trɪstɪŋ]
cheapest [tʃi:'pi:st]
most expensive
 [məʊst ɪkspen'sɪv]
tallest [tɔ:'lɪst]
shortest [ʃɔ:rt'ɪst]
heaviest [he'vi:ɪst]
lightest [laɪt'ɪst]
widest [waɪd'ɪst]
narrowest [nær'əʊɪst]
best [best]
worst [wɜ:rst]

very [ve:r'i:]
very much [ve:r'i: mʌtʃ]

What do you think? [wʌt du: ju: θɪŋk]
Do you like... ? [du: ju: laɪk]
Can I help you? [kæn aɪ help ju:]

agree [əgri:]
think [θɪŋk]
like [laɪk]

suitcase [su:t'keɪs]
pair of sunglasses [pe:r ʌv sʌn'glæsɪz]
cap [kæp]
surfboard [sɜ:rf'bɔ:rd]
basketball player [bæs'kɪtbɔ:l pleɪ'ə:r]
jockey [dʒɑ:k'i:]
horse [hɔ:rs]
pants [pænts]

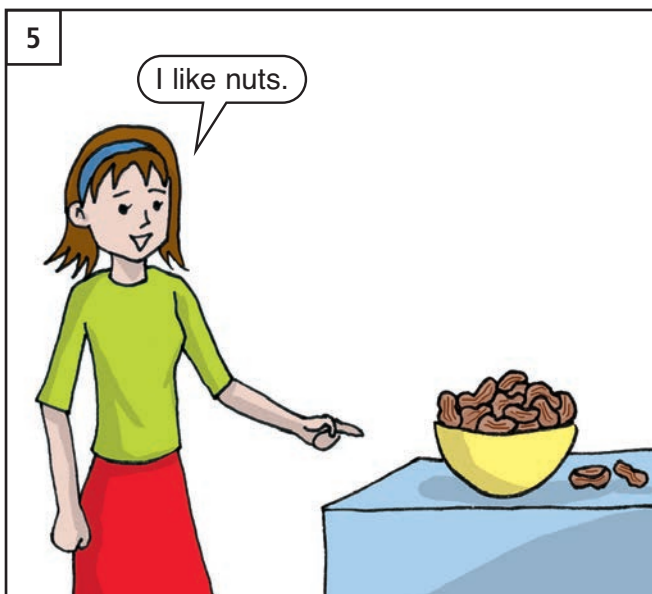
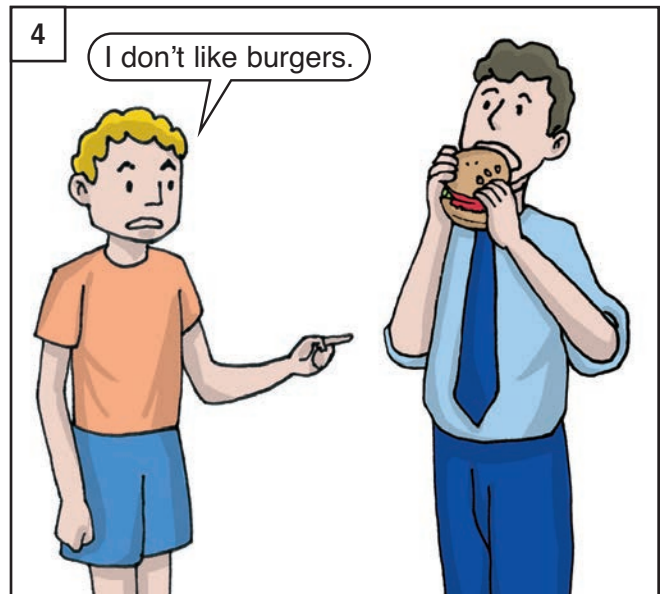
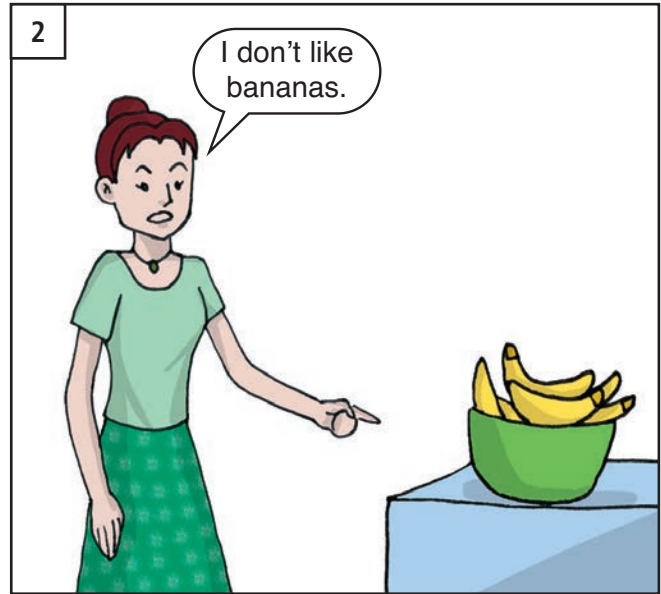
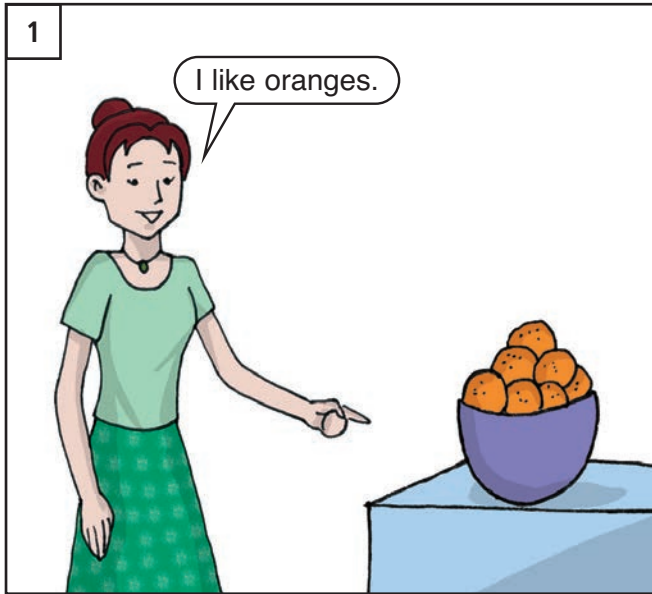

UNIT 9



Do you like...?

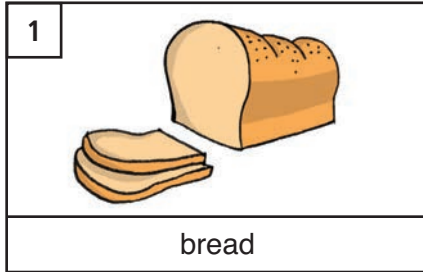

bread

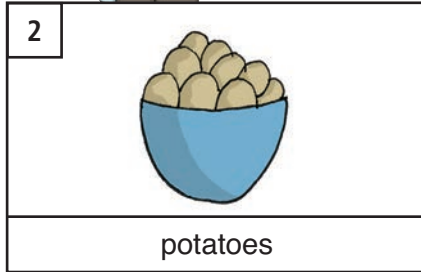

potatoes

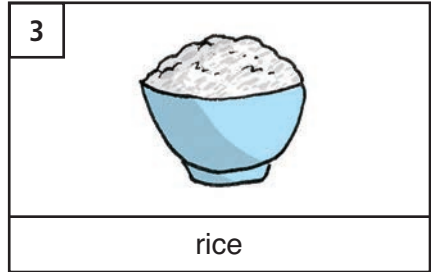

rice

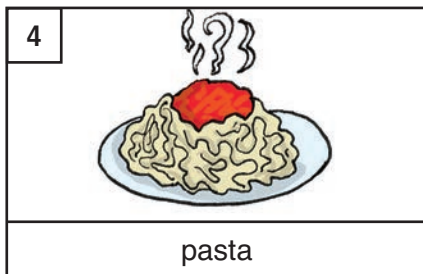

pasta

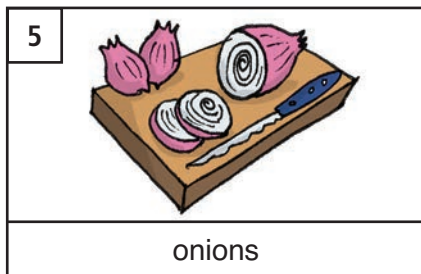

onions

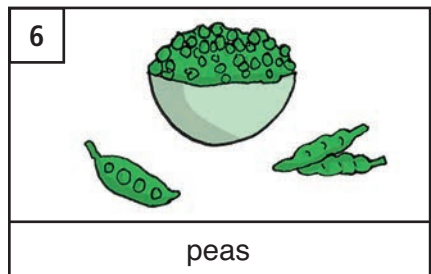

peas

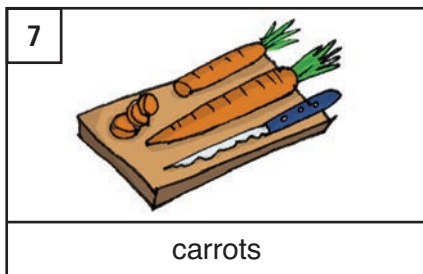

carrots

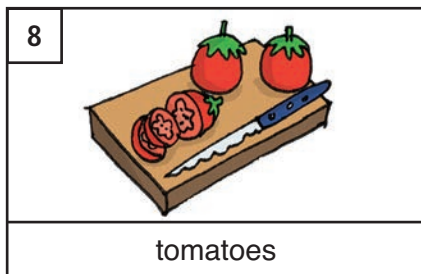

tomatoes

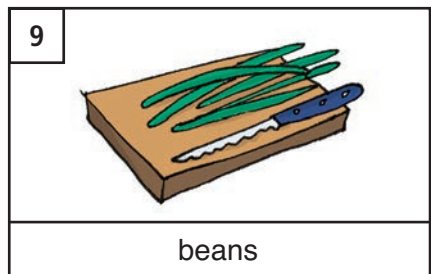

beans

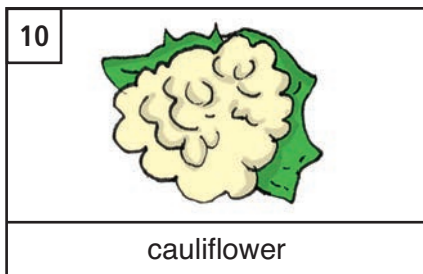

cauliflower

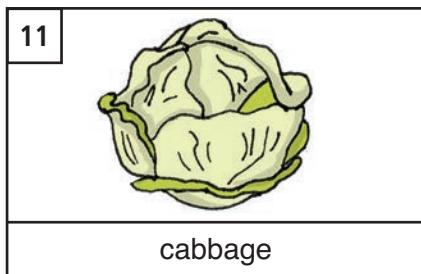

cabbage

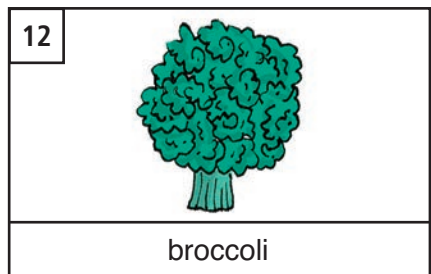

broccoli

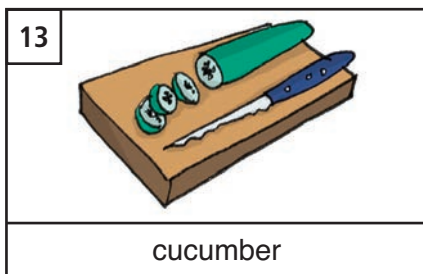

cucumber

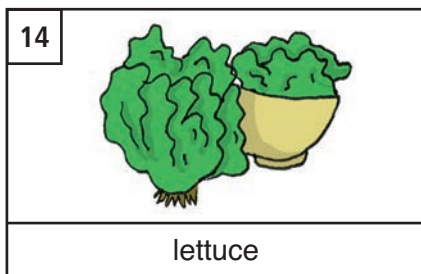

lettuce

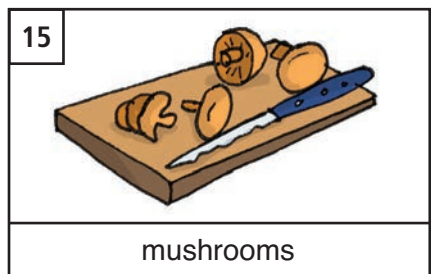

mushrooms



Yes, I do.



No, I don't.

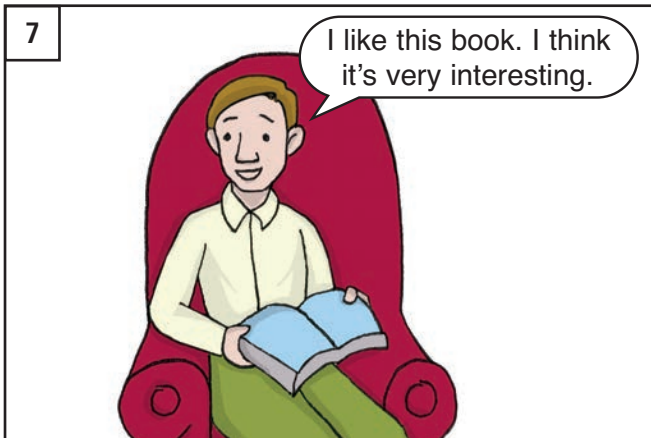
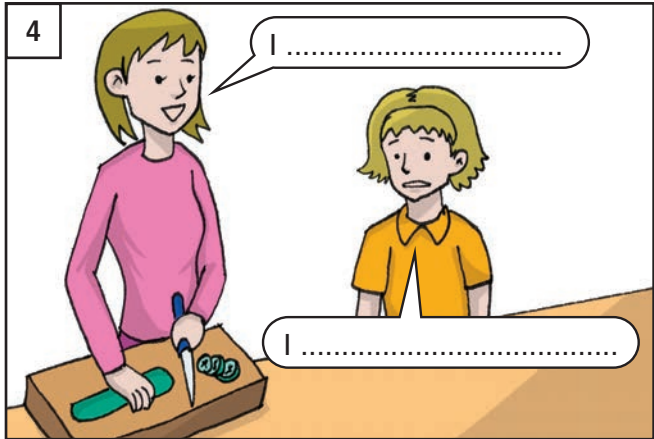
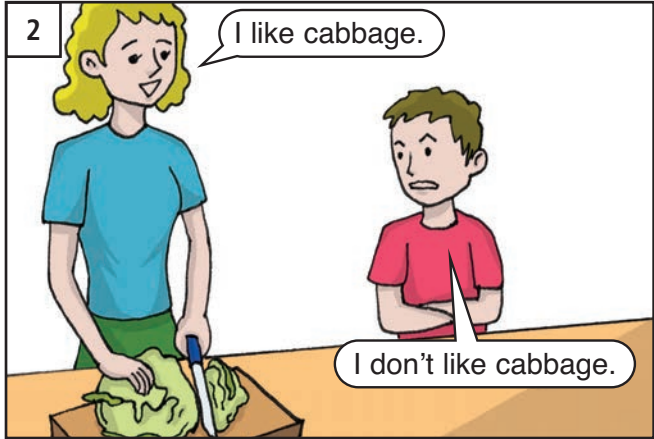

UNIT 9

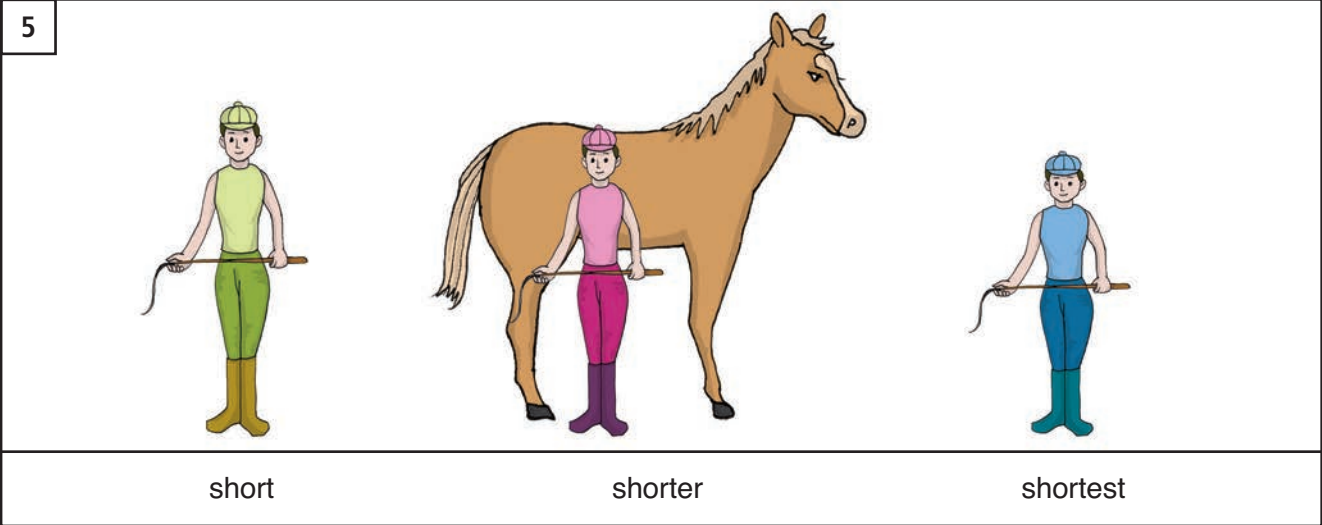
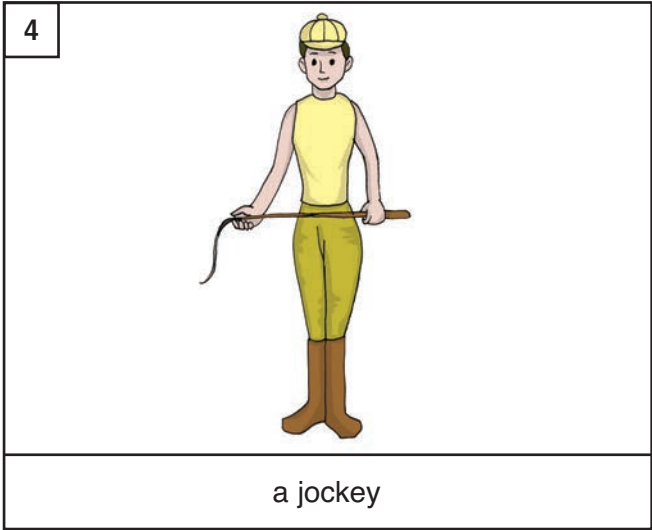
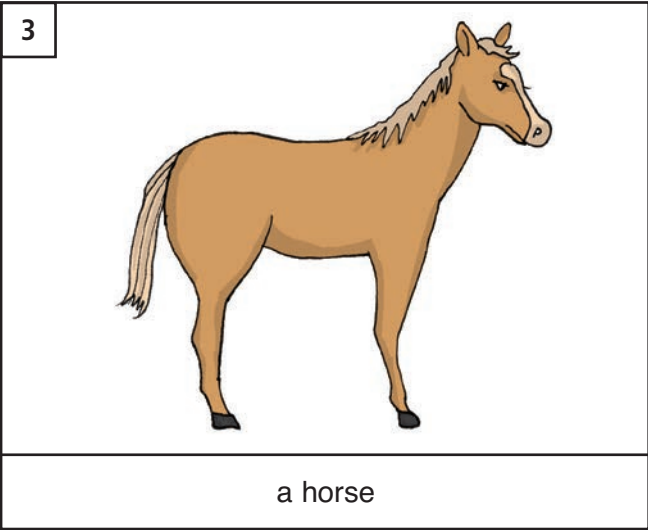
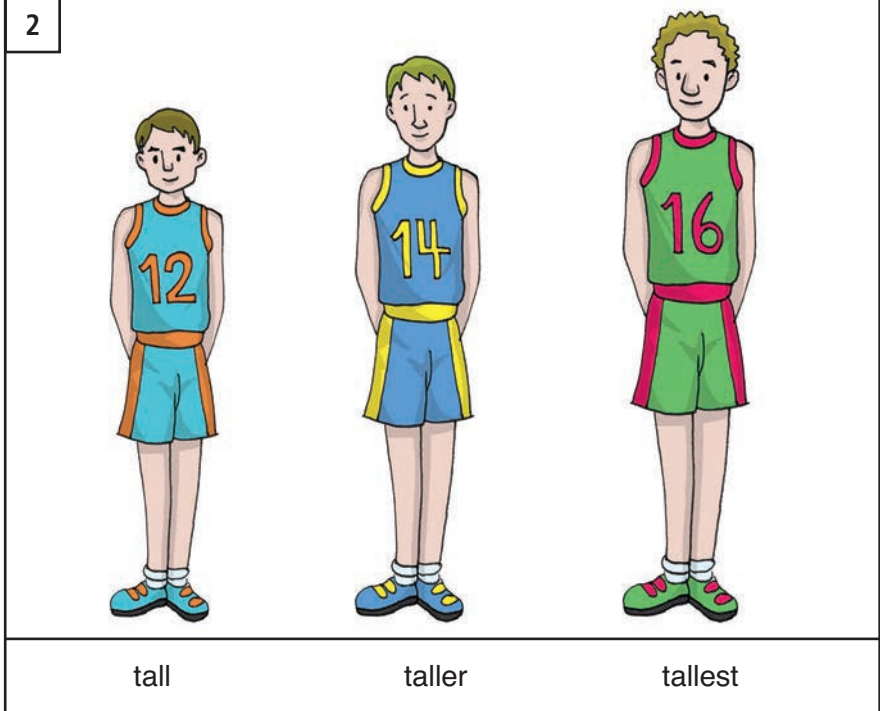

This one is better.

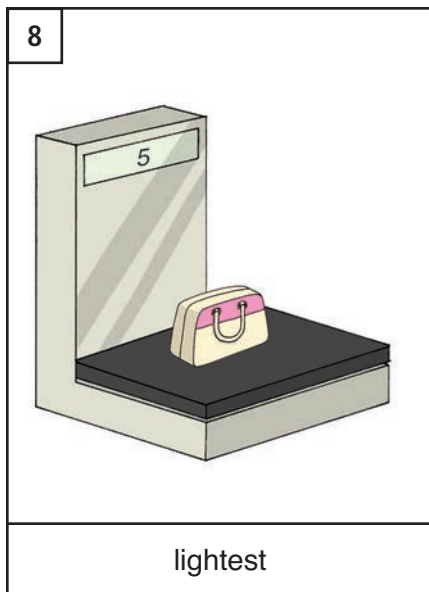
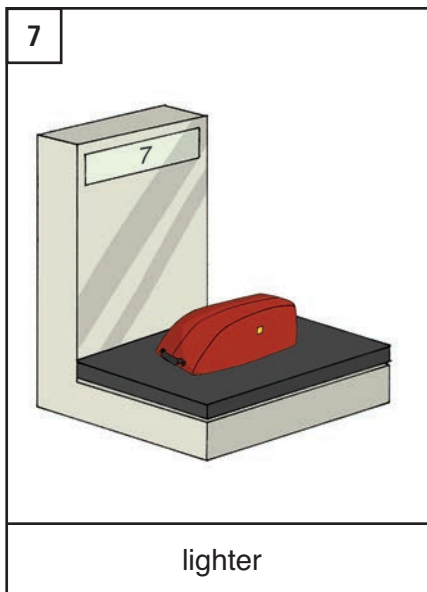
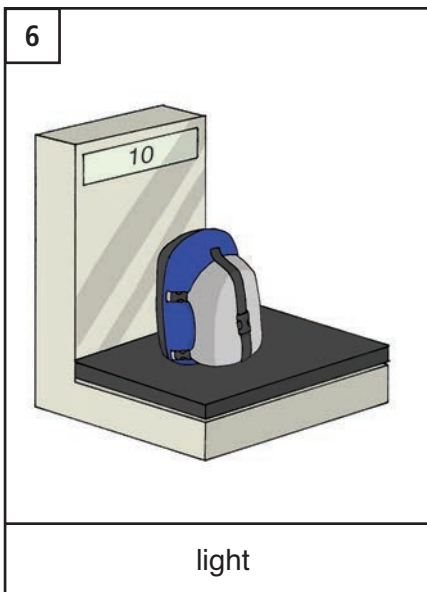
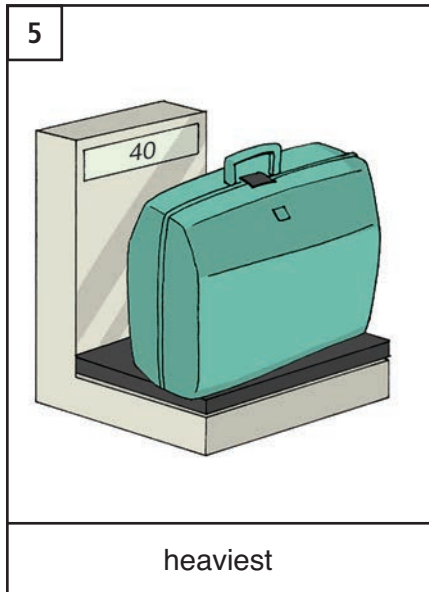
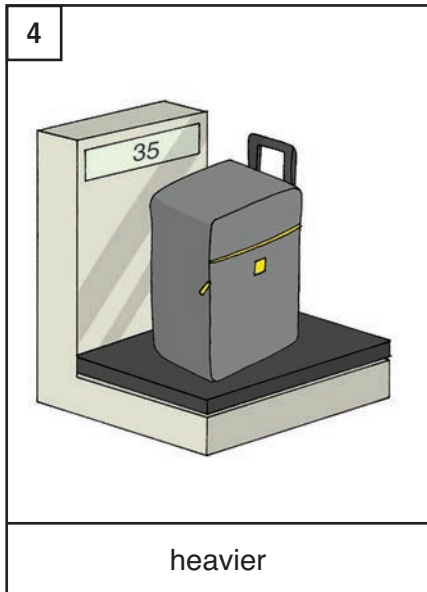
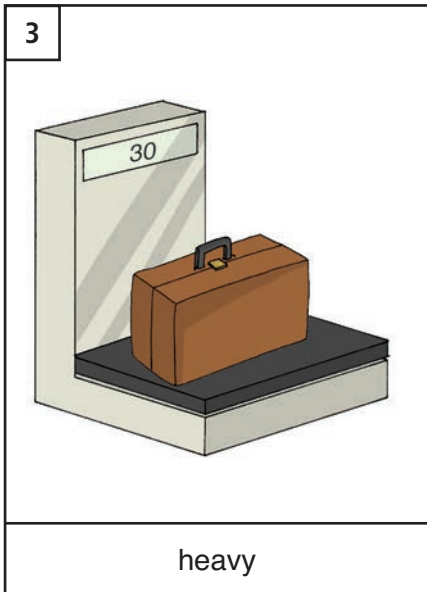
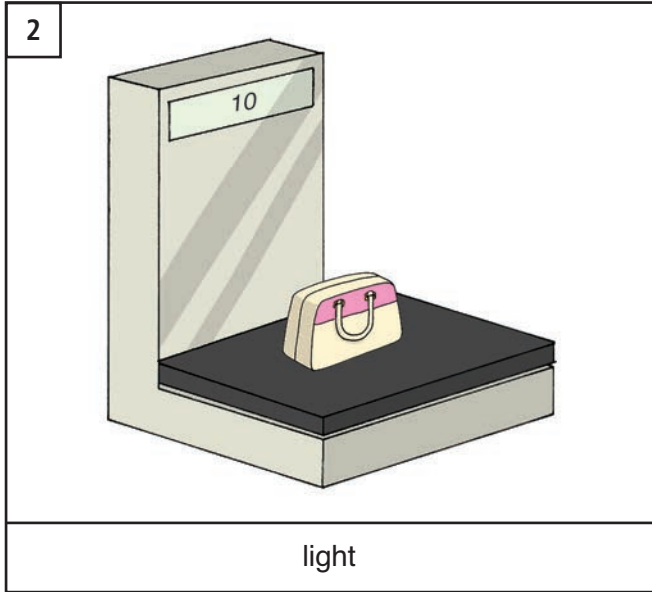
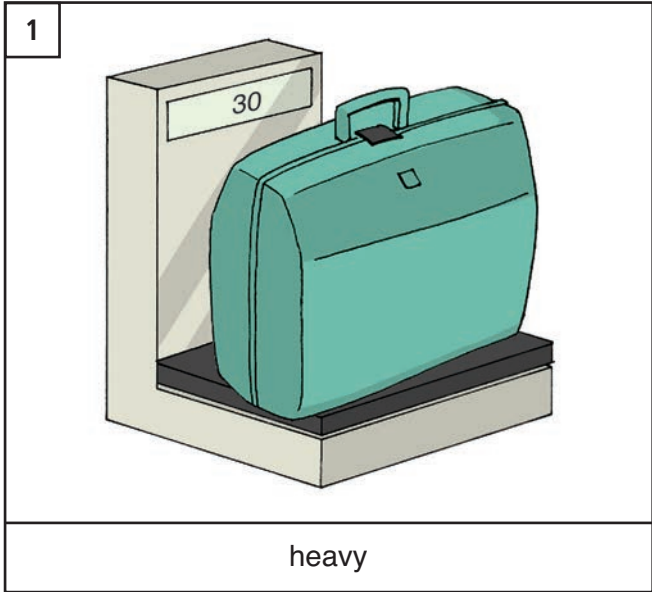

UNIT 9

1



a pair of sunglasses

2



expensive more expensive most expensive

3



cheap cheaper cheapest

4

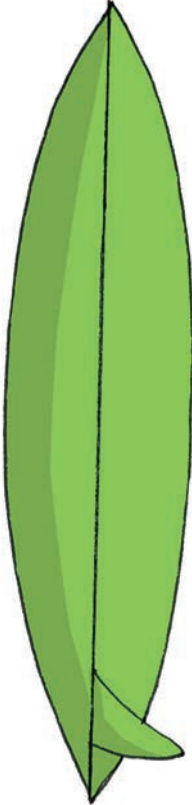

a surfboard

5

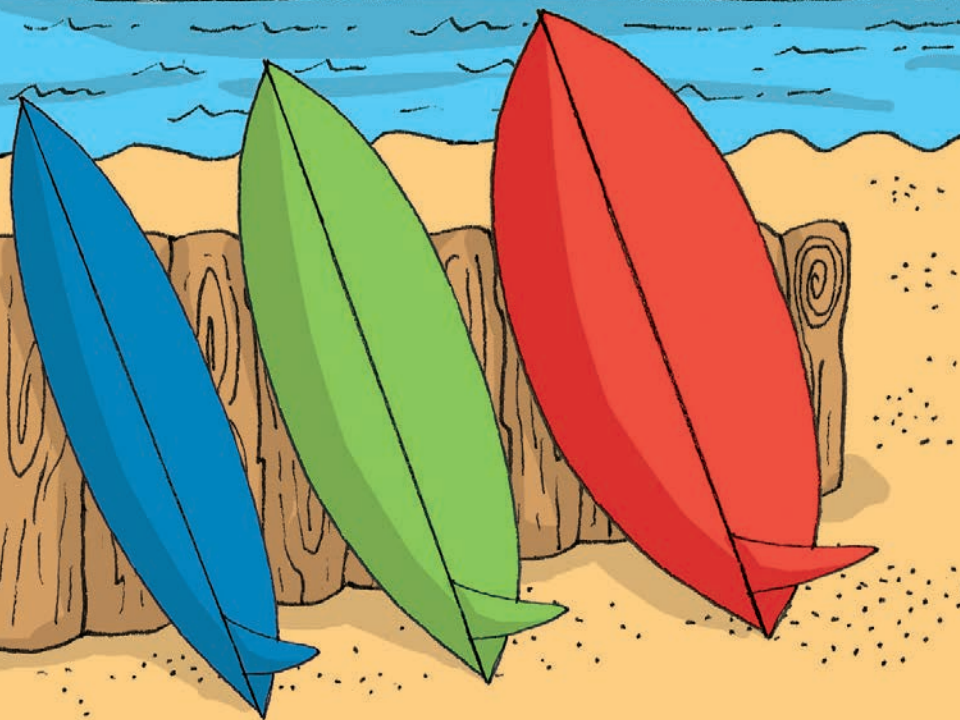

wide wider widest

This one is better.

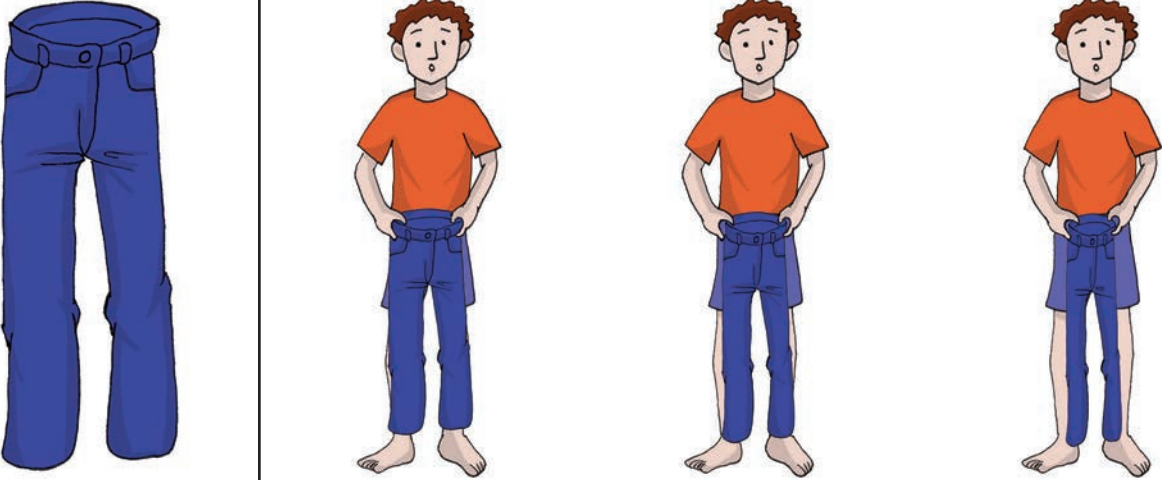
1	
pants	narrow narrower narrowest

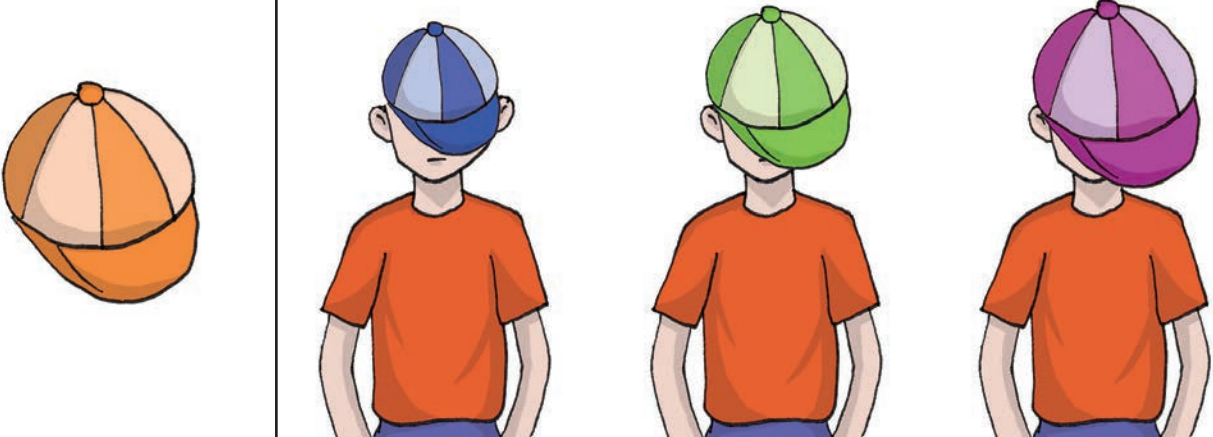
2	
a cap	big bigger biggest

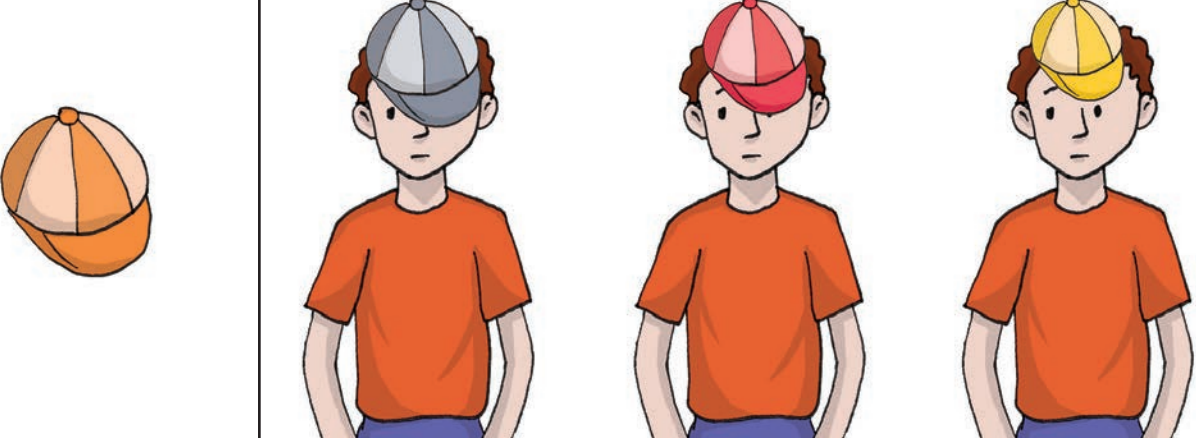
3	
a cap	small smaller smallest

UNIT 9

1

good better best

2

bad worse worst

3

RESTAURANT

RESTAURANT

I think this restaurant is good. What do you think?

4

RESTAURANT

RESTAURANT

I think this one is better.

5

I like that suitcase. What do you think?

6

Yes, I think it's a good one, but that one is better. I like it very much.

The Bensons

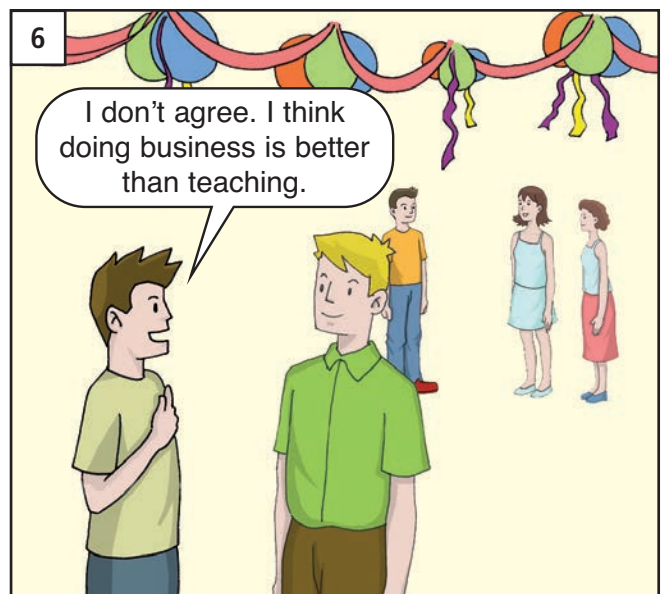
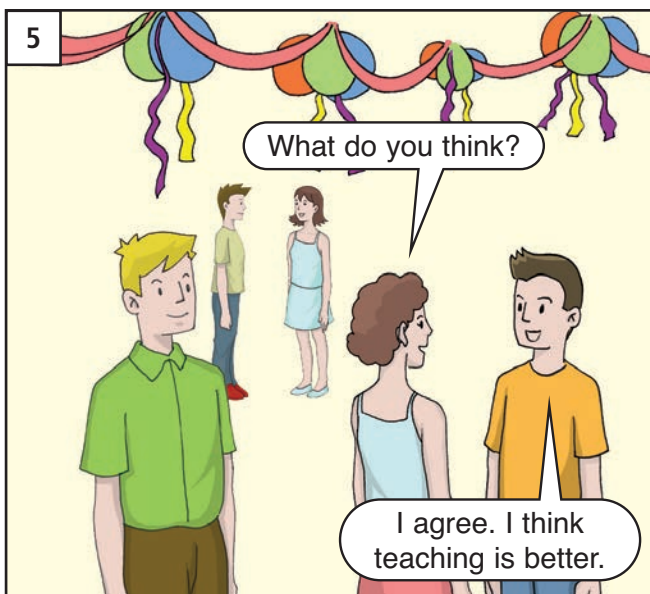
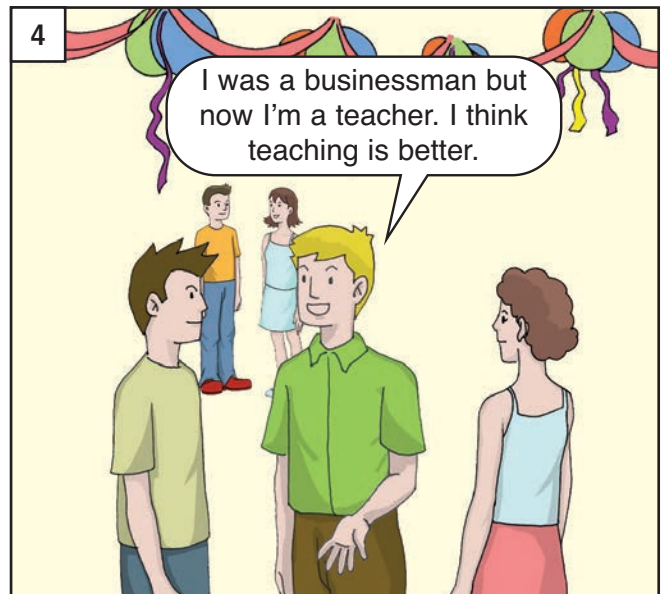
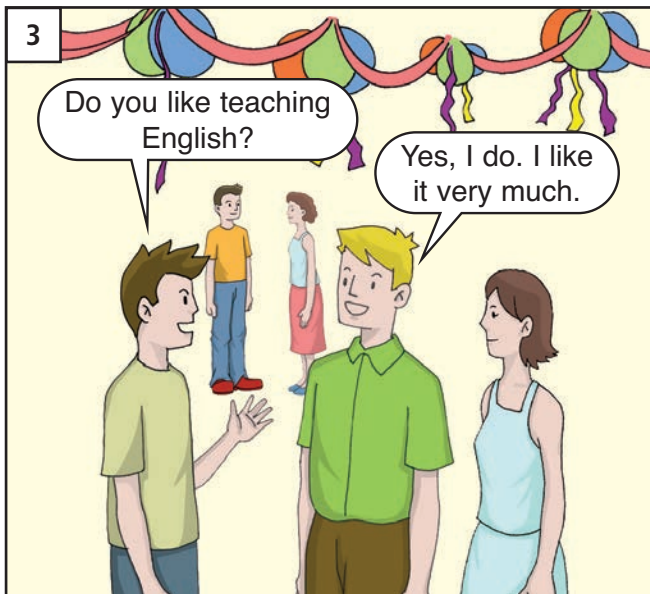
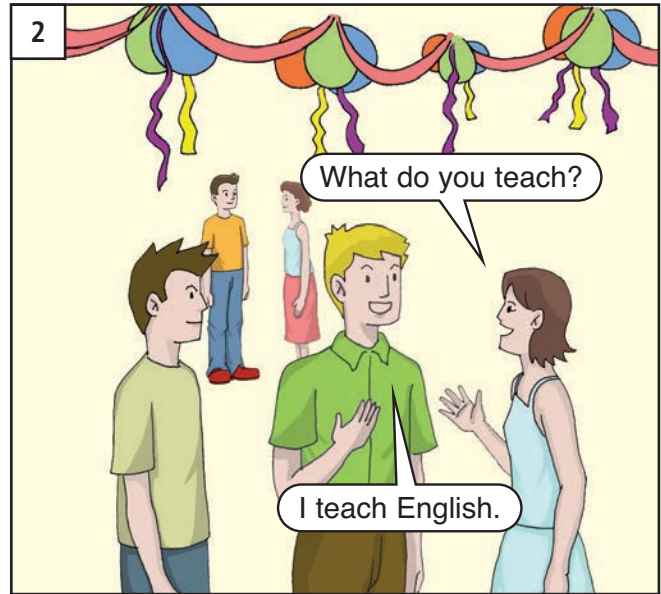
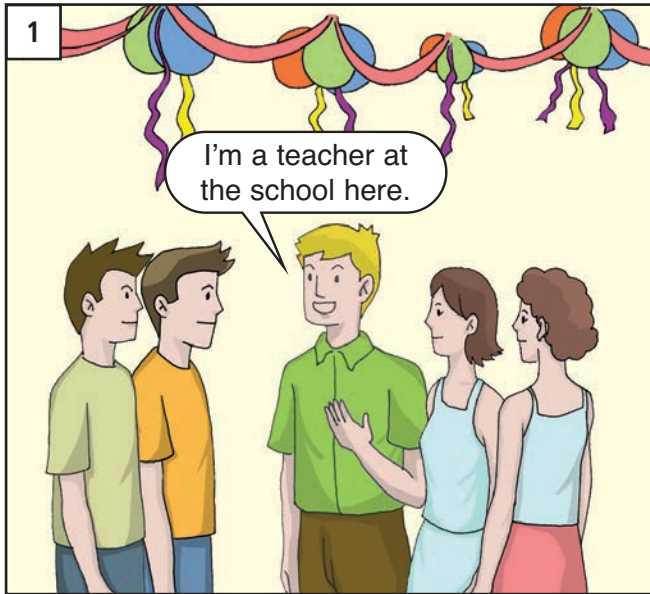

UNIT 10: Revision and extension

1



apple
.....

2



.....

3



.....

4



.....

5

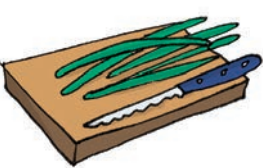

.....

6

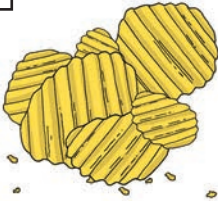

.....

7

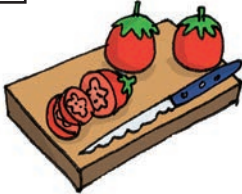

.....

8



.....

9

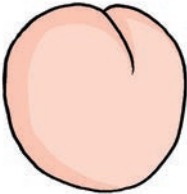

.....

10

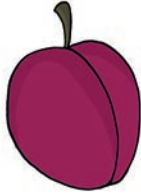

.....

11



.....

12



.....

13



.....

14



.....

15



.....

16

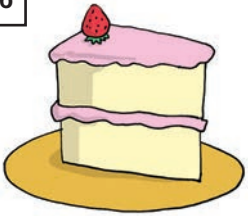

.....

17

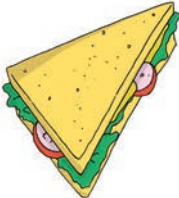

.....

18

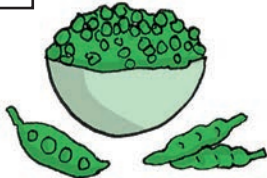

.....

19



.....

20



.....

21

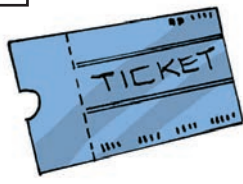

.....

22



.....

23



.....

24

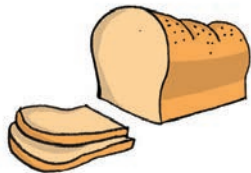

.....

25



.....

26



.....

27



.....

28



.....

29



.....

30



.....

31



.....

32

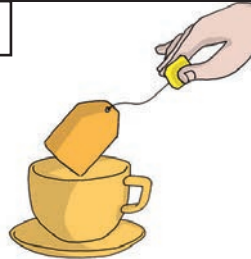

.....

33



.....

34

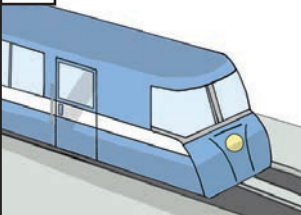

.....

35

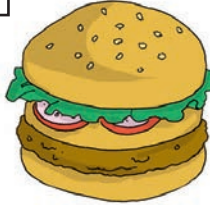

.....

36



.....

37

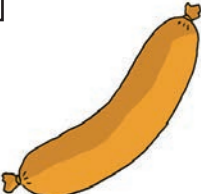

.....

38



.....

39



.....

40



.....

UNIT 10

A

- | | |
|------------------------------------|----------------------------|
| 1. Would you like a glass of milk? | a. An apple would be nice. |
| 2. She's tall, isn't she? | b. No, I don't. |
| 3. Do you like this restaurant? | c. No, thank you. |
| 4. What would you like? | d. Yes, she is. |

B

- | | |
|------------------------------|-----------------------------|
| 1. What do you do? | a. He was a police officer. |
| 2. What did you do? | b. I was a teacher. |
| 3. When were you a teacher? | c. From 1991 to 1996. |
| 4. What did your brother do? | d. I'm a taxi driver. |

C

- | | |
|---------------------------------|--------------------|
| 1. Where are you from? | a. Three weeks. |
| 2. How long have you been here? | b. Yes, I do. |
| 3. How did you get here? | c. By train. |
| 4. Do you like this hotel? | d. I'm from Tokyo. |

D

- | | |
|-----------------------------|--------------------------------|
| 1. This watch is expensive. | a. This one is bigger. |
| 2. This house is big. | b. This one is more expensive. |
| 3. Those books are cheap. | c. Alan runs faster. |
| 4. Max runs fast. | d. These are cheaper. |

Can eat glass of piece of something like



UNIT 10

can't take too I you your

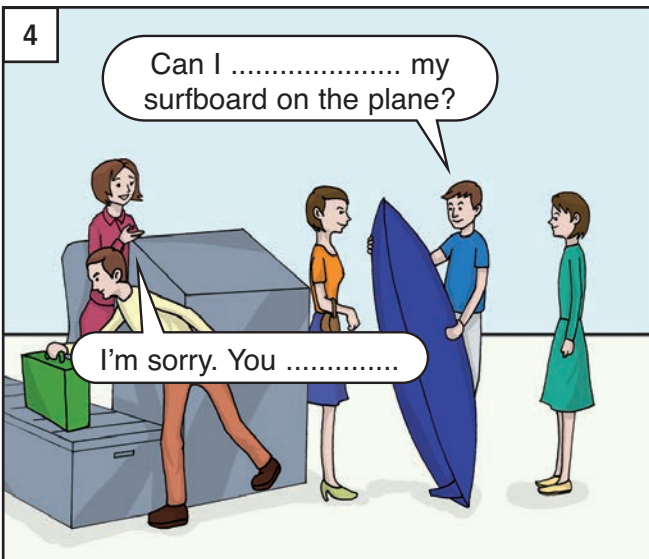
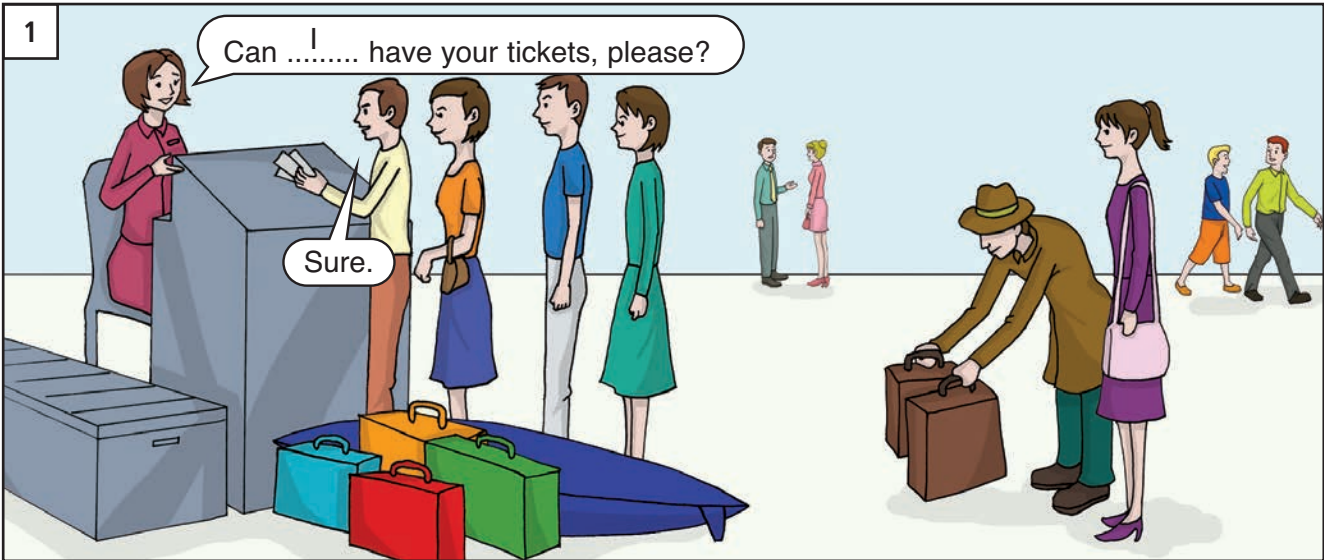

about most heavier isn't it Sure do looks me



UNIT 10

think by long from much since here For agree

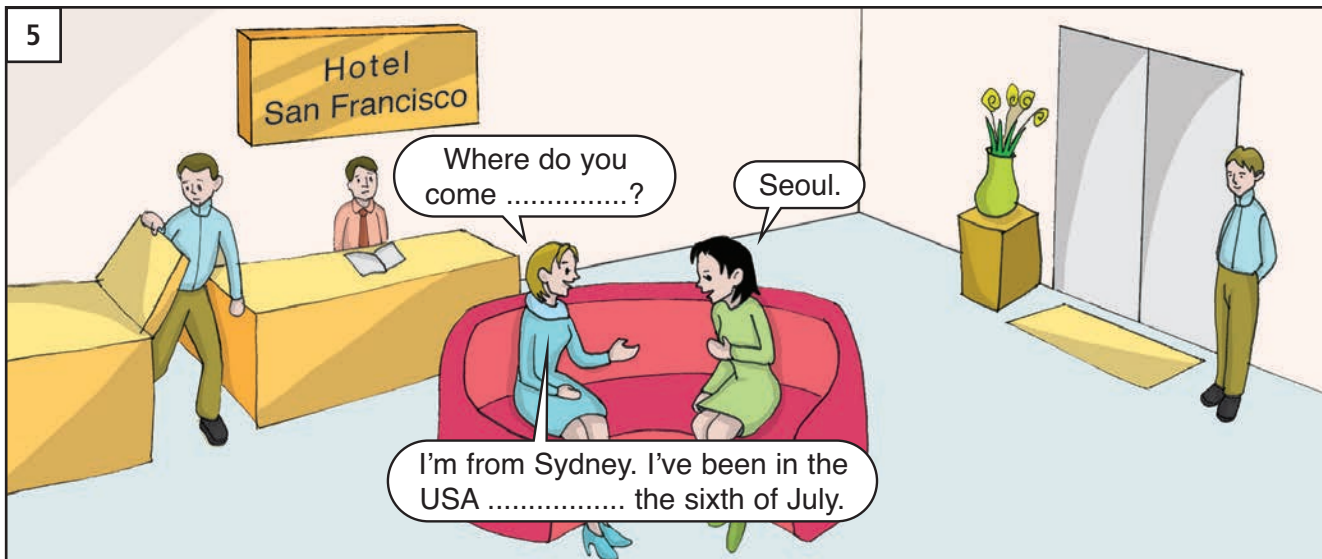
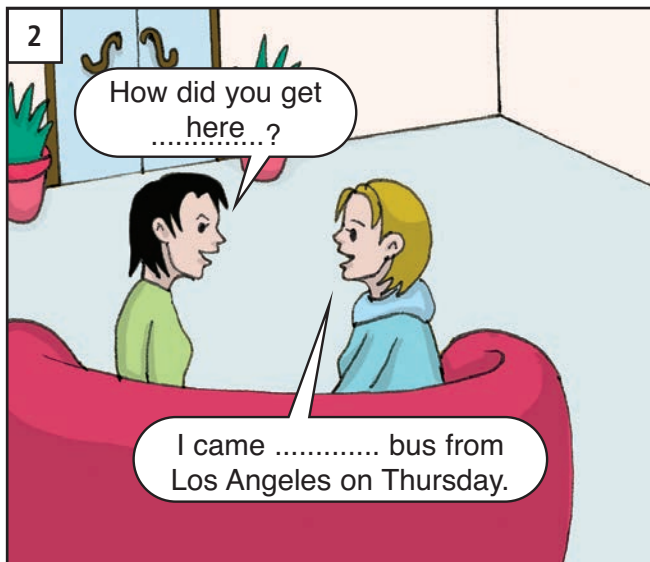

Revision and extension



- to something you eat Would like
- be nice chips Some would



- cup you coffee Would a of like
- please Yes

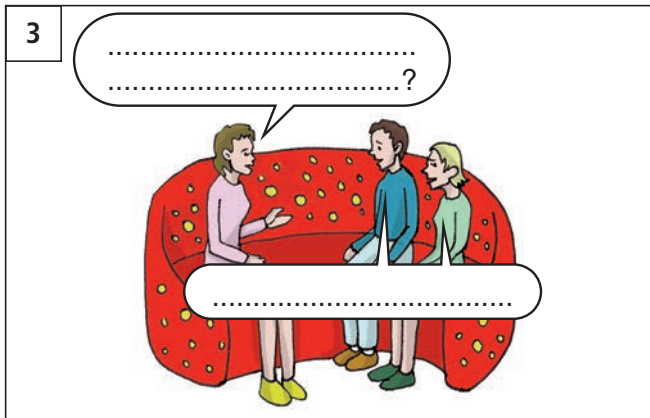

- here you long have How been
- months two For

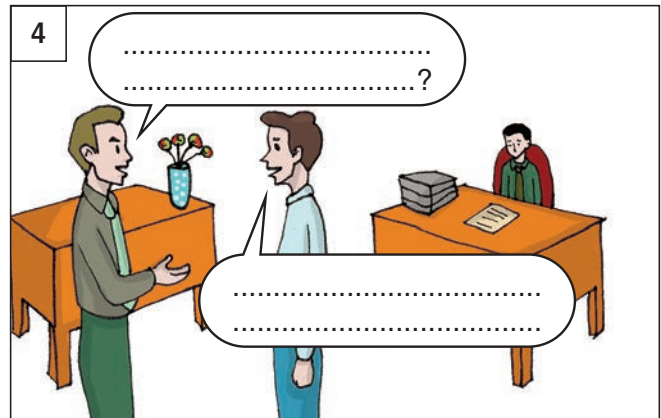

- here been How you long have
- seventeenth Since September of the

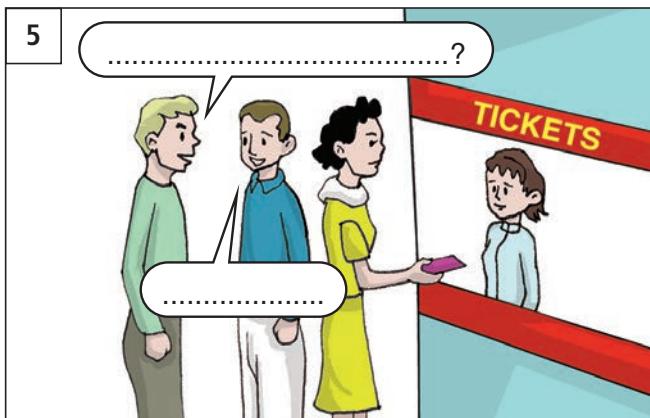

- get did you here How
- taxi By



- from Where you are
- San Francisco from I'm

UNIT 10



- Los Angeles of What think you do
- I interesting is think more San Francisco

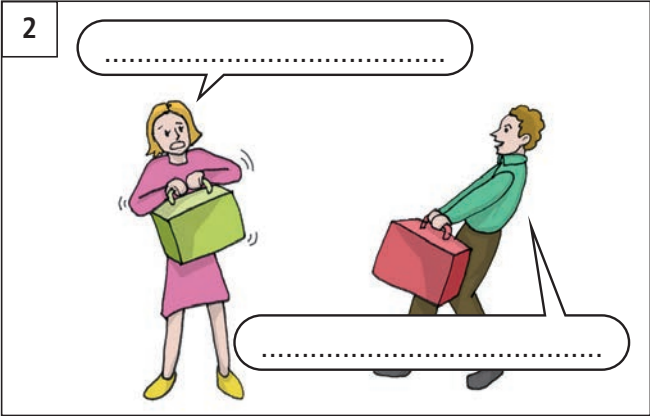

- is suitcase This heavier
- this one bigger Yes is but



- ???
- sorry that repeat Could please I'm you



- like movie you the Did
- boring No was It



- cake like you Do
- much Yes very I it like



- you do do What
- manager a I'm

UNIT 10: Answers

Unit 10, page 82

- | | | | |
|----------------------------|----------|--------------|-------------------|
| 1. apple | 2. bag | 3. banana | 4. cookie |
| 5. beans | 6. chips | 7. tomatoes | 8. cucumber |
| 9. peach | 10. plum | 11. suitcase | 12. nurse |
| 13. bottle of orange juice | 14. nuts | 15. orange | 16. piece of cake |
| 17. sandwich | 18. peas | 19. cap | 20. tablets |

Unit 10, page 83

- | | | | |
|------------------|----------------------|------------------------|--------------------|
| 21. ticket | 22. lettuce | 23. onions | 24. bread |
| 25. doctor | 26. teacher | 27. mechanic | 28. police officer |
| 29. receptionist | 30. sales assistants | 31. taxi driver | 32. tea |
| 33. bus | 34. train | 35. burger | 36. socks |
| 37. sausage | 38. mushrooms | 39. pair of sunglasses | 40. carrots |

Unit 10, page 84

- | | | | |
|----------------|----------------|----------------|----------------|
| A. 1c 2d 3b 4a | B. 1d 2b 3c 4a | C. 1d 2a 3c 4b | D. 1b 2a 3d 4c |
|----------------|----------------|----------------|----------------|

Unit 10, page 85

- | | | | | |
|--------------|-----------------------|--------|---------|--------|
| 1. something | 2. piece of, glass of | 3. Can | 4. like | 5. eat |
|--------------|-----------------------|--------|---------|--------|

Unit 10, page 86

- | | | | |
|------|--------------|--------|----------------|
| 1. I | 2. your, too | 3. you | 4. take, can't |
|------|--------------|--------|----------------|

Unit 10, page 87

- | | | | | | |
|-------|---------|---------|----------------------|----------|--------------|
| 1. me | 2. Sure | 3. most | 4. isn't it, heavier | 5. about | 6. do, looks |
|-------|---------|---------|----------------------|----------|--------------|

Unit 10, page 88

- | | | | |
|-------------|--------------|-----------------------|----------------|
| 2. here, by | 3. long, For | 4. think, much, agree | 5. from, since |
|-------------|--------------|-----------------------|----------------|

Unit 10, page 89

1. Would you like something to eat?
Some chips would be nice.
2. Would you like a cup of coffee?
Yes, please.
3. How long have you been here?
For two months.
4. How long have you been here?
Since the seventeenth of September.
5. How did you get here?
By taxi.
6. Where are you from?
I'm from San Francisco.

Unit 10, page 90

1. What do you think of Los Angeles?
I think San Francisco is more interesting.
2. This suitcase is heavier.
Yes, but this one is bigger.
3. I'm sorry. Could you repeat that please?
4. Did you like the movie?
No. It was boring.
5. Do you like cake?
Yes. I like it very much.
6. What do you do?
I'm a manager.

UNIT 11: What's the matter?

Are you all right? [a:r ju: ɔ:l rait]

What's the matter? [wʌts ðə mət'ə:r]

What's wrong? [wʌts rɔ:ŋ]

Sorry. [sa:r'ɪ:]

I'm sorry to hear that. [aim sa:r'ɪ: tu: hi:r ðæt]

Thanks for coming. [θæŋks fɔ:r kʌm'ɪŋ]

hurts [hə:rts]

headache [hed'eik]

backache [bæk'eik]

stomachache [stʌm'əkeik]

earache [i:r'eik]

toothache [tu:θ'eik]

Keep right. [ki:p rait]

back [bæk]

ear [i:r]

foot [fut]

hand [hænd]

head [hed]

knee [ni:]

leg [leg]

arm [a:rm]

shoulder [ʃoul'də:r]

stomach [stʌm'ək]

tooth [tu:θ]

go home [gou houn]

have to [hæv tu:]

pay [pei]

stop [sta:p]

take [teik]

sun [sʌn]

moon [mu:n]

stars [sta:rz]

Good morning. [gud mɔ:r'niŋ]

Good afternoon. [gud æftə:rnu:n']

Good evening. [gud i:v'niŋ]

Good night. [gud nait]

Goodbye. [gudbai']

Bye. [bai]

See you later. [si: ju: lei'tə:r]

Have a nice day. [hæv ə nais dei]

morning [mɔ:r'niŋ]

afternoon [æftə:rnu:n']

evening [i:v'niŋ]

night [nait]

day [dei]

bill [bil]

Dad [dæd]

morning + afternoon + evening + night = 1 day

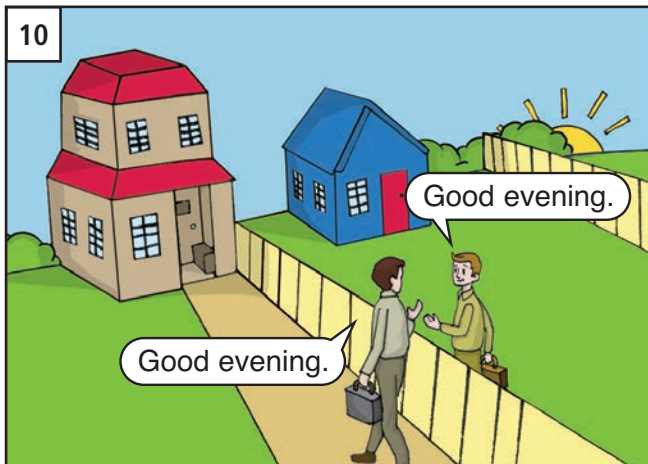
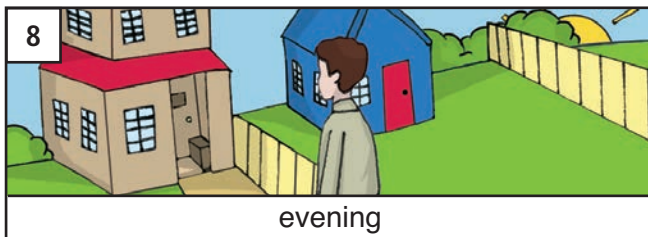
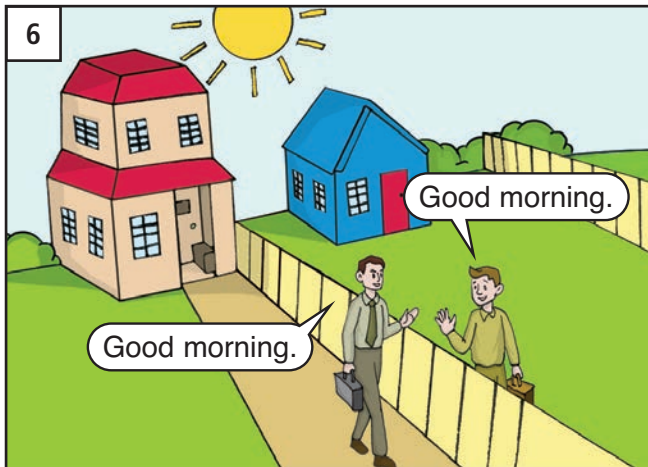
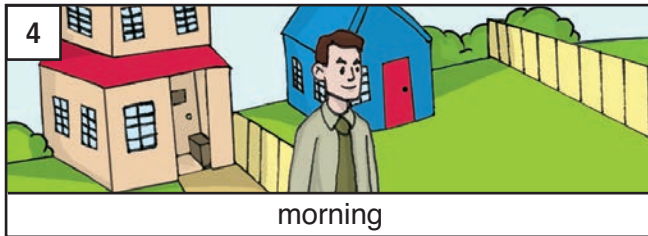
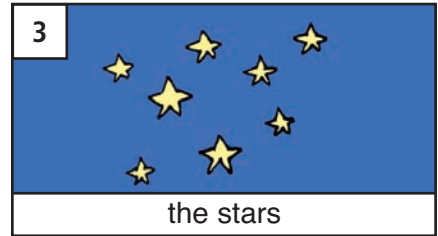
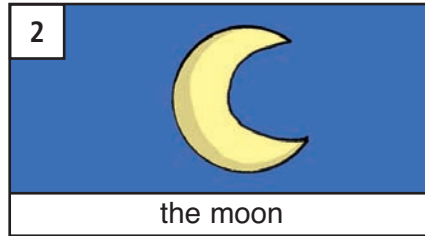
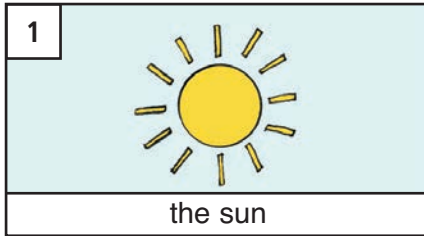



John is = John's

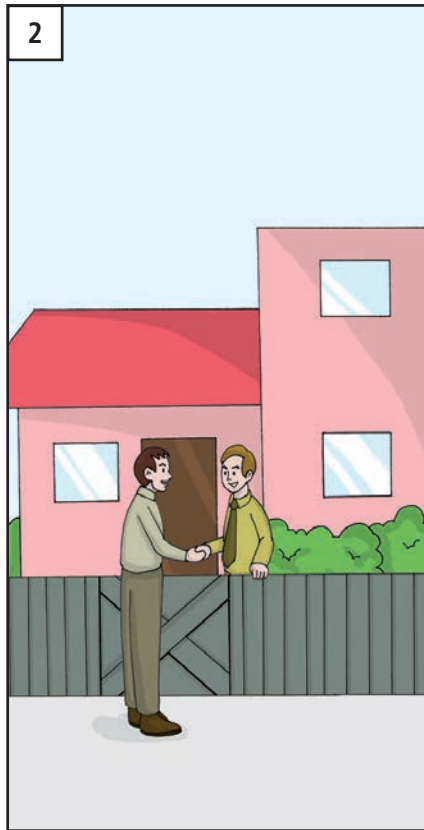
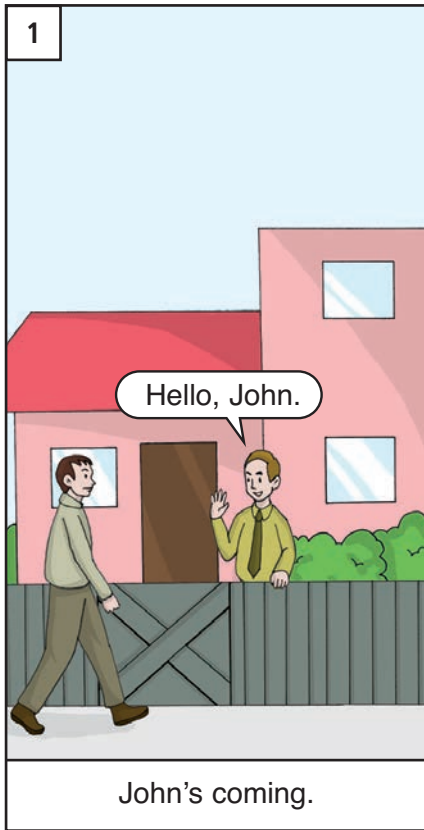

What's the matter?

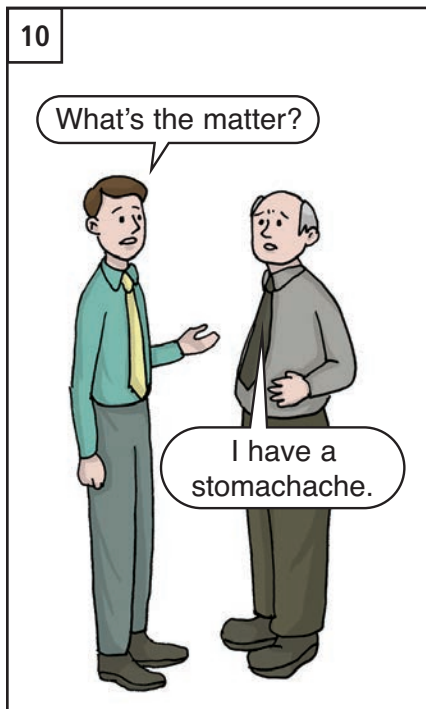
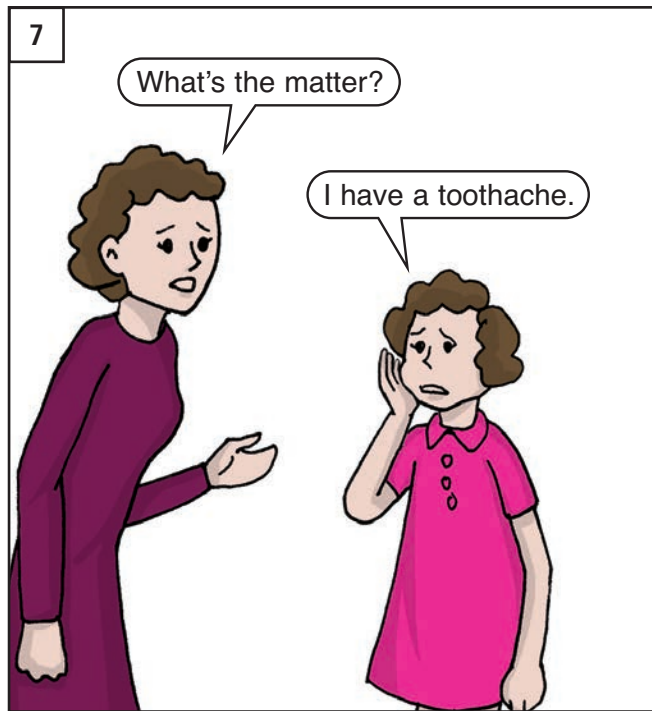
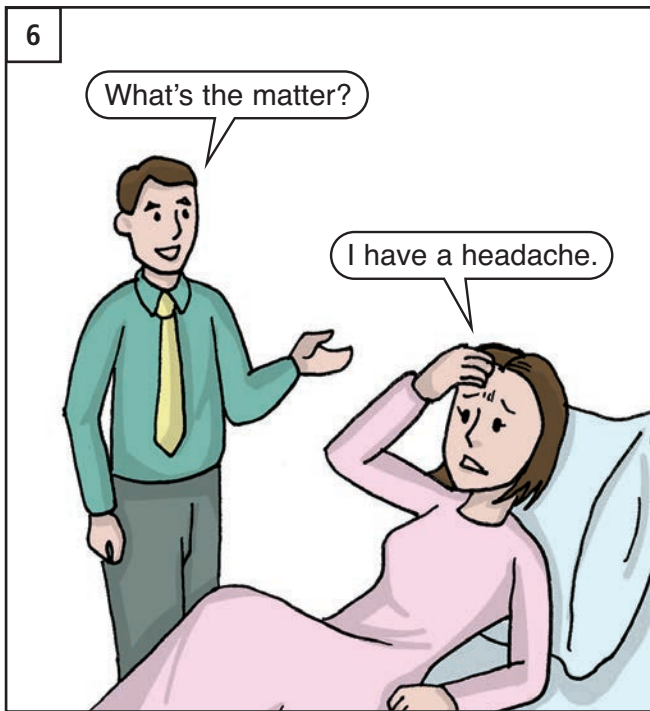
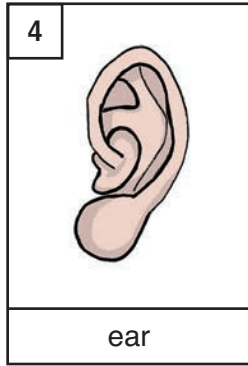
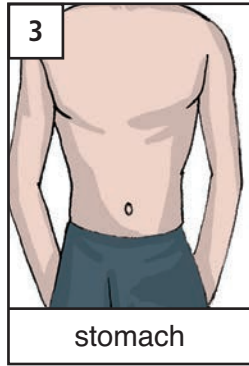
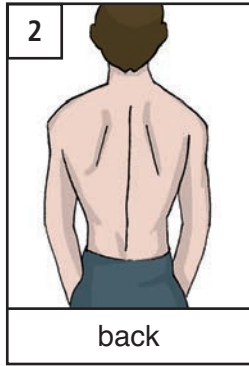

UNIT 11

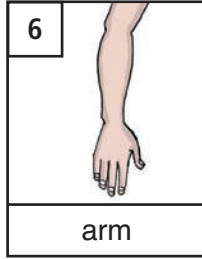
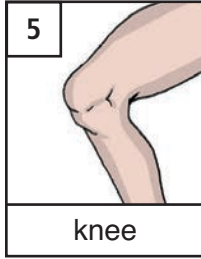
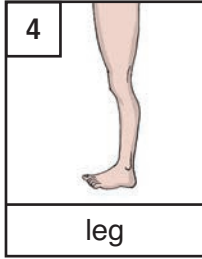
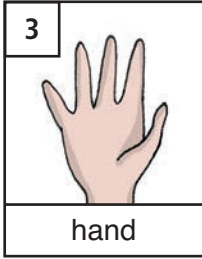
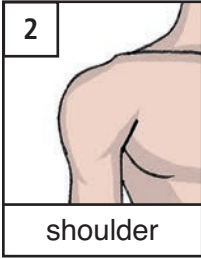
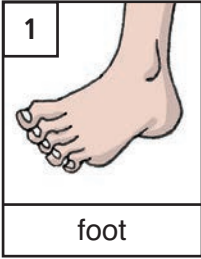

What's the matter?

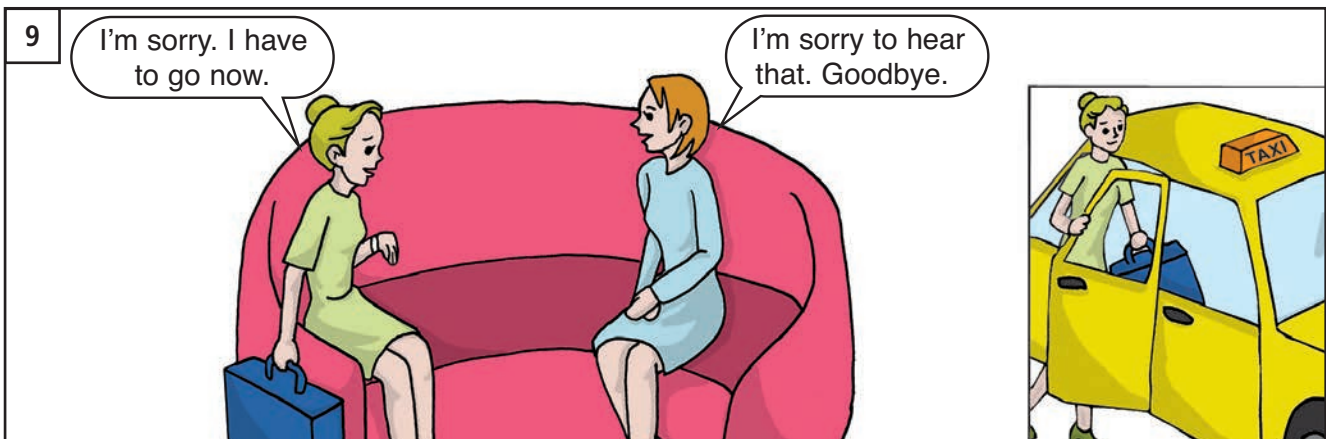
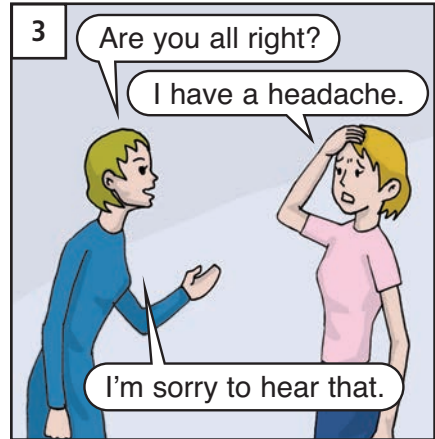

The Bensons

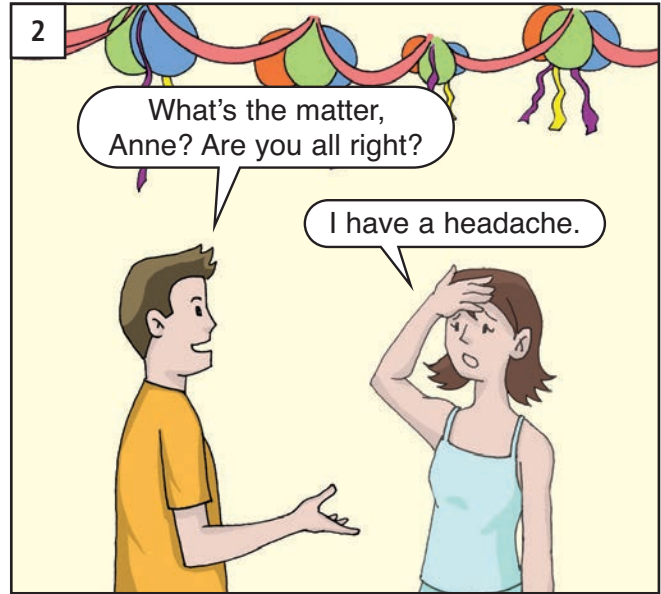
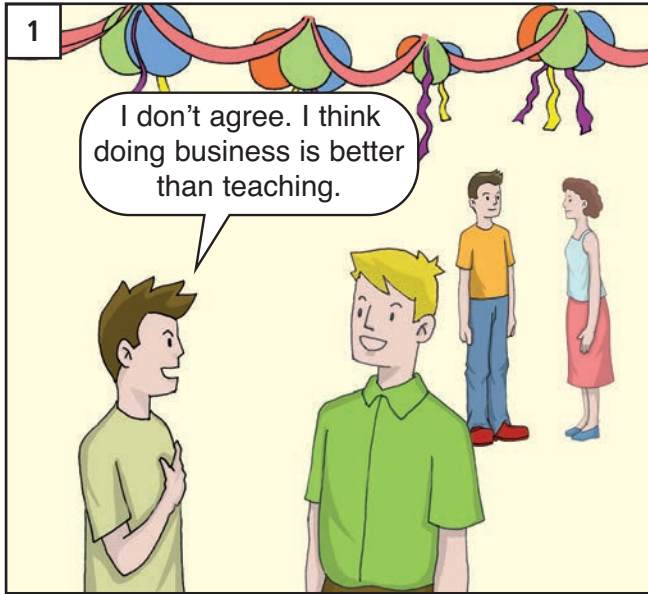



UNIT 12: I live In the big house.

Where do you live? [we:r du: ju: liv]

What's your address? [wʌts ju:r ədresʹ]

I live at... [ai liv æt]

call [kɔ:l]

get [get]

I'll [ail]

will [wil]

hospital [ha:s'pitəl]

police station [pəli:s' stei'ʃən]

twenty-one [twen'ti: wʌn]

twenty-two [twen'ti: tu:]

twenty-three [twen'ti: θri:]

twenty-four [twen'ti: fɔ:r]

twenty-five [twen'ti: faiv]

twenty-six [twen'ti: siks]

twenty-seven [twen'ti: sev'ən]

twenty-eight [twen'ti: eit]

twenty-nine [twen'ti: nain]

thirty [ðə:r'ti:]

near [ni:r]

next door [nekst dɔ:r]

next to [nekst tu:]

opposite [a:p'əzit]

at [æt]

on [a:n]

corner [kɔ:r'nɔ:r]

around the corner [əraund' ðə kɔ:r'nɔ:r]

on the corner [a:n ðə kɔ:r'nɔ:r]

street [stri:t]

road [rɔud]

address [ədresʹ]

card [ka:rd]

thirty-one [ðə:r'ti: wʌn]

forty [fɔ:r'ti:]

fifty [fif'ti:]

sixty [siks'ti:]

seventy [sev'ən ti:]

eighty [ei'ti:]

ninety [nain'ti:]

one hundred [wʌn hun'drid]

two hundred and one

[tu: hun'drid ænd wʌn]

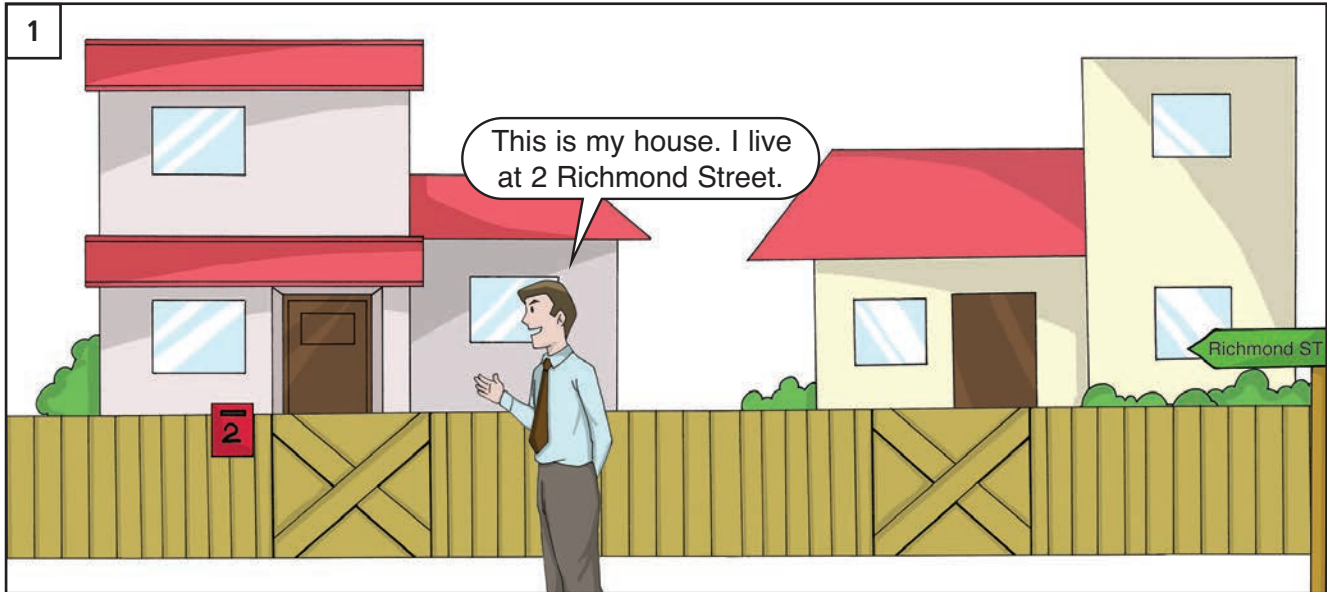

UNIT 12

21
twenty-one

22
twenty-two

23
twenty-three

24
twenty-four

25
twenty-five

26
twenty-six

27
twenty-seven

28
twenty-eight

29
twenty-nine

30
thirty

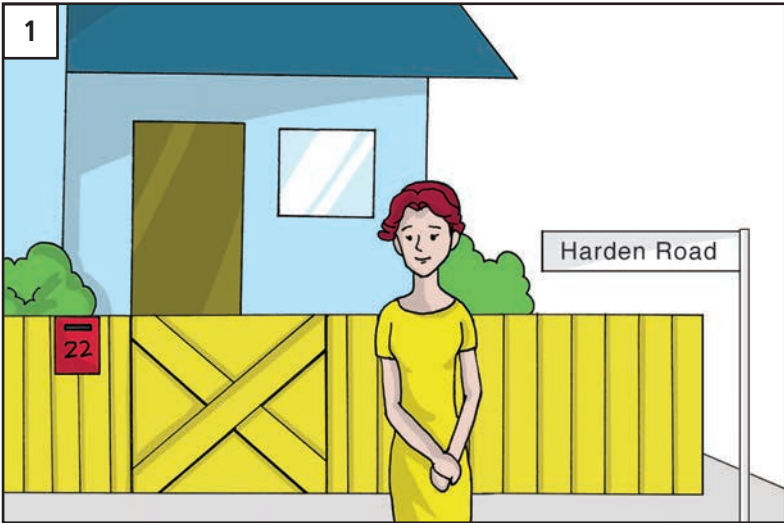

31
thirty-one

40
forty

50
fifty

60
sixty

70
seventy

80
eighty

90
ninety

100
one hundred

200
two hundred

201
two hundred and one

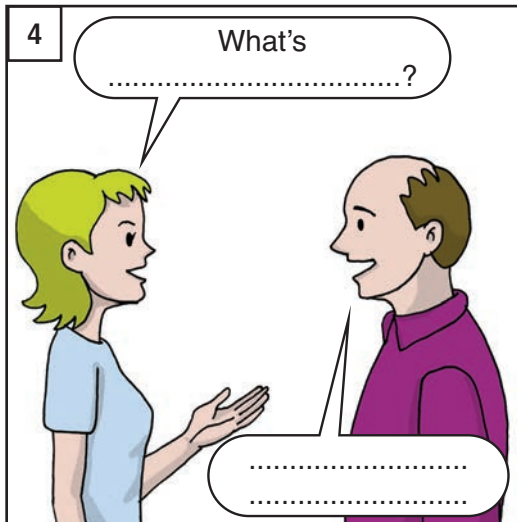
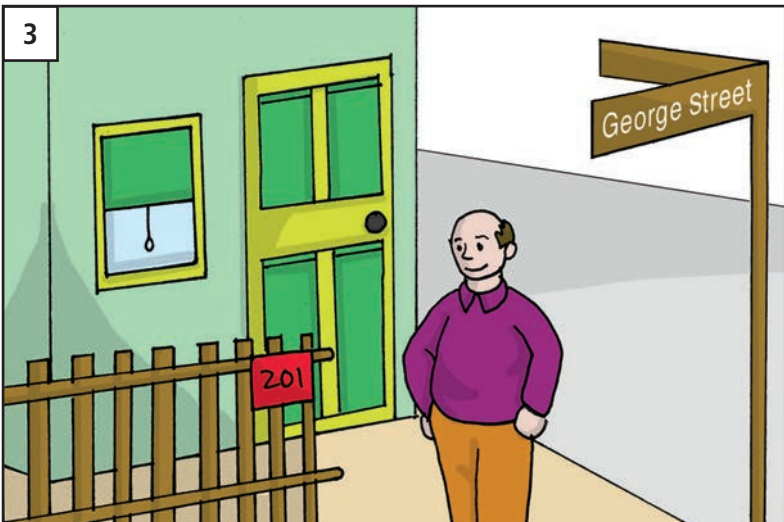

I live in the big house.

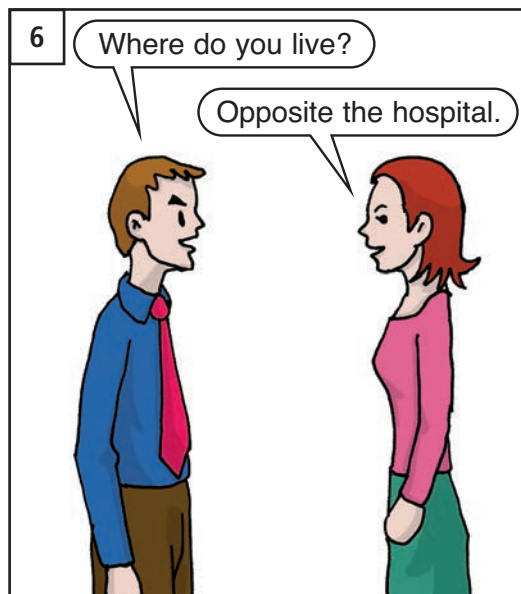
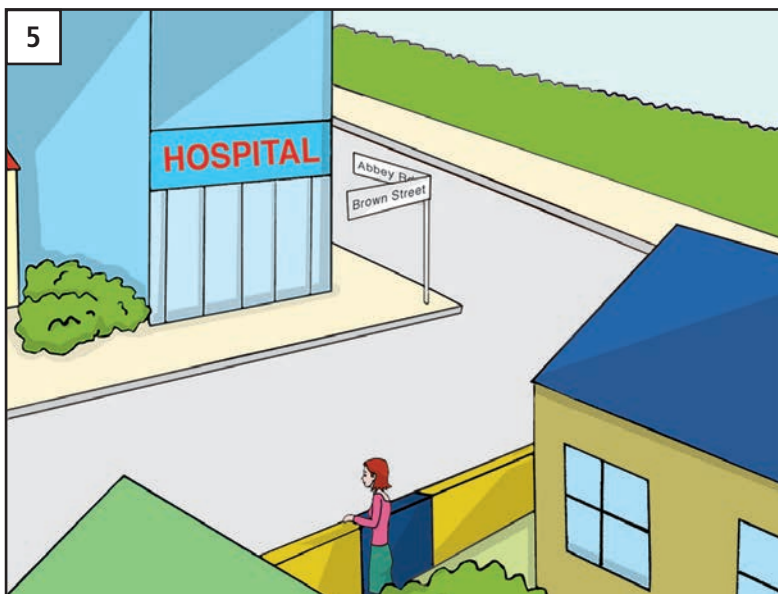
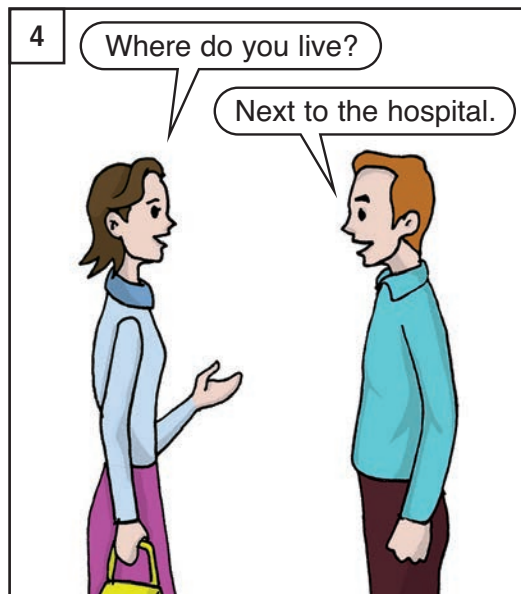
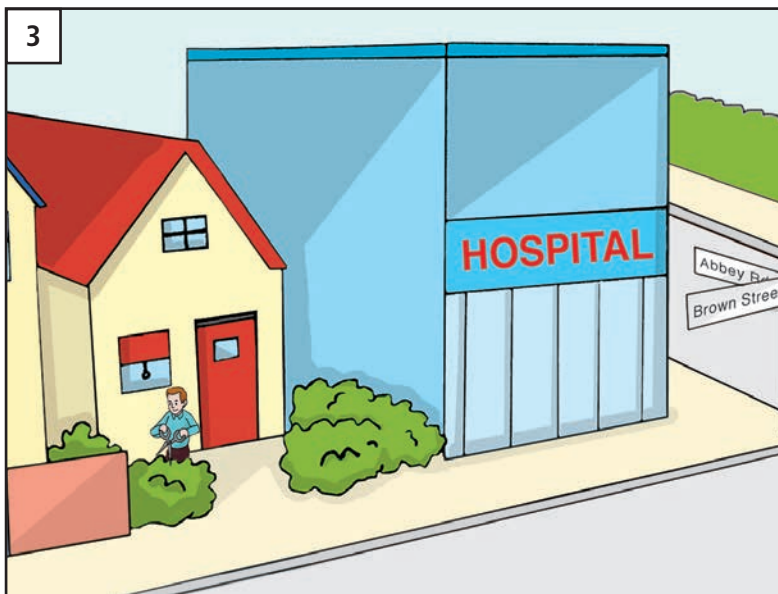
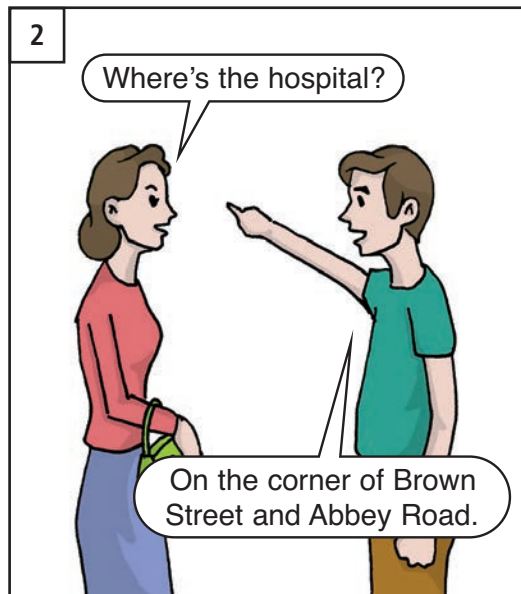
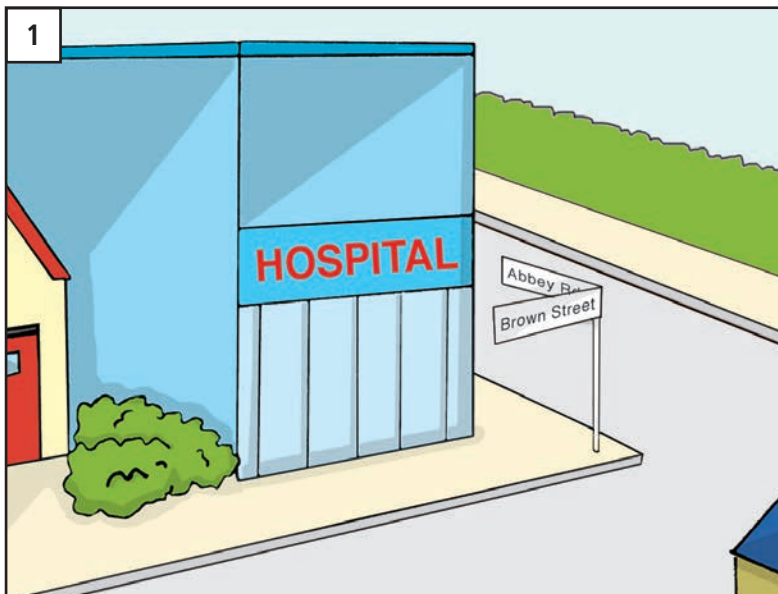

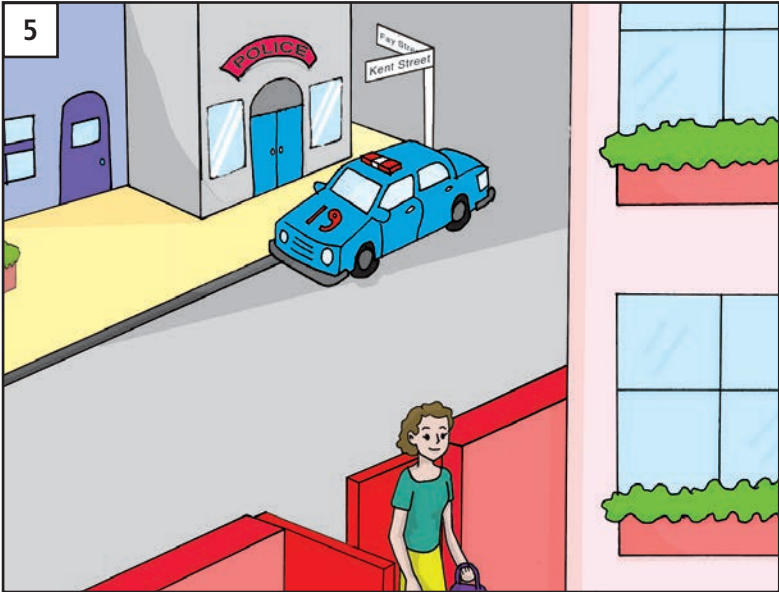
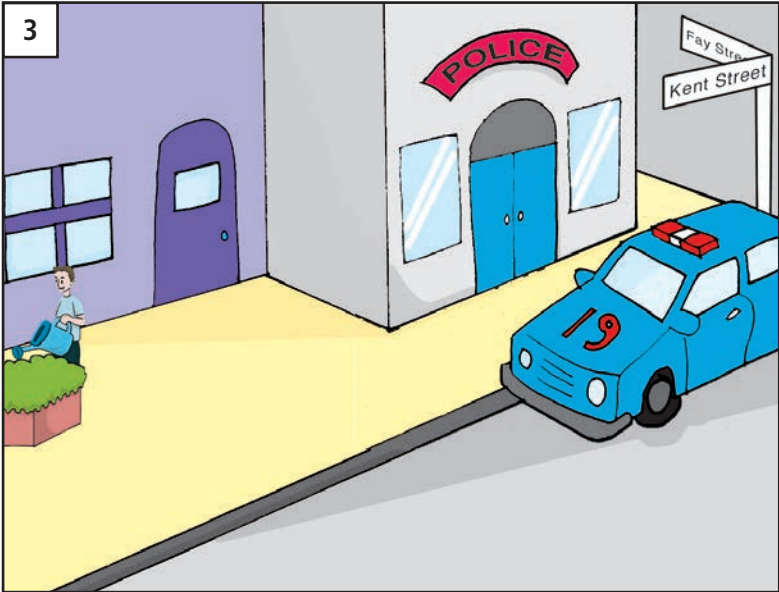
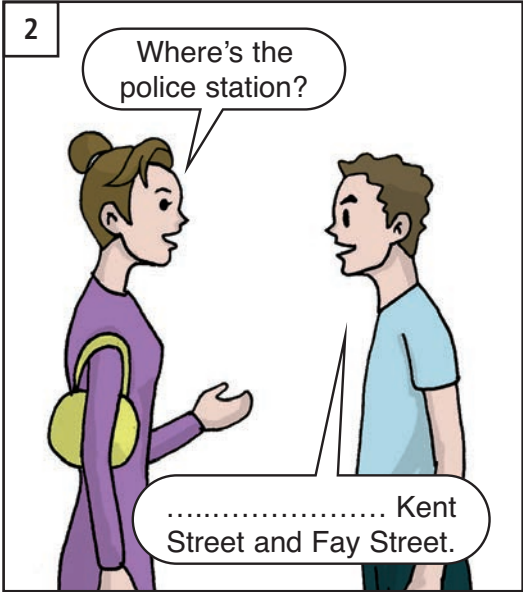
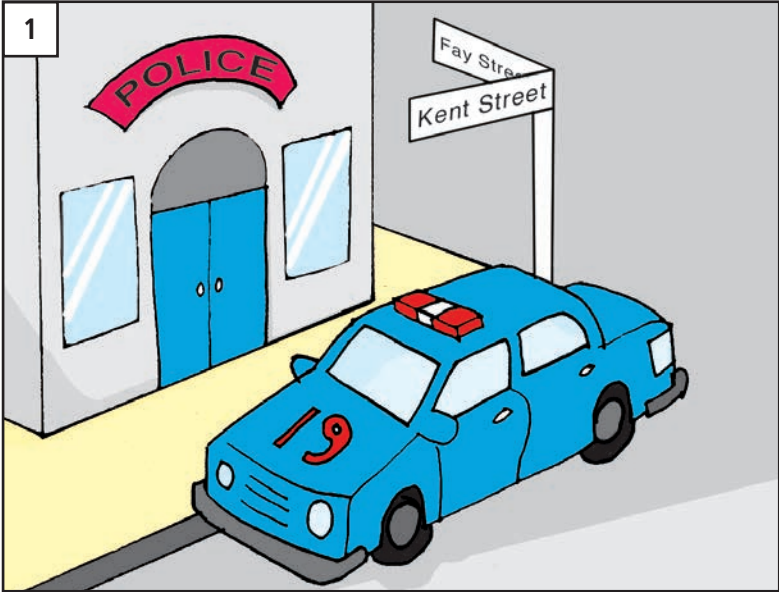

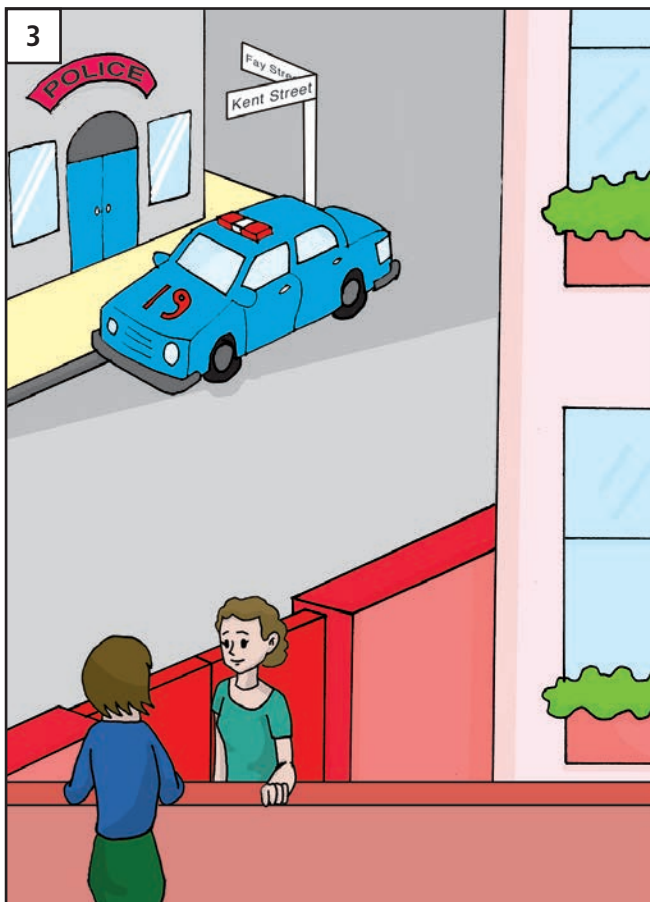

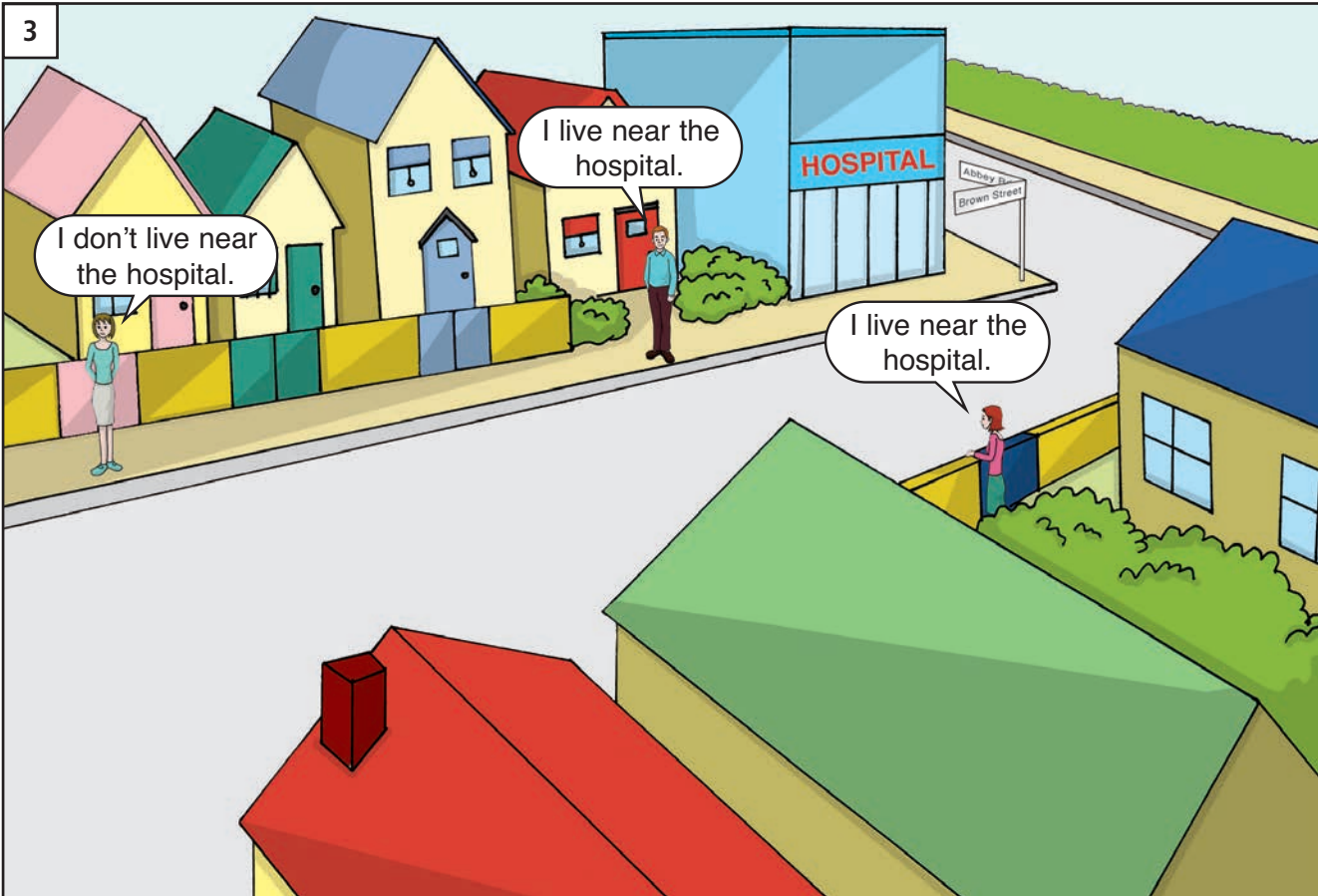
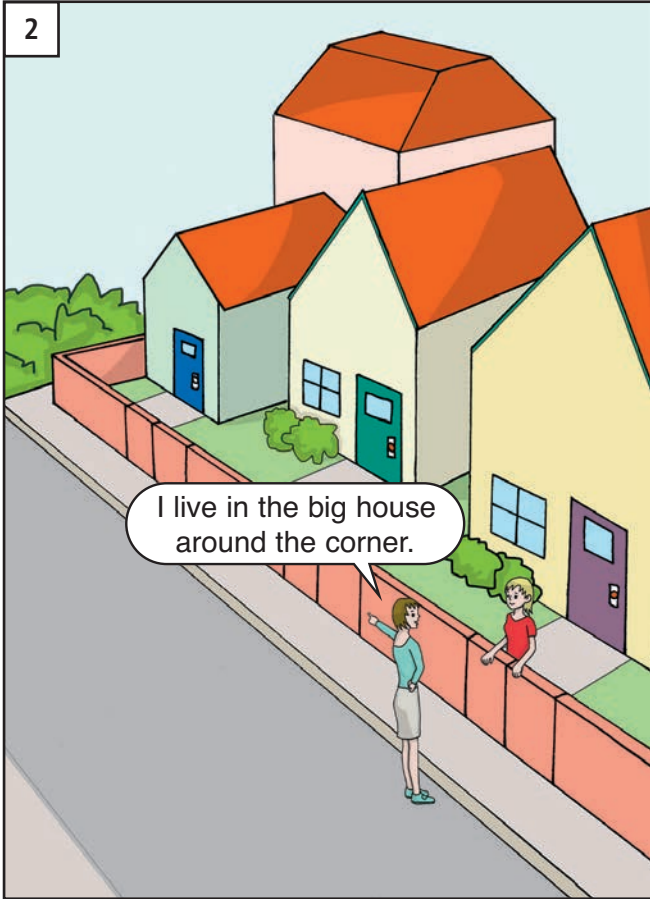
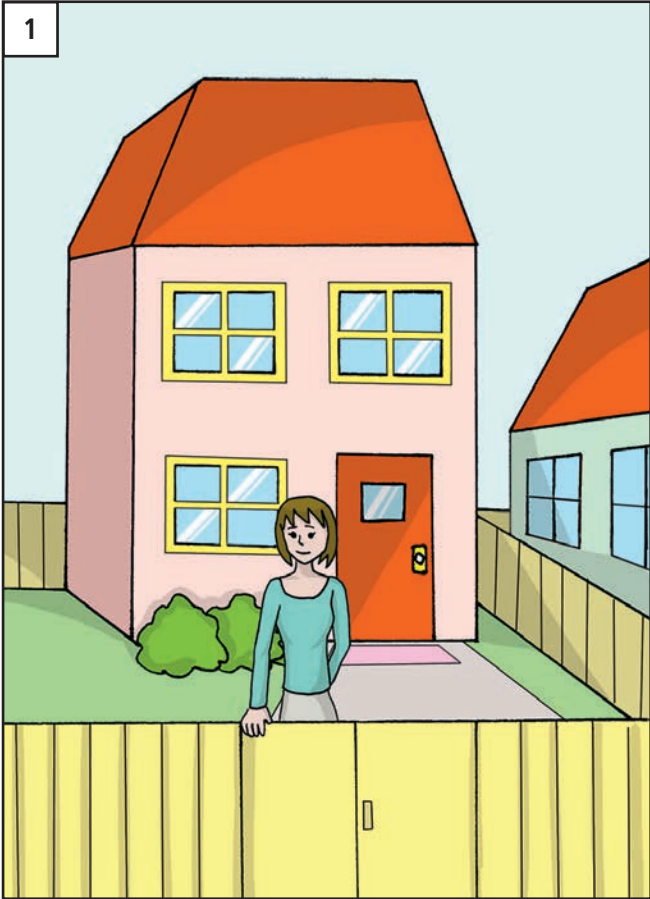



I will = I'll

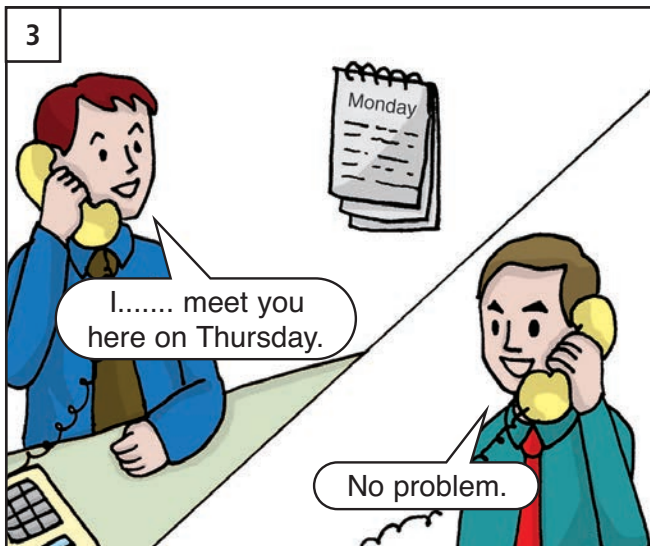

The Bensons

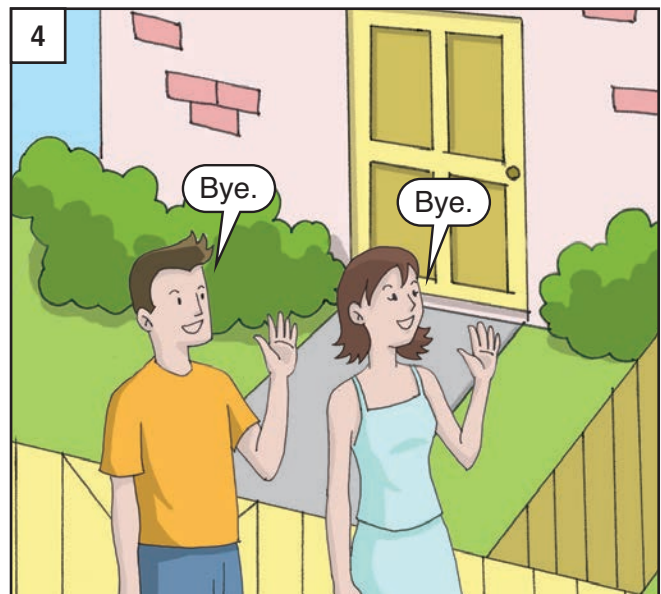
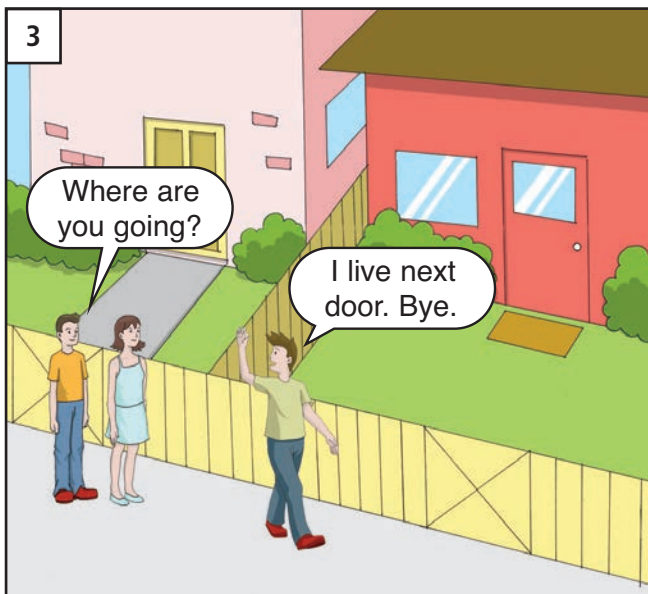
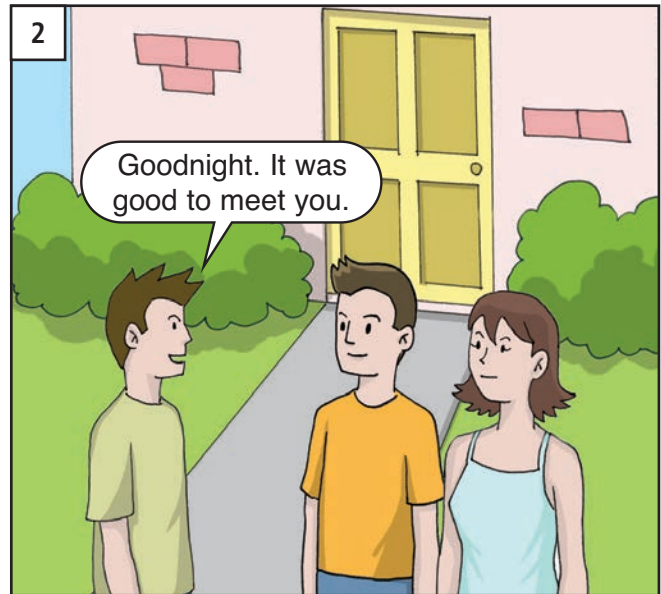
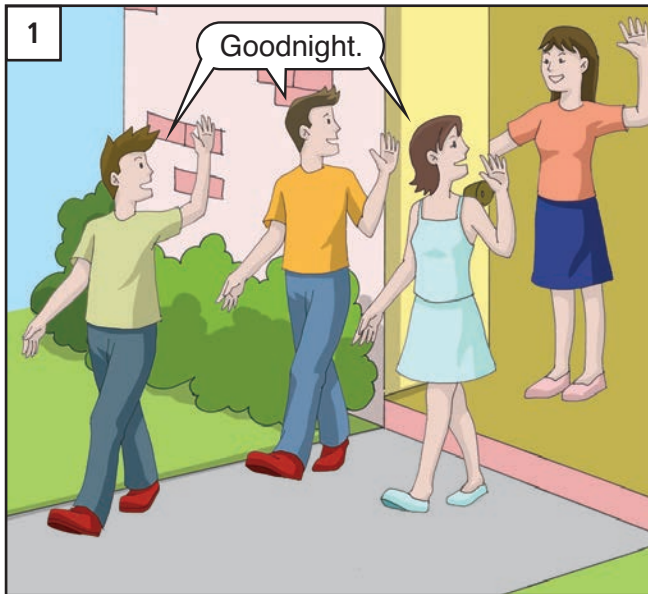

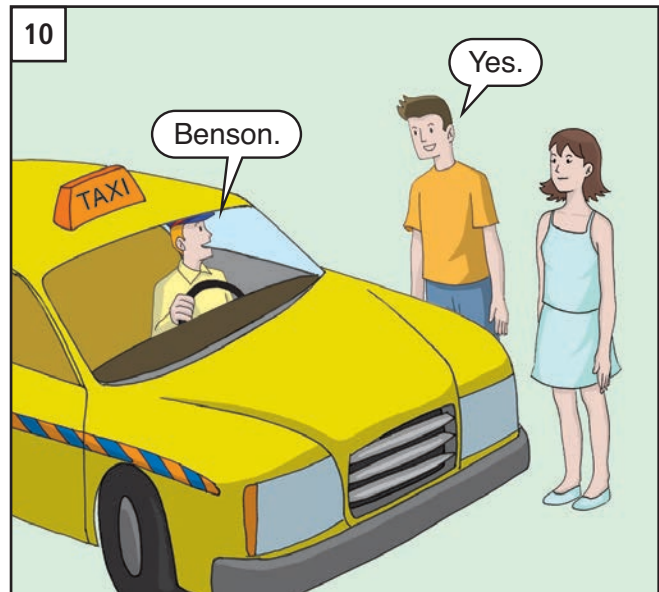
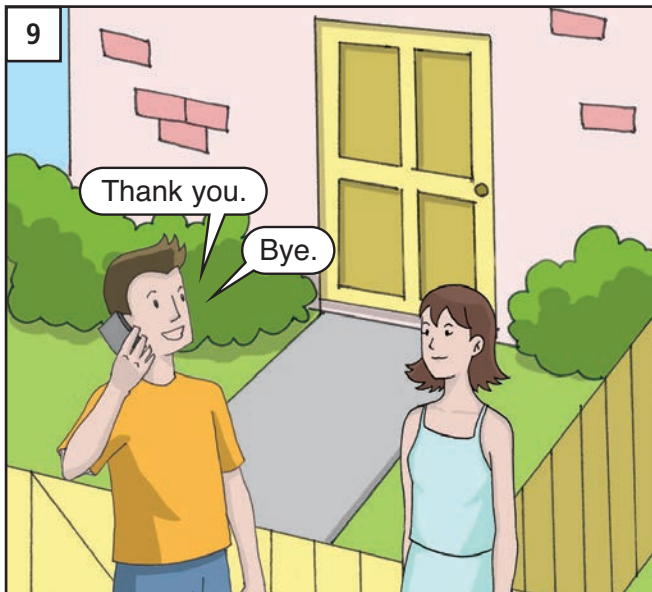
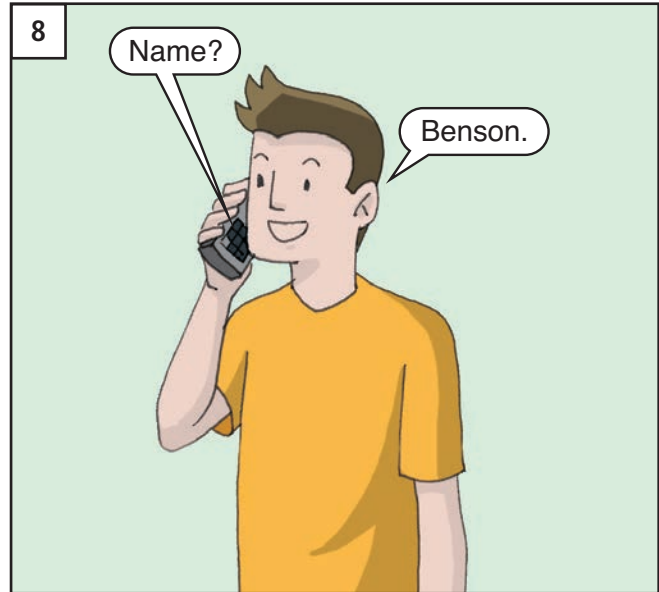
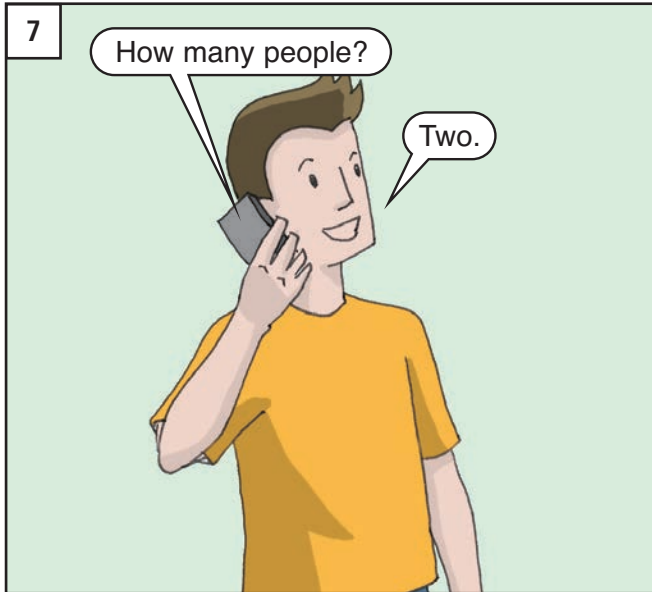

UNIT 13: How much is this purse?

Do [du:]

Do you take... ? [du: ju: teik]

Do you have... ? [du: ju: hæv]

cash [kæʃ]

credit card [kred'it ka:rd]

some [sʌm]

any [en'i:]

How's your ... now? [haʊz ju:r ... nau]

You should ... [ju: ʃu:d]

No problem. [nou pra:b'ləm]

That's okay. [ðæts oukei']

play [plei]

piano [pi:æ'nou]

guitar [gita:r']

trumpet [trʌm'pit]

violin [vaiəlin']

or [ɔ:r]

drugstore [drʌg'stɔ:r]

bag [bæg]

tube [tu:b]

carton [ka:r'tən]

box [ba:ks]

egg [eg]

toothpaste [tu:θ'peist]

toothbrush [tu:θ'brʌʃ]

window [win'dou]

door [dɔ:r]

floor [flɔ:r]

ceiling [si:'liŋ]

wall [wɔ:l]

room [ru:m]

waiting room [wei'tiŋ ru:m]

make [meik]

need [ni:d]

wait [weit]

old [ould]

new [nu:]

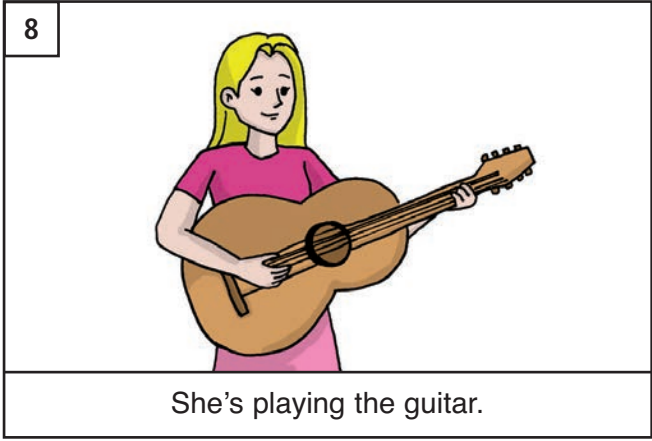
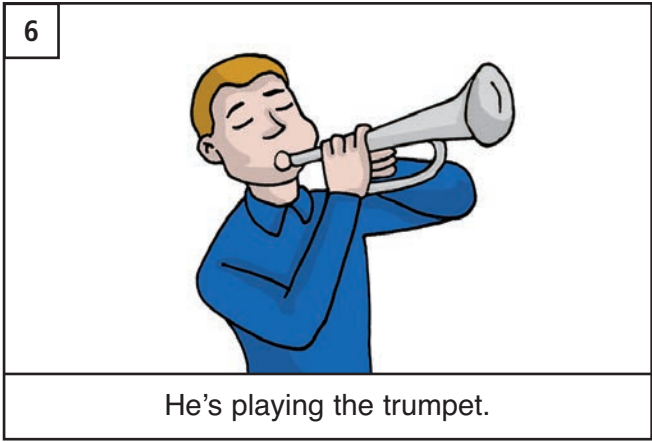
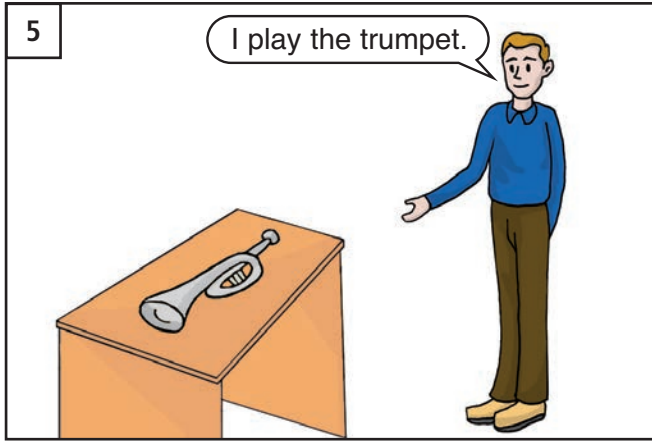
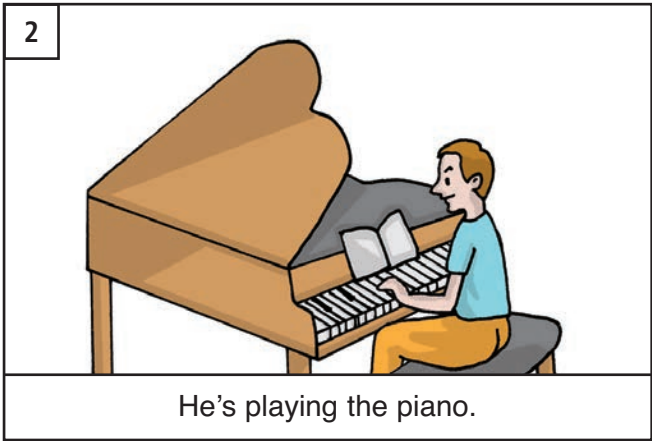

UNIT 13

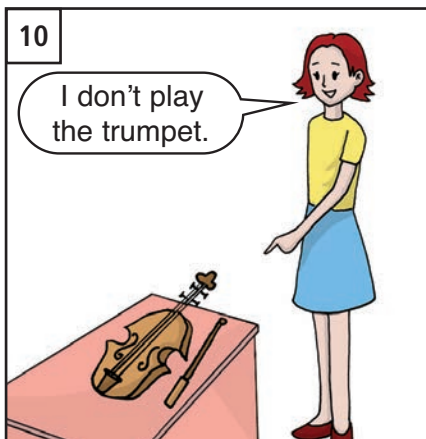
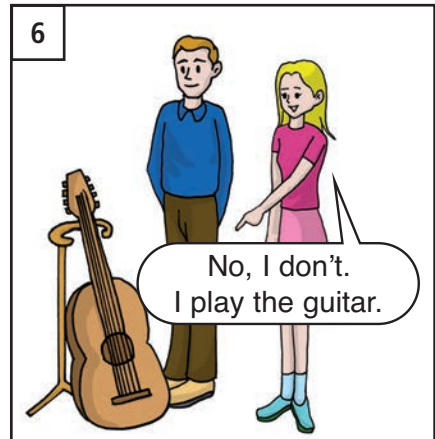
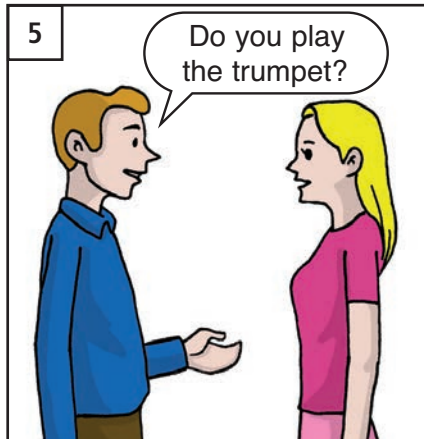
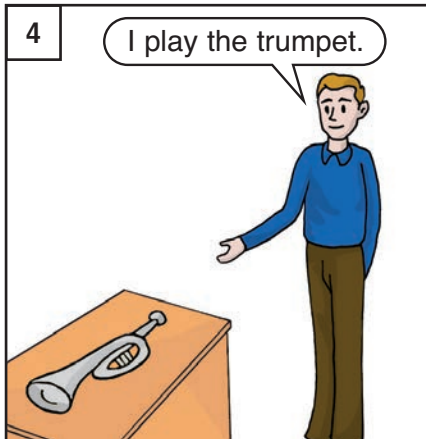

How much is this purse?

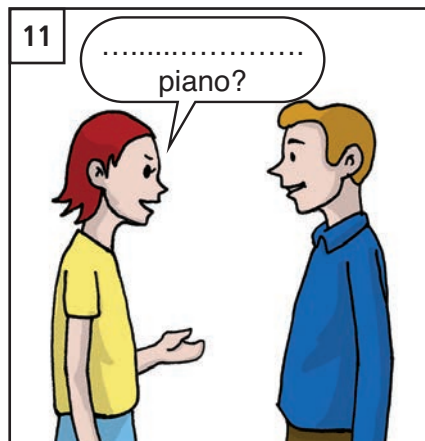
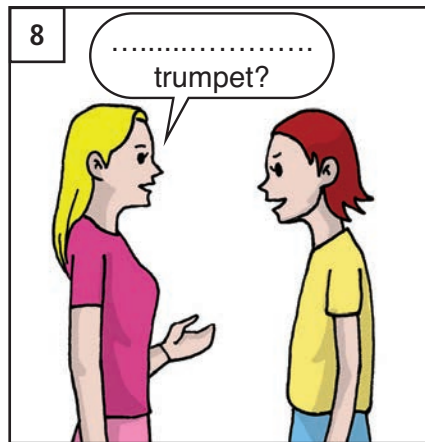
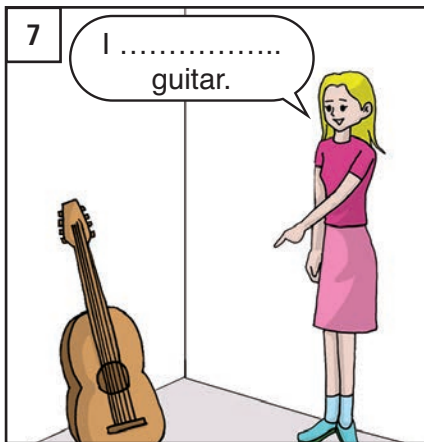
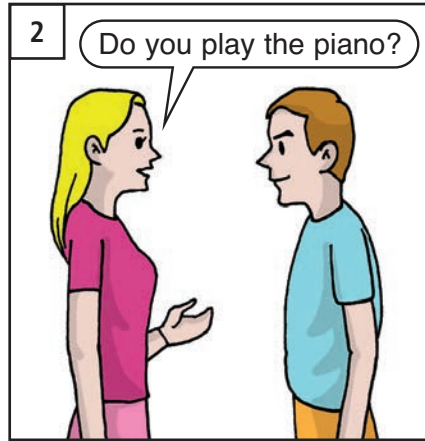
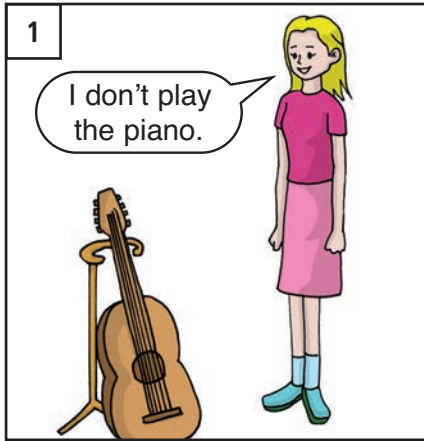

UNIT 13

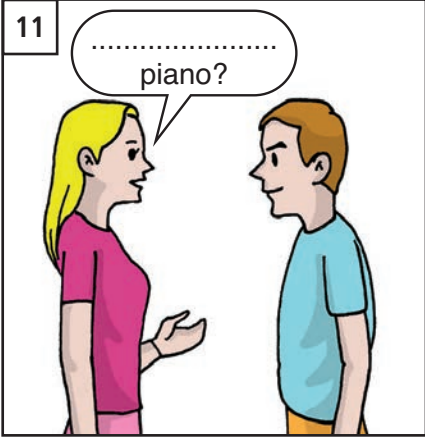
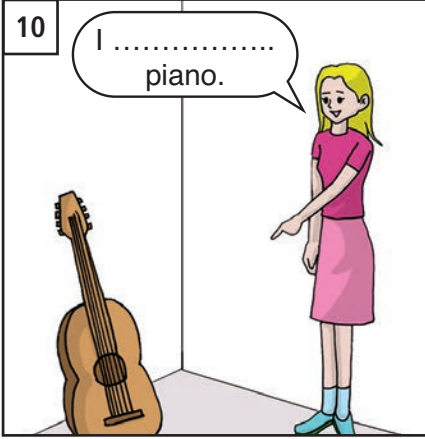
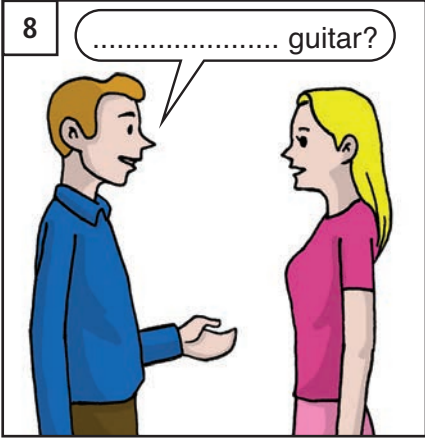
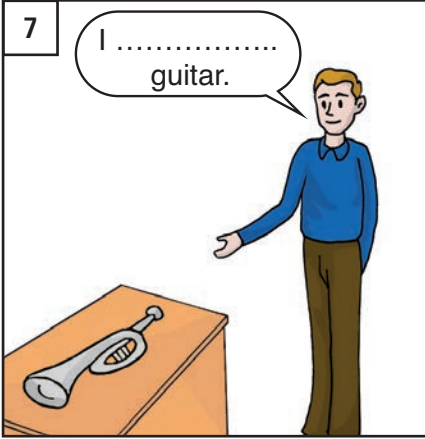
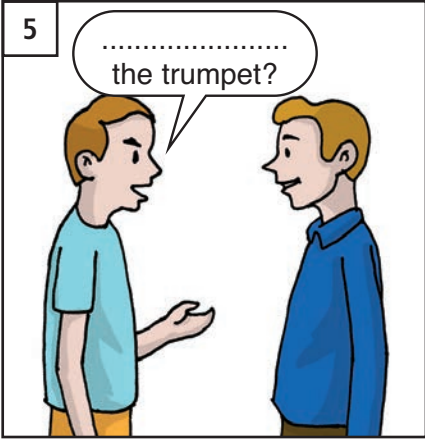
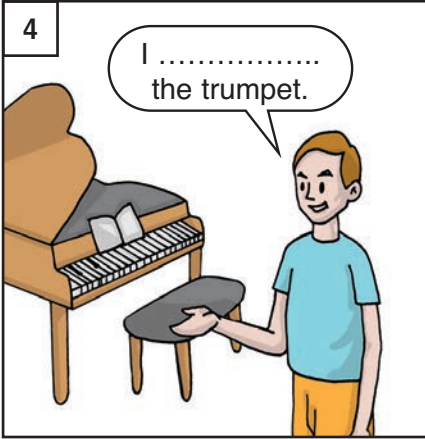
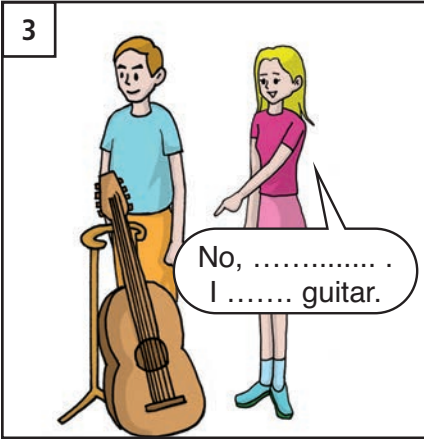
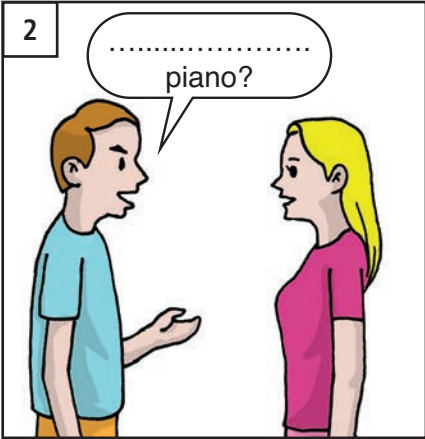

How much is this purse?

1



an old car

2



a new car

3



He needs a new car.

4



an old pair of shoes

5



a new pair of shoes

6



He needs a new pair of shoes.

7

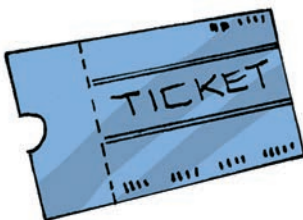

a ticket

8



UNIT 13

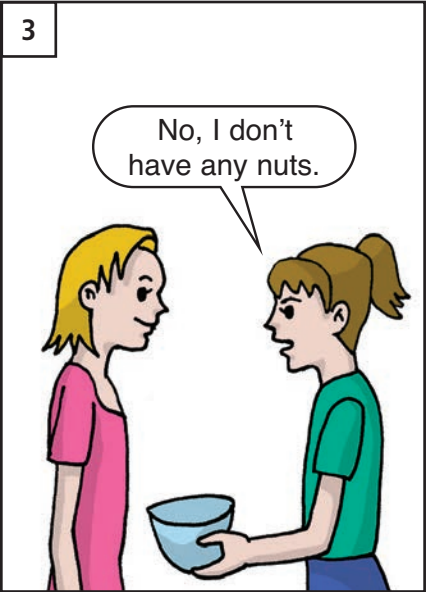
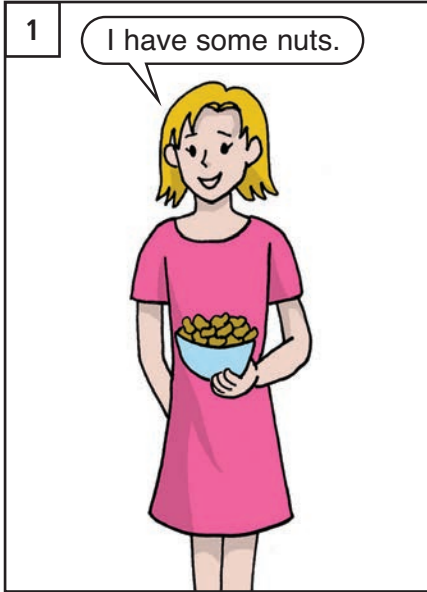

How much is this purse?

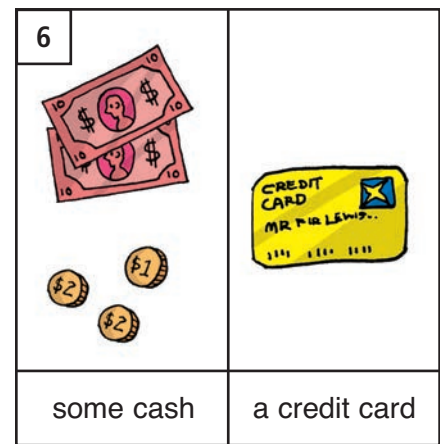

UNIT 13

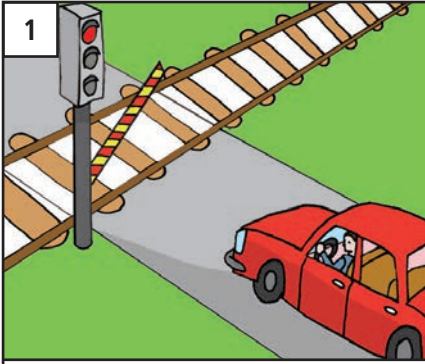

stop

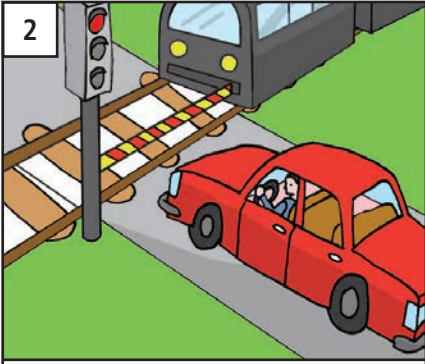

wait

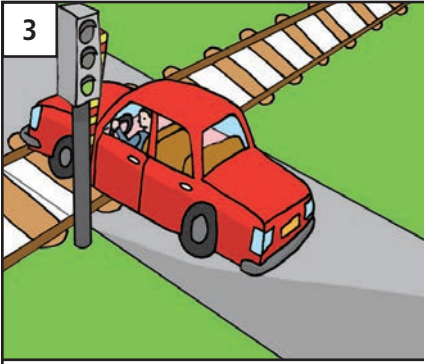

go

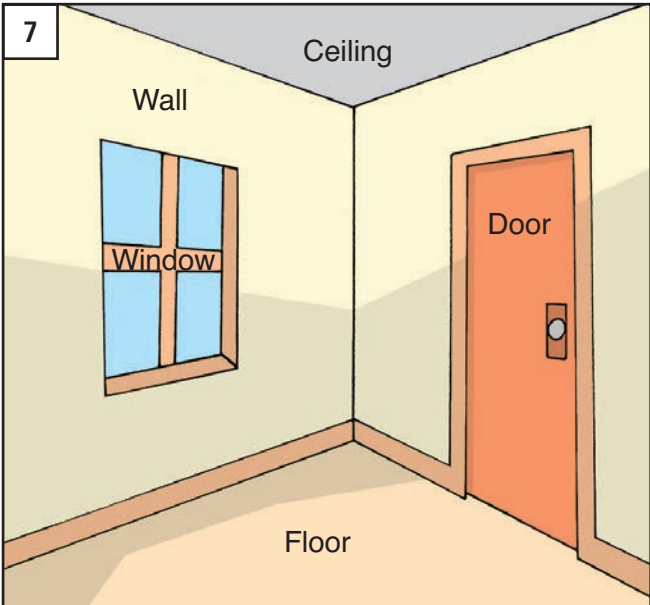

a room

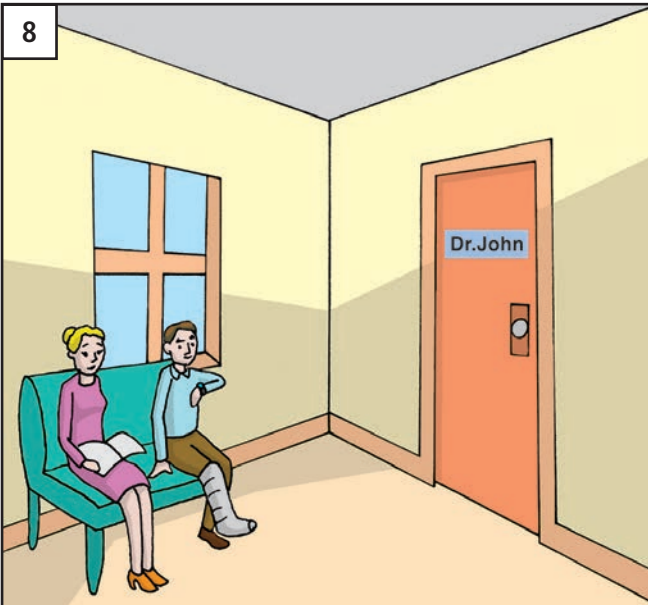

a waiting room

 how is = how's

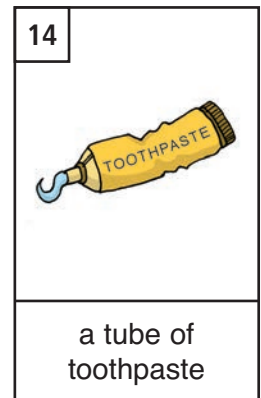
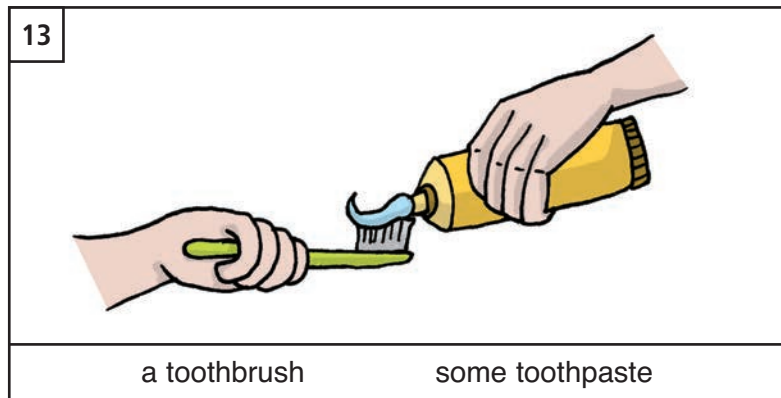
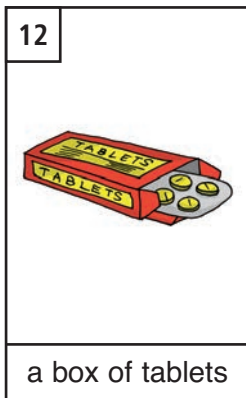
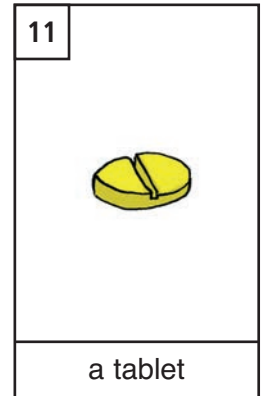
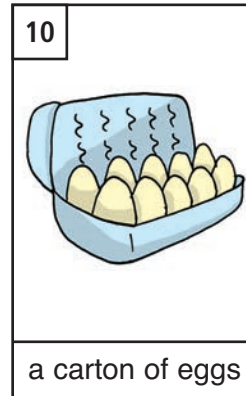
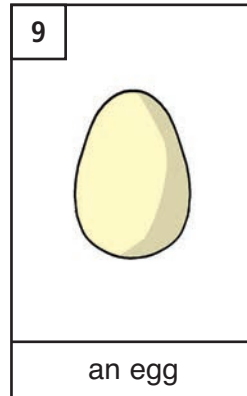
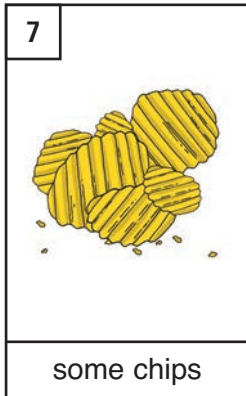
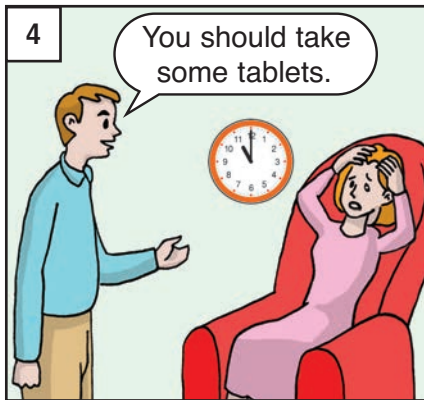
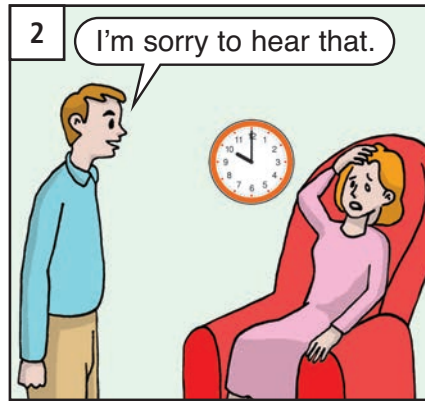
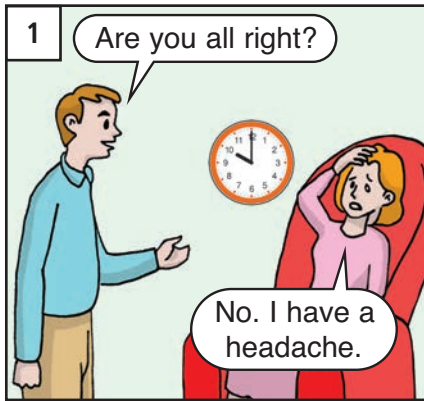

The Bensons

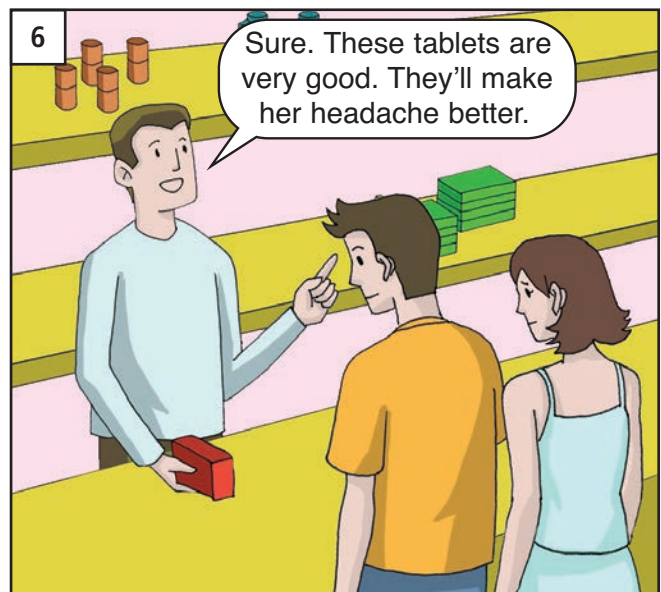
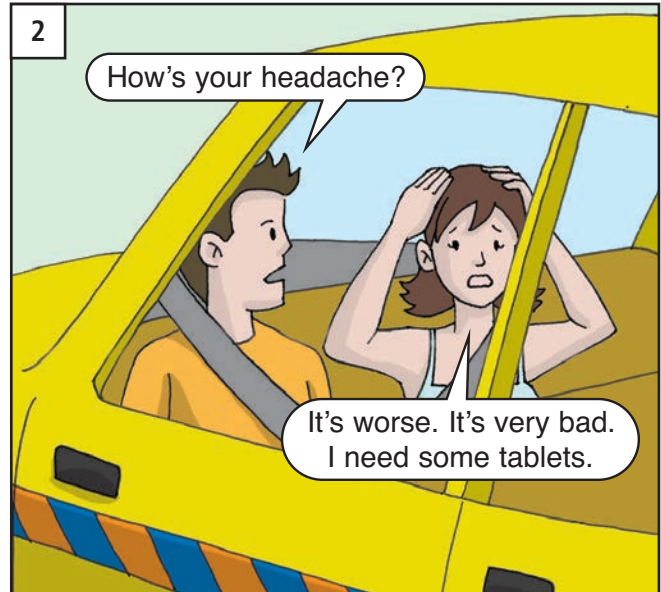
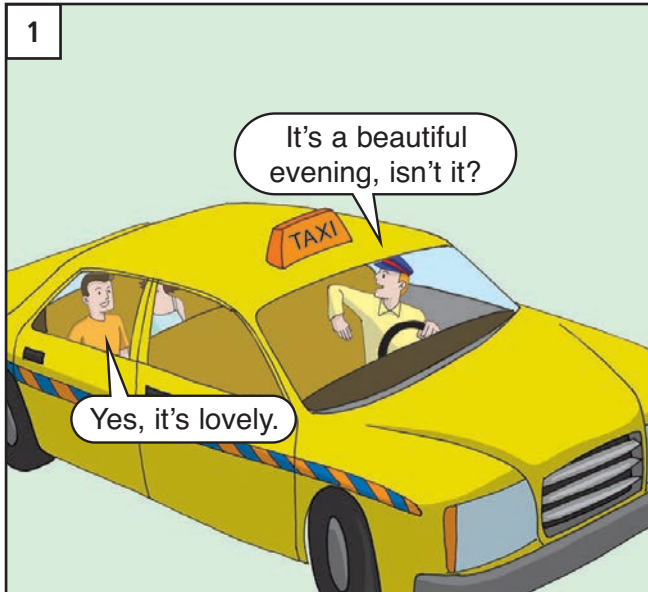

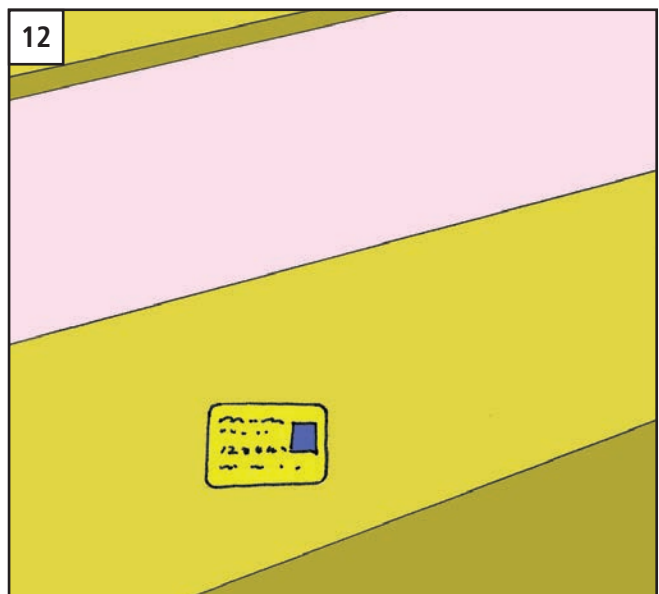
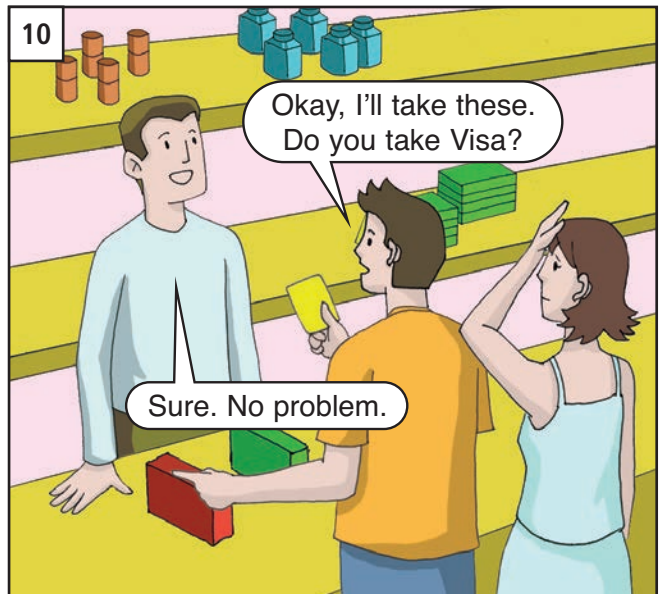
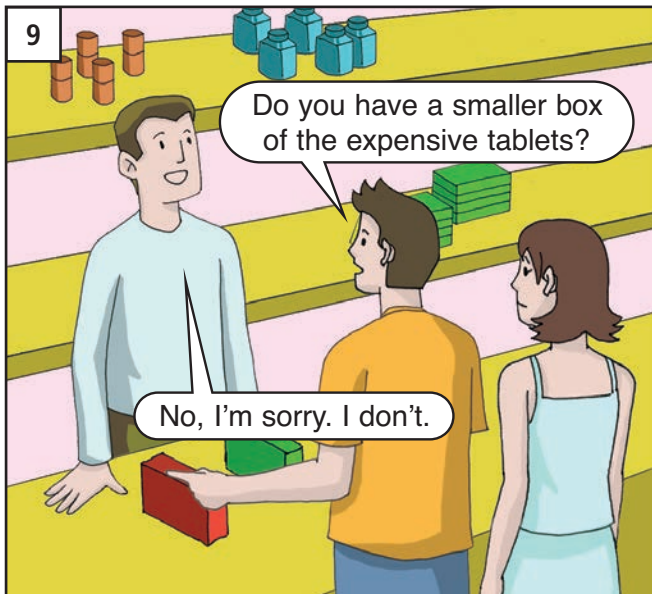
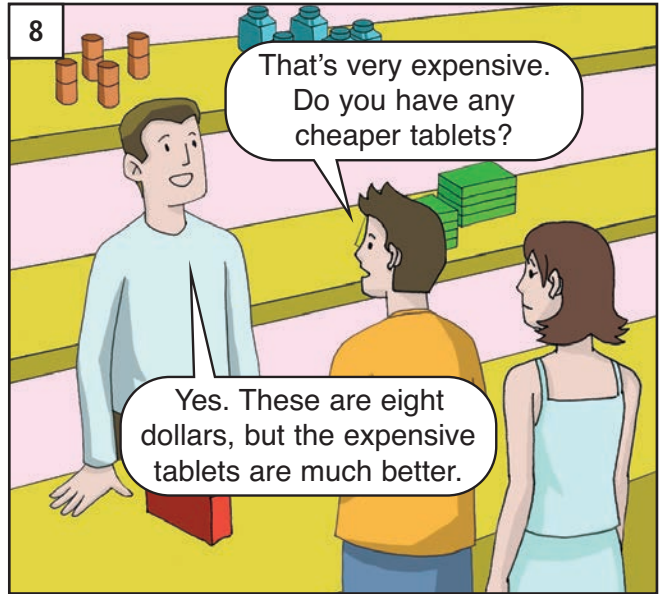
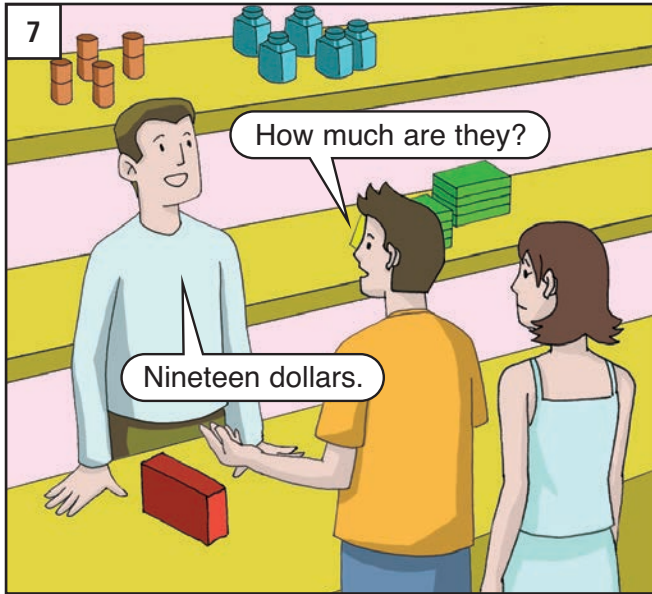

UNIT 14: It's the second street on the left.

left [left]
right [rait]
straight ahead [streit əhed']
turn [tə:rn]

before [bifə:r']
past [pæst]
with [wiθ]

bank [bæŋk]
bus stop [bʌs stɑ:p]
cinema [sin'əmə]
car park [ka:r pɑ:rk]
taxi rank [tæksi: ræŋk]
post office [poust ɔ:f'is]
gas station [gæs stei'ʃən]
railway station [reil'wei stei'ʃən]
supermarket [su:'pə:rmɑ:rkɪt]
stadium [stei'di:əm]
traffic lights [træf'ik laits]
toilet [tɔɪ'lɪt]

first [fɜ:rst]
second [sek'ənd]
third [θɜ:rd]
fourth [fɔ:rθ]
fifth [fɪfθ]
sixth [sɪksθ]
seventh [sev'ənθ]
eighth [eɪtθ]
ninth [naɪnθ]
tenth [tenθ]

red [red]
yellow [jel'ou]
blue [blu:]
green [gri:n]
white [waɪt]
black [blæk]
orange [ɔ:r'ɪndʒ]
brown [braʊn]

fence [fens]
roof [ru:f]

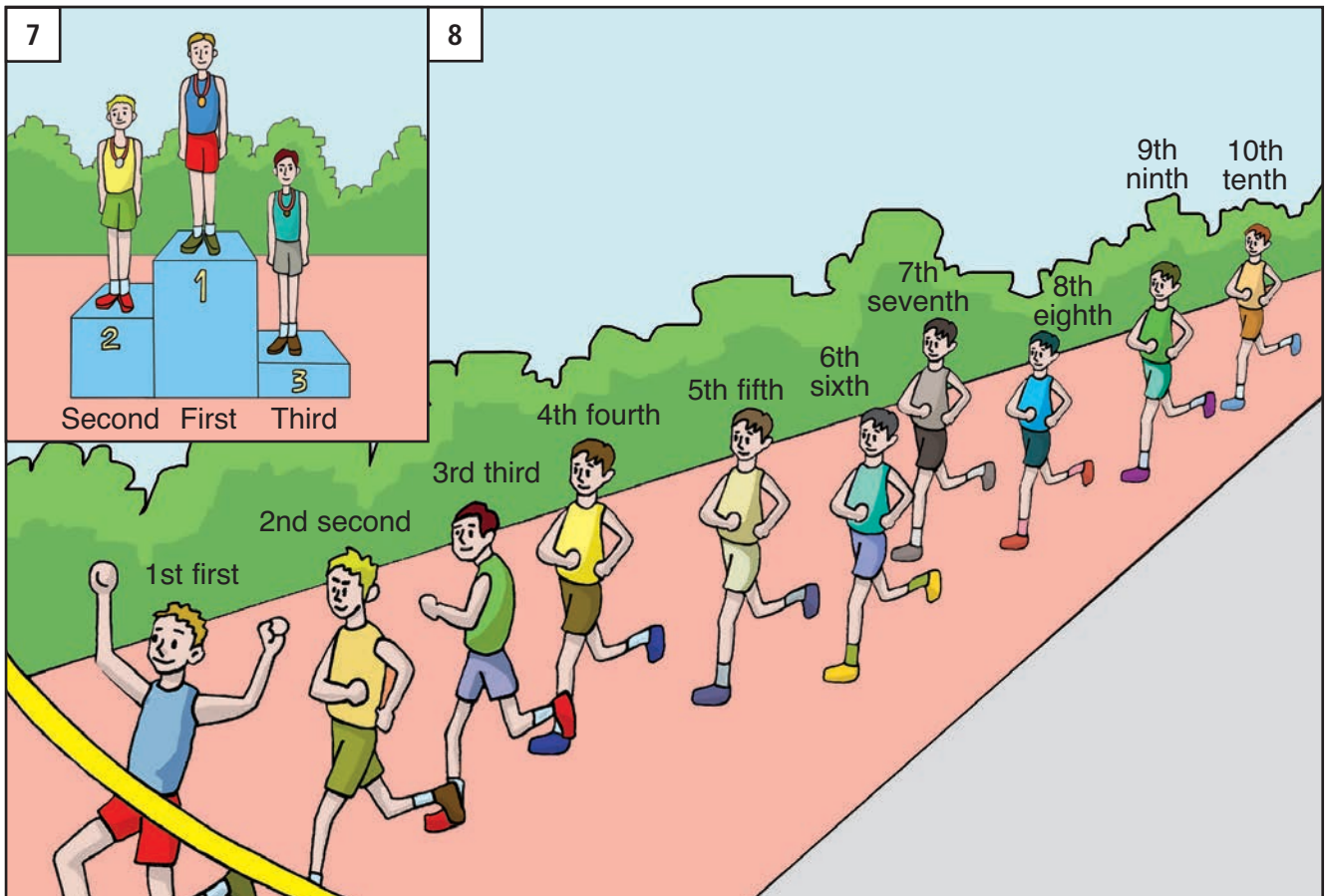
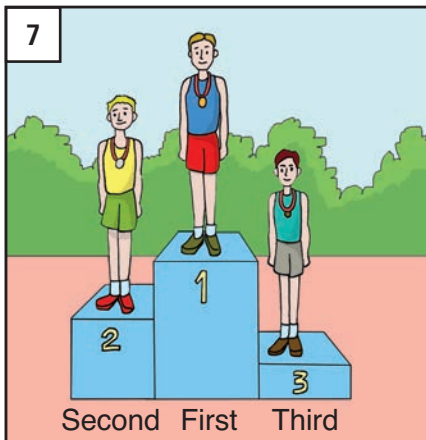
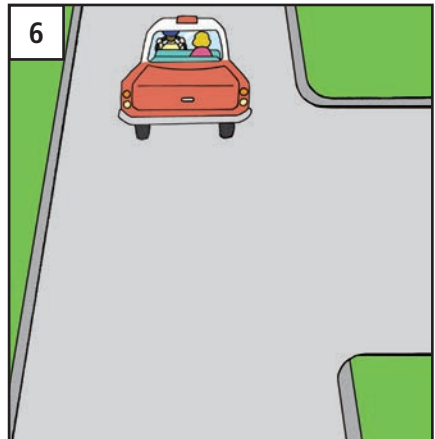
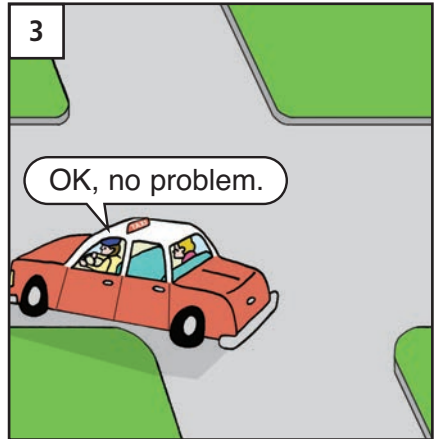
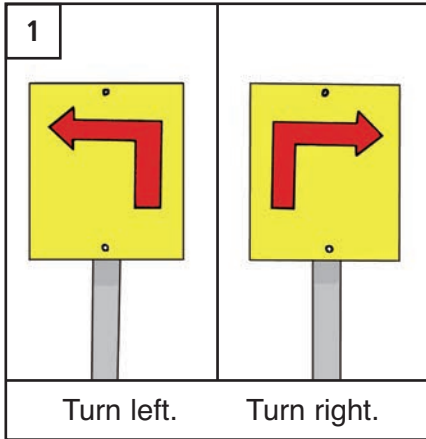

UNIT 14

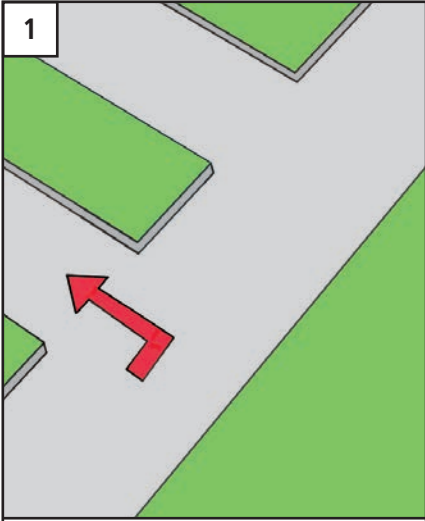

first street on the left

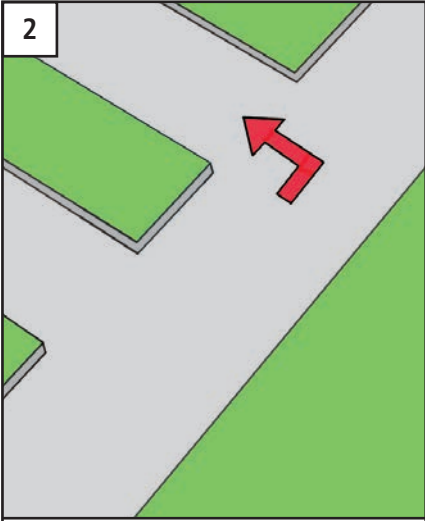

second street on the left

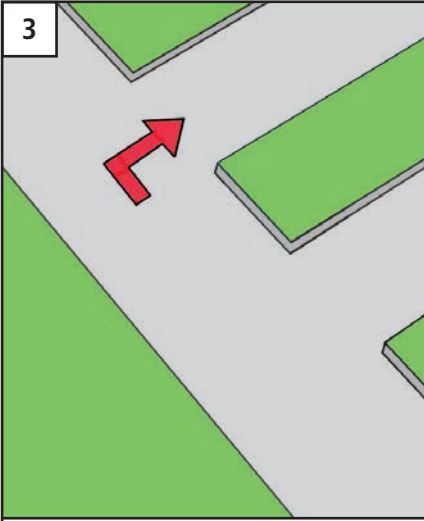

second street on the right

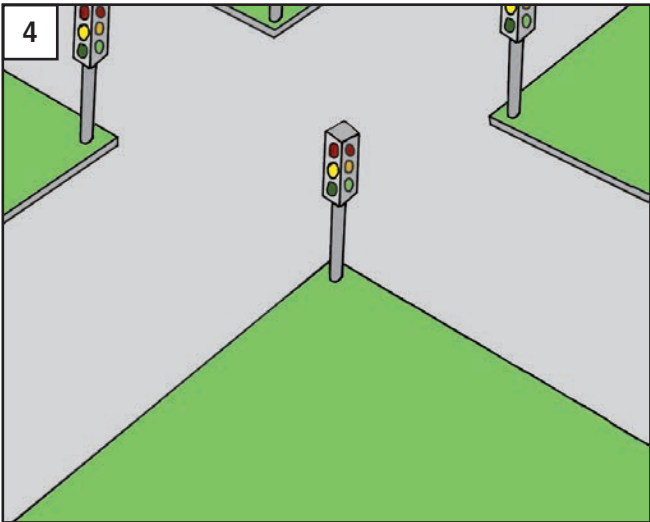

traffic lights

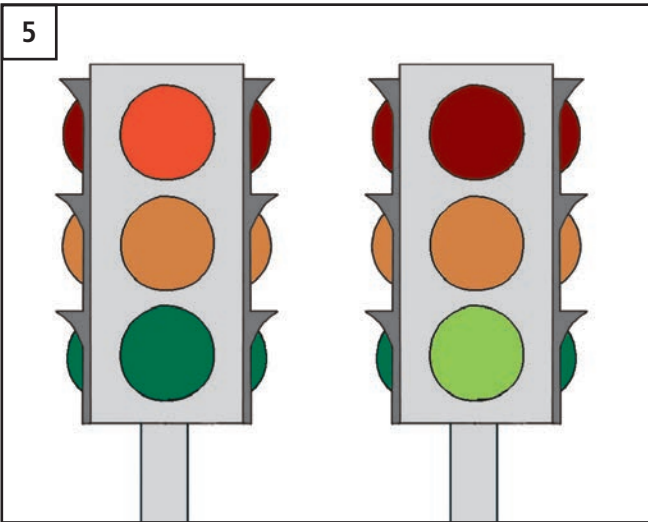

stop

go

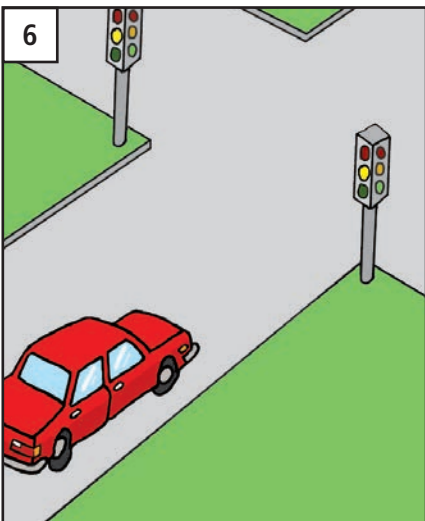

before the traffic lights

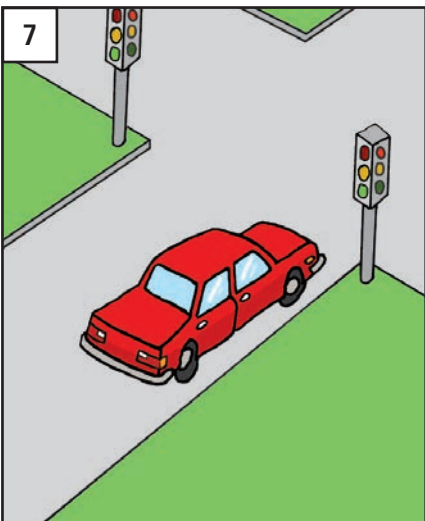

at the traffic lights

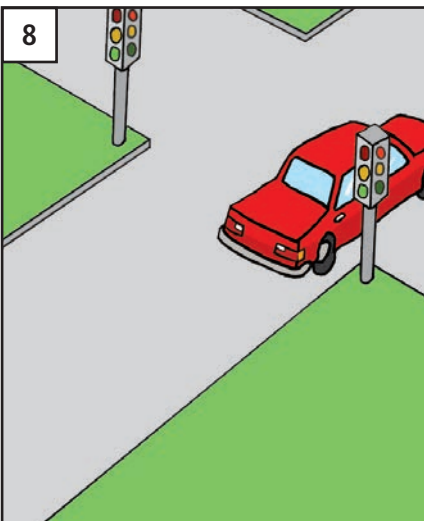

past the traffic lights

It's the second street on the left.

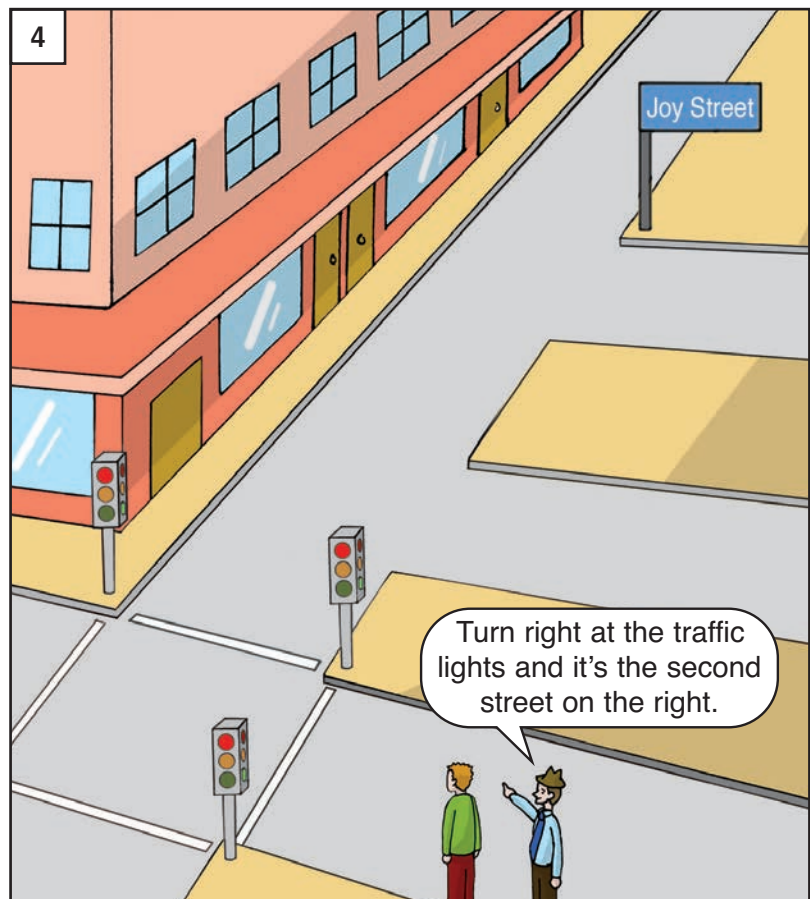
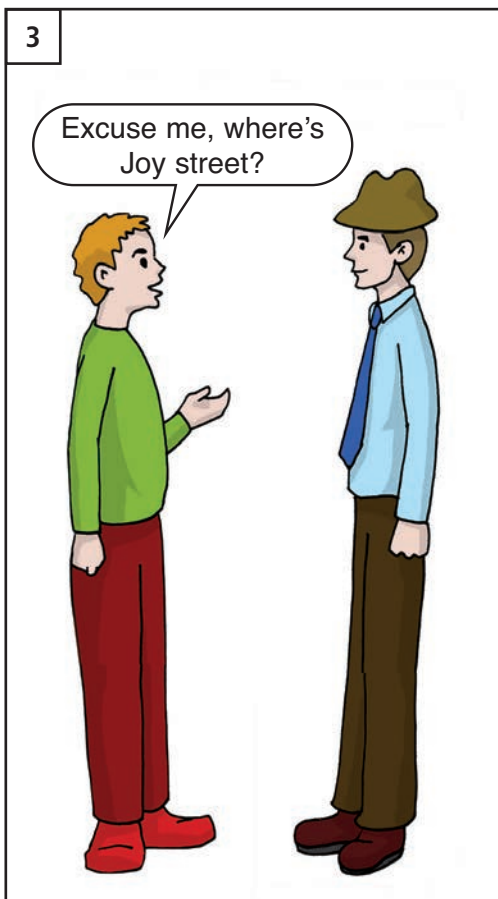
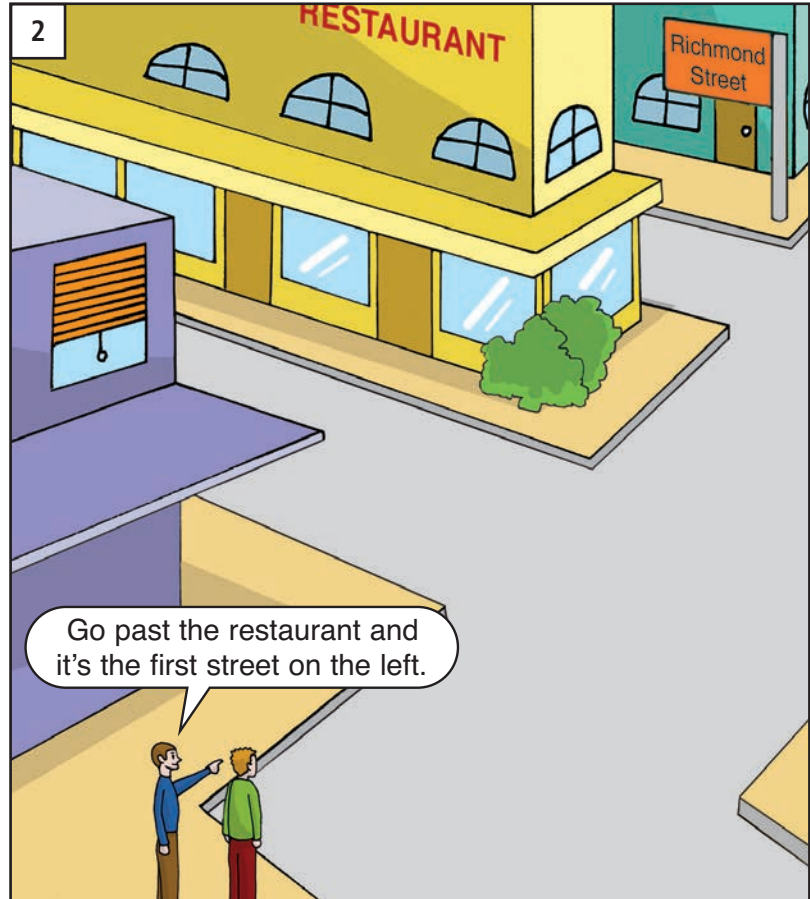
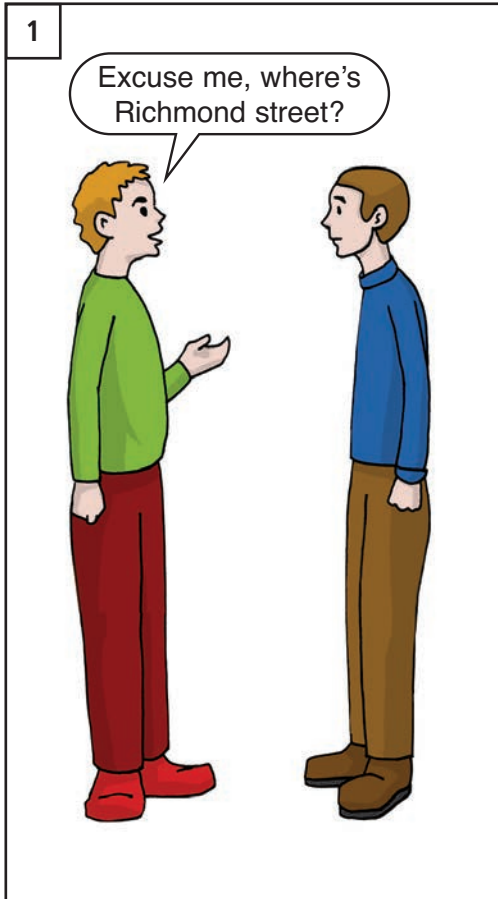

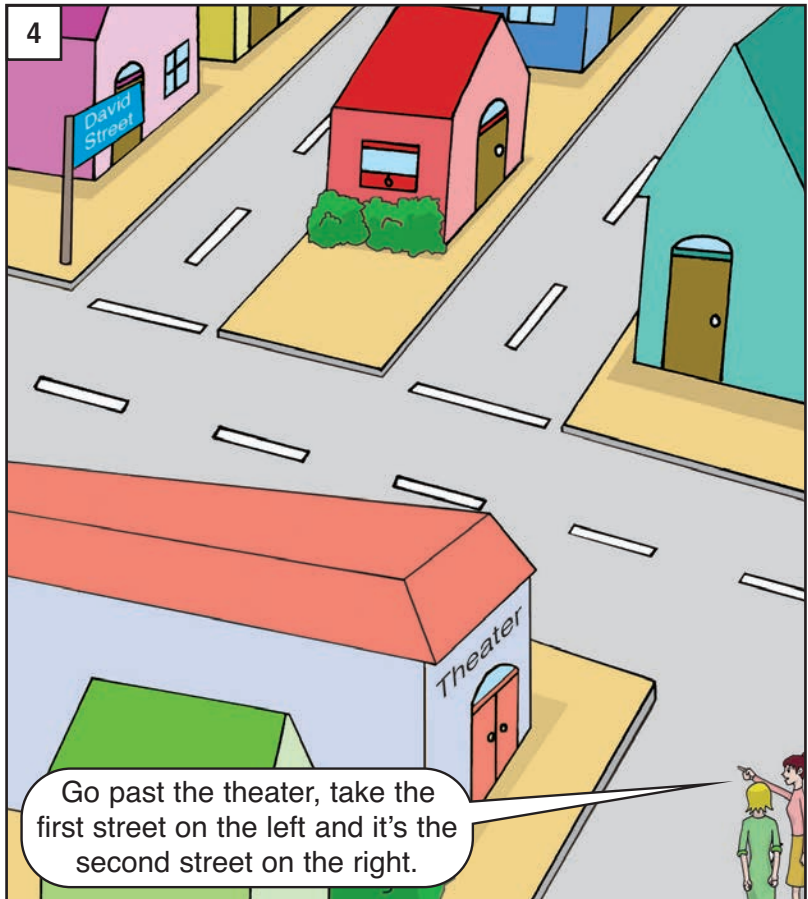
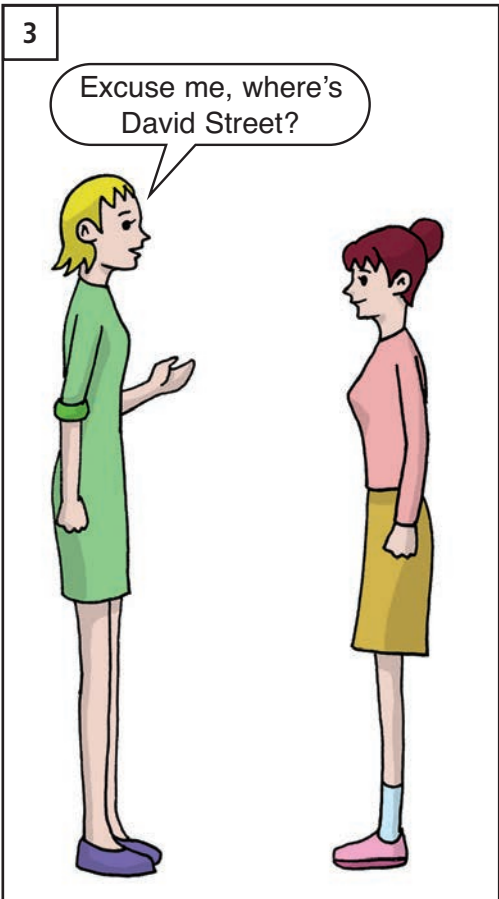
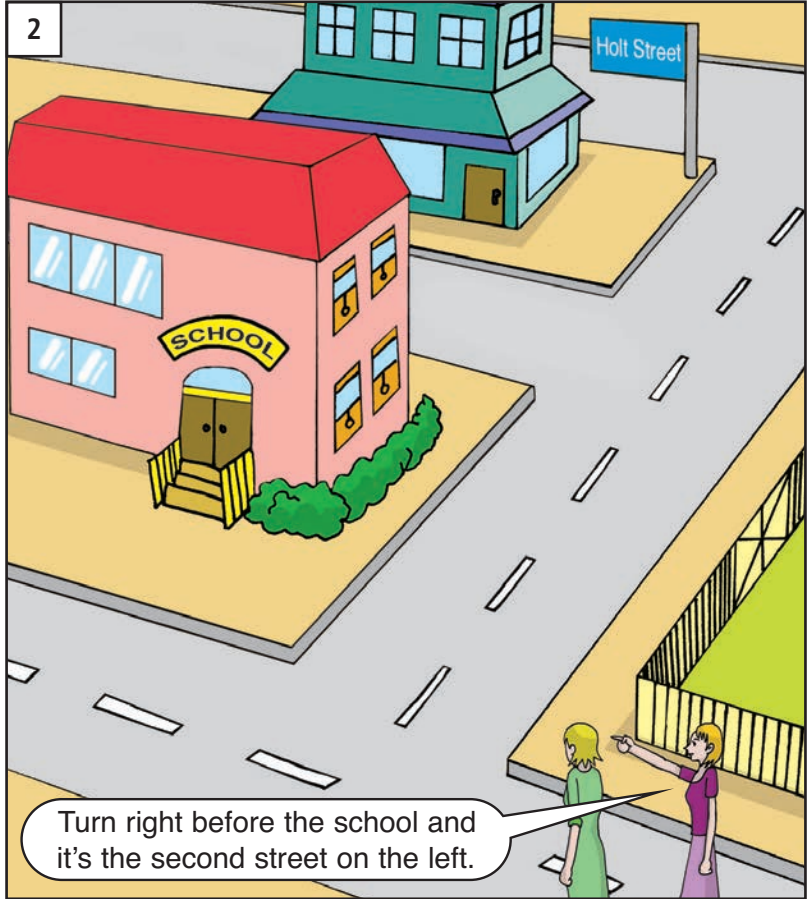
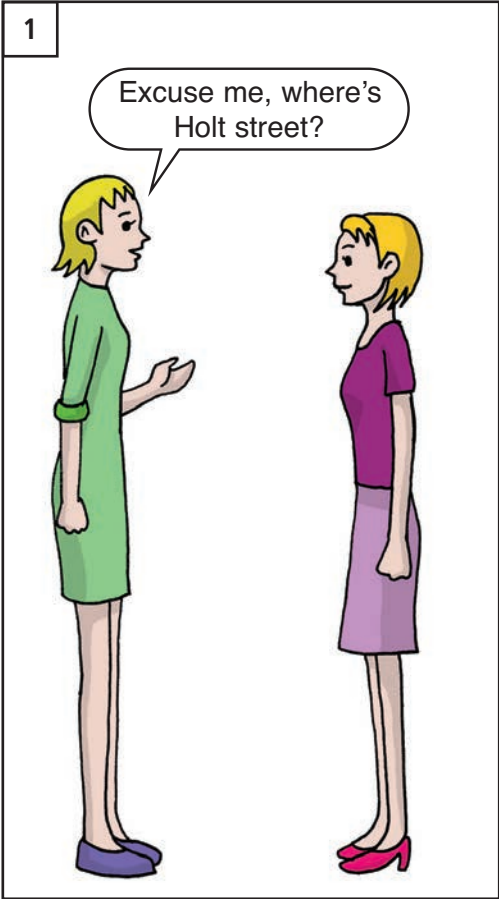

It's the second street on the left.

Excuse me, where's the...?

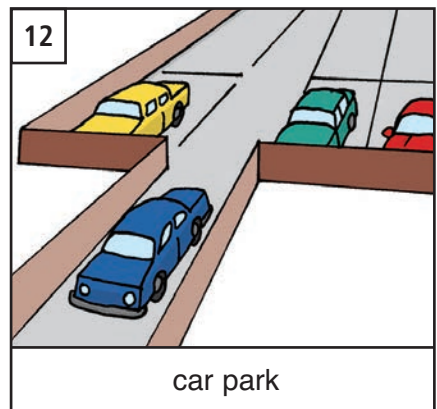
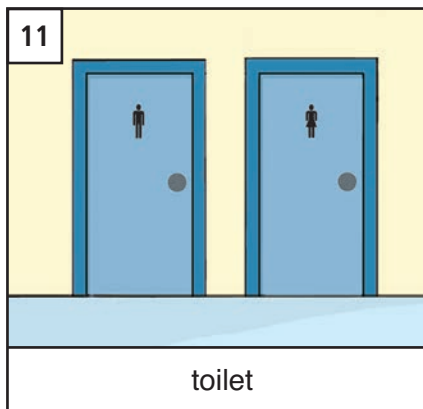
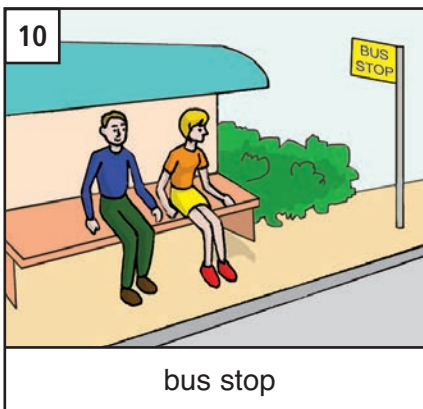
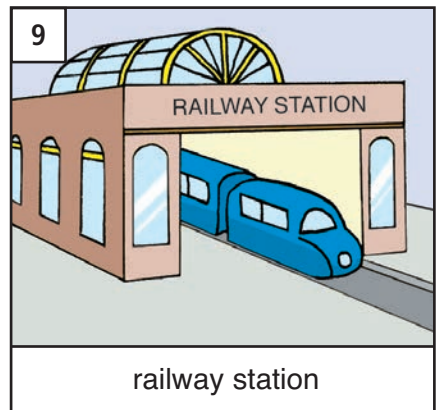
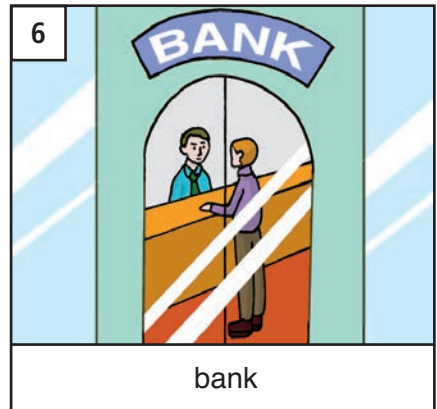
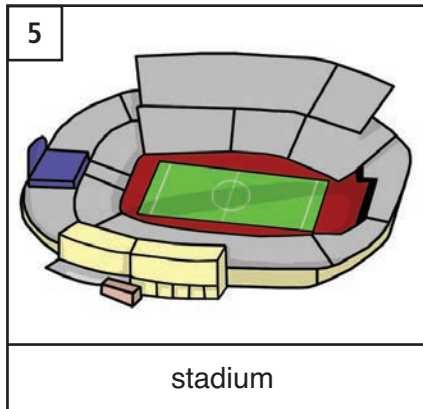
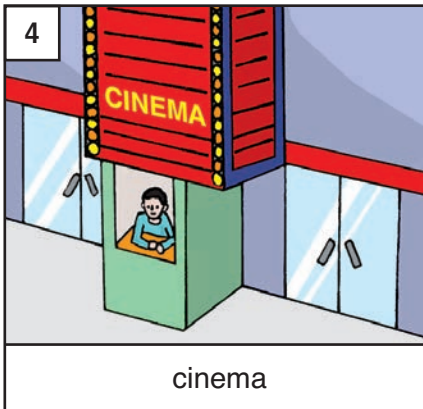
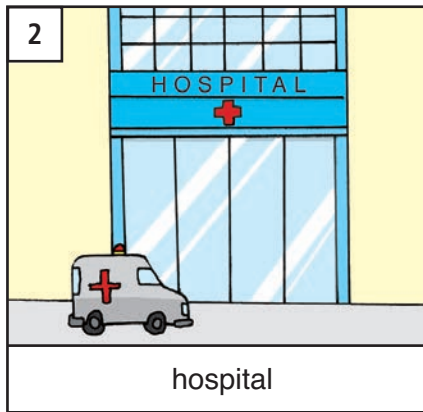
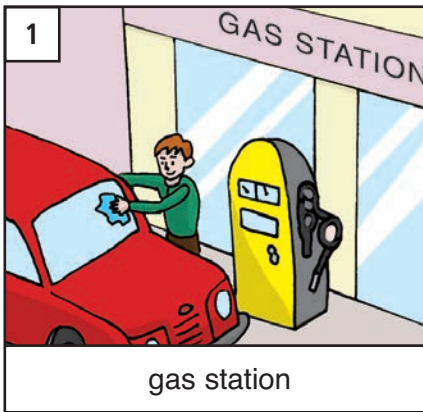

UNIT 14

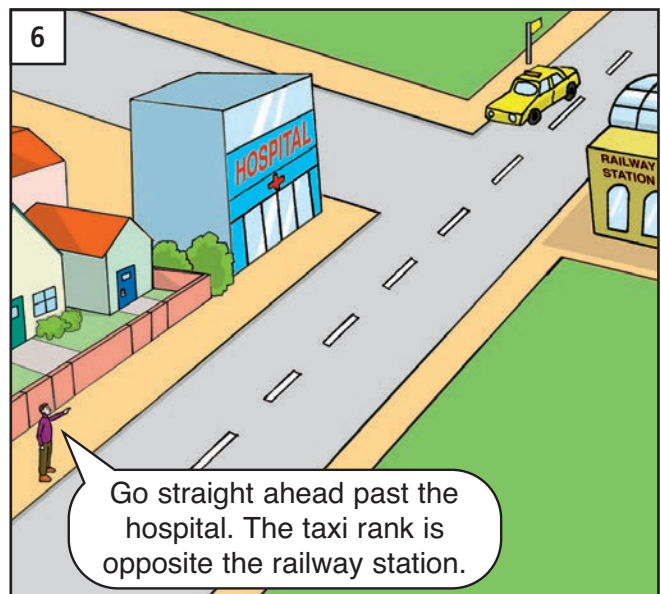
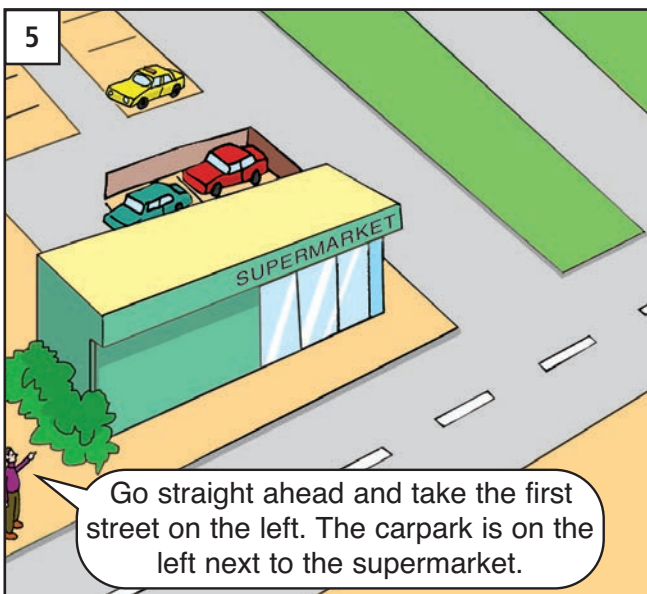
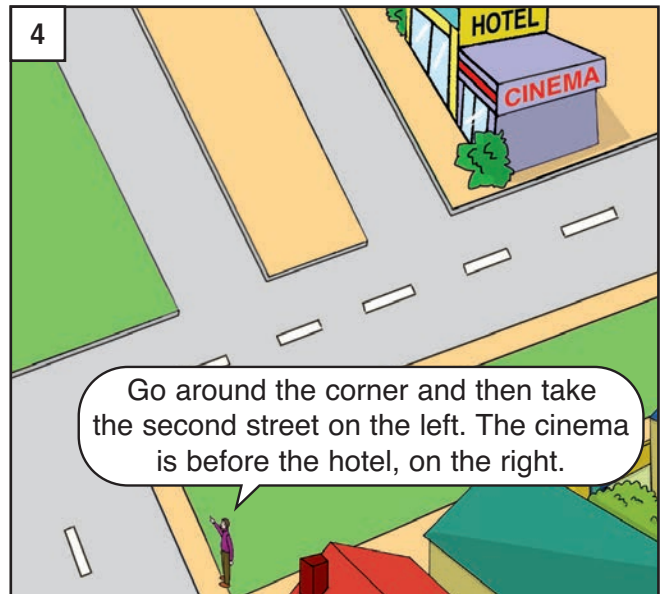
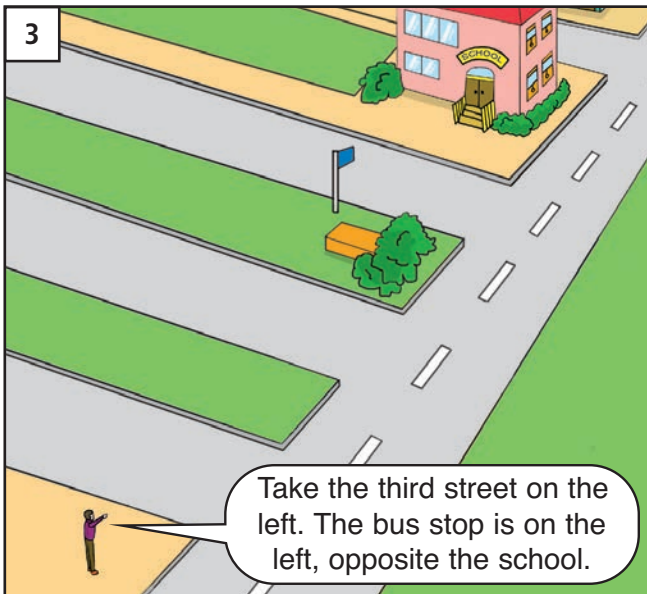
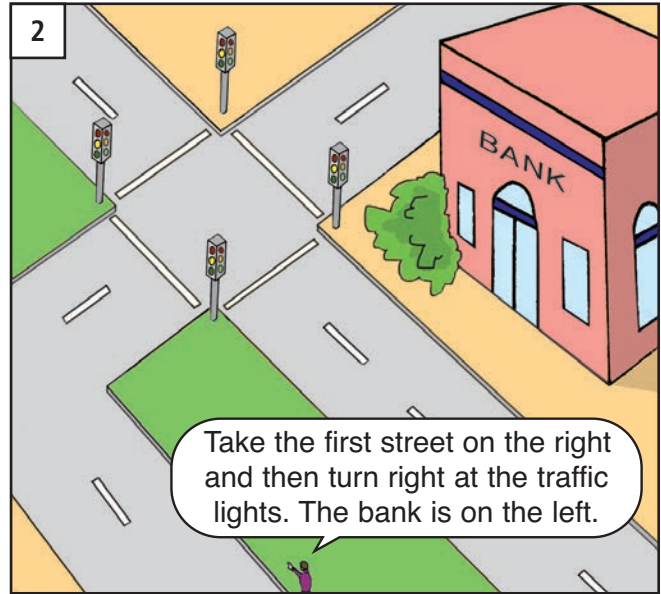
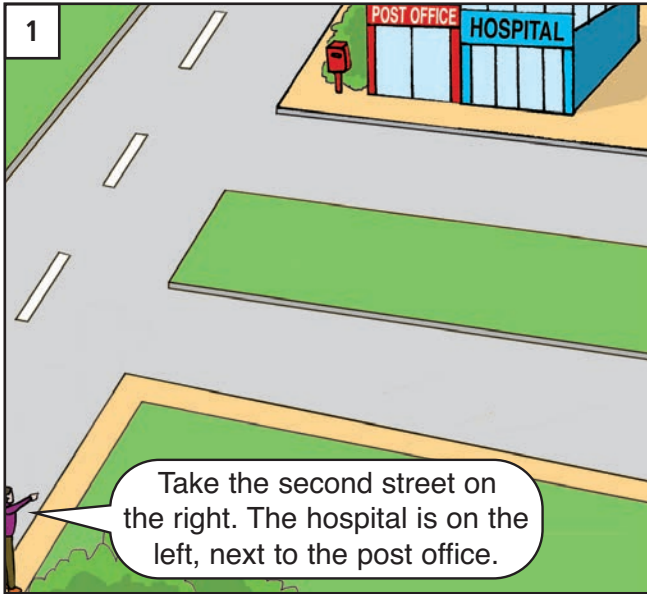

It's the second street on the left.

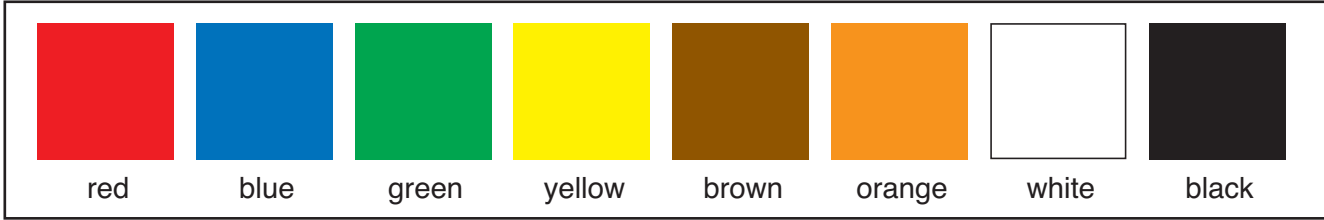

1

a red car

2

two red cars

3

a white car

4

two white cars

5

a red and white car

6

two red and white cars

7

a house

8

a roof

9

a fence

10

a white house with a red roof

11

a yellow house with a blue roof and a green fence

12

a

13

a

The Bensons

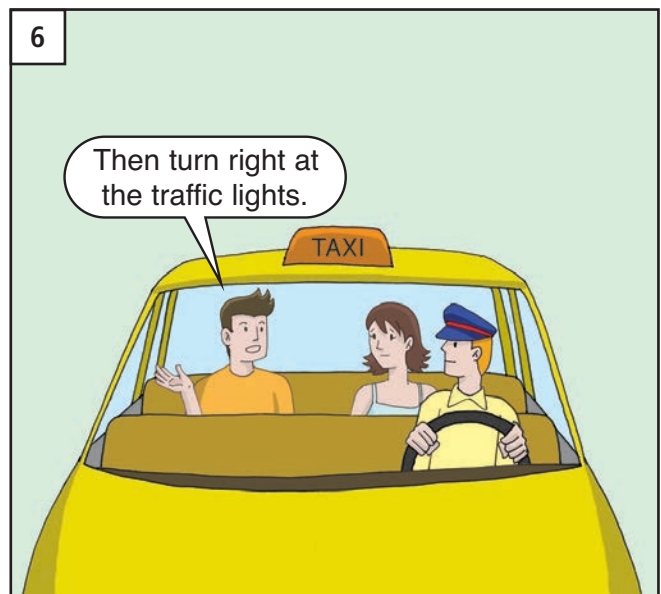
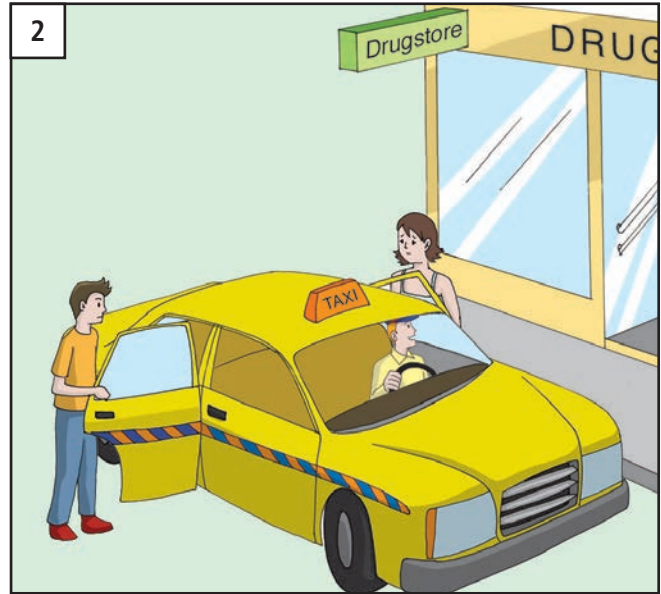
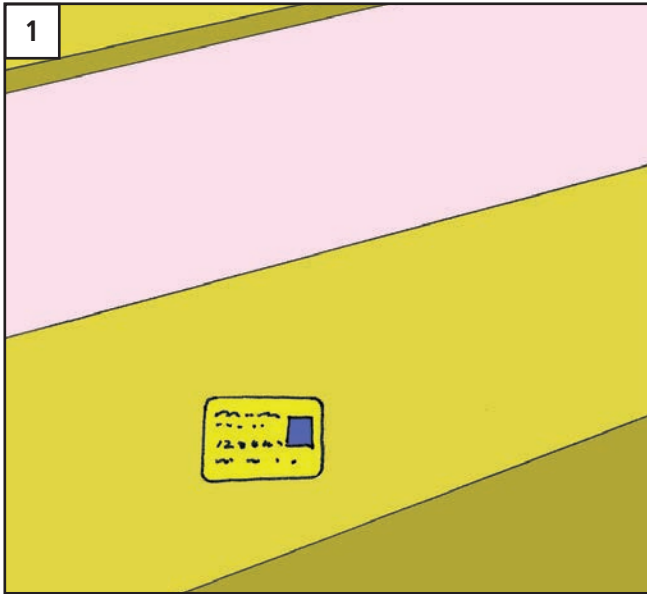

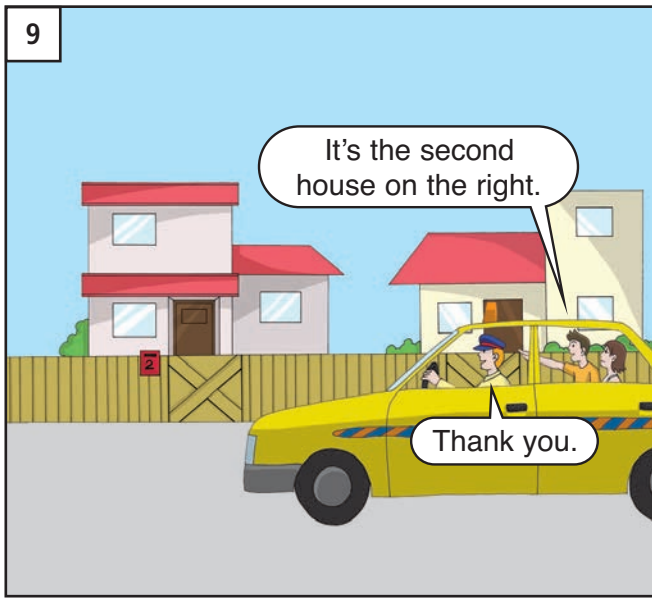
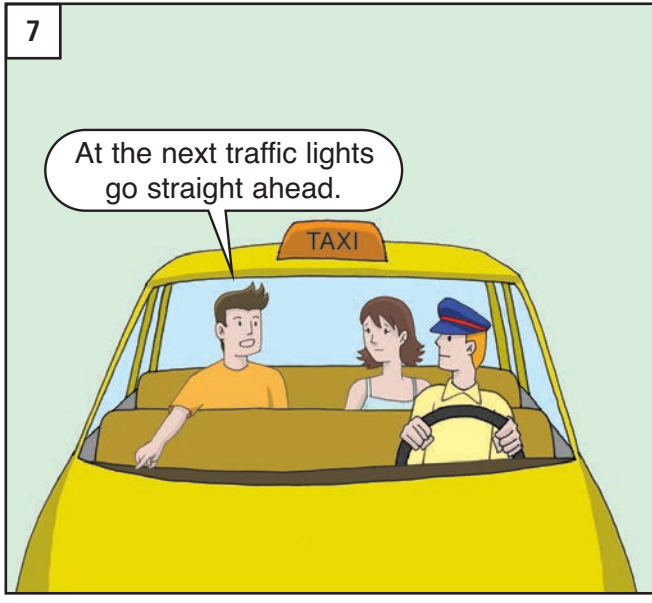

UNIT 15: Revision and extension

1



hand

.....

2

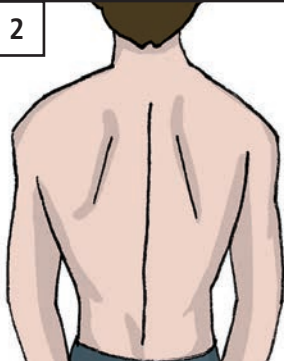

.....

3



.....

4



.....

5



.....

6



.....

7



.....

8



.....

9

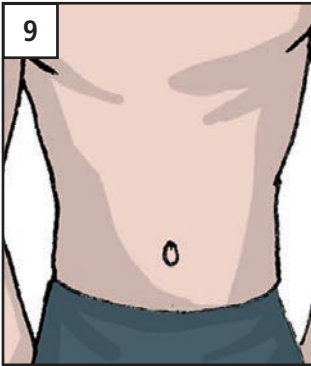

.....

10



.....

11



.....

12



.....

13



.....

14



.....

15



.....

16



.....

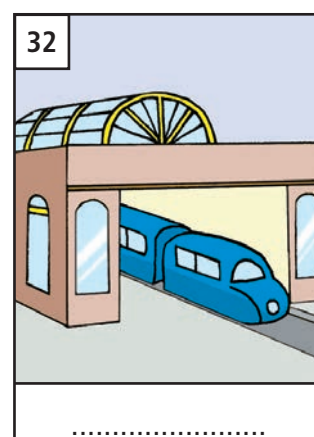
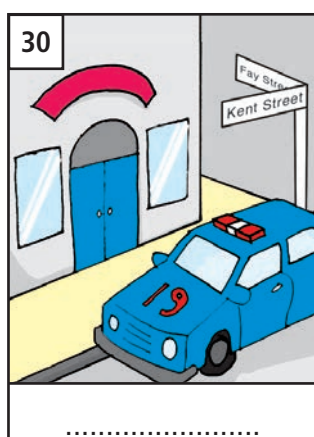
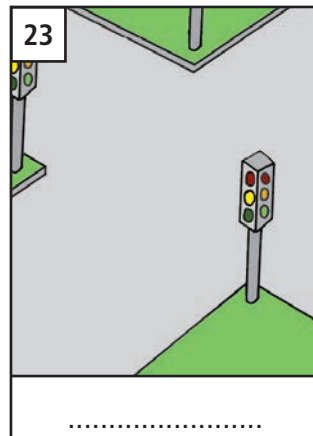
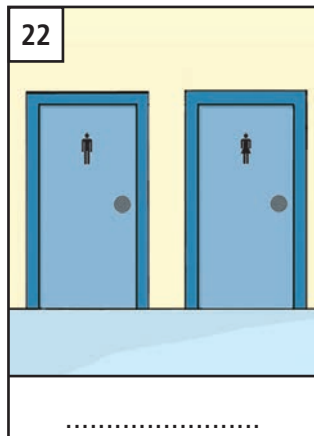
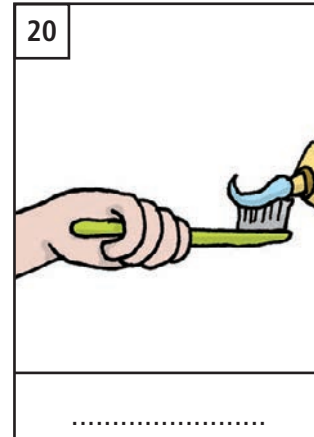
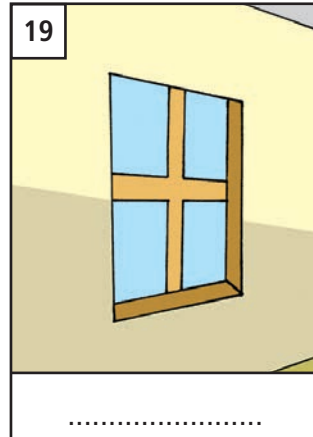
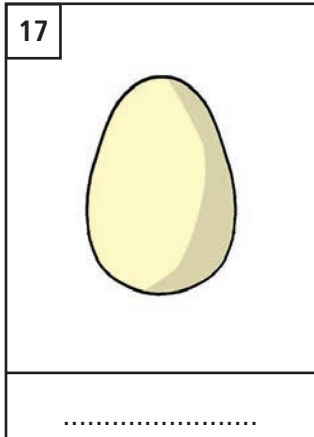

UNIT 15

A

- | | |
|-------------------------|----------------------------|
| 1. Good morning. | a. At 2 Richmond Street. |
| 2. What's the matter? | b. Better, thanks. |
| 3. I have a headache. | c. Good morning. |
| 4. How's your headache? | d. It's 2 Richmond Street. |
| 5. Where do you live? | e. I have a headache. |
| 6. What's your address? | f. I'm sorry to hear that. |

B

- | | |
|-----------------------------|-------------------------------------|
| 1. How's your headache now? | a. It's ten dollars. |
| 2. How much is this? | b. My arm hurts |
| 3. How much are they? | c. Credit, please. |
| 4. Cash or credit? | d. It's straight ahead on the left. |
| 5. Are you all right? | e. They're five dollars. |
| 6. Where's the hospital? | f. Much better, thanks. |

C

- | | |
|------------------------------|--------------------|
| 1. Do we have any apples? | a. Yes, she does. |
| 2. Do you play the violin? | b. Yes, we do. |
| 3. Do I need a ticket? | c. No, they don't. |
| 4. Does she have any cash? | d. Yes, he does. |
| 5. Does he play the trumpet? | e. No, I don't. |
| 6. Do they have a new car? | f. Yes, you do. |

hurt take chemist since evening at how for have



UNIT 15

repeat lights ahead left lights tell right left help ahead

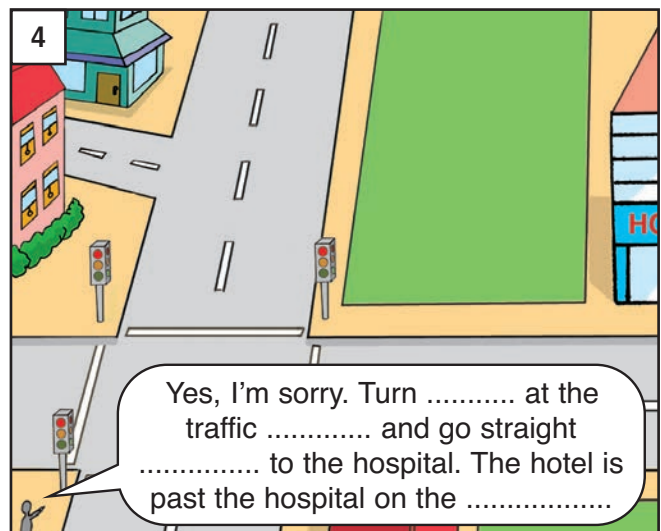
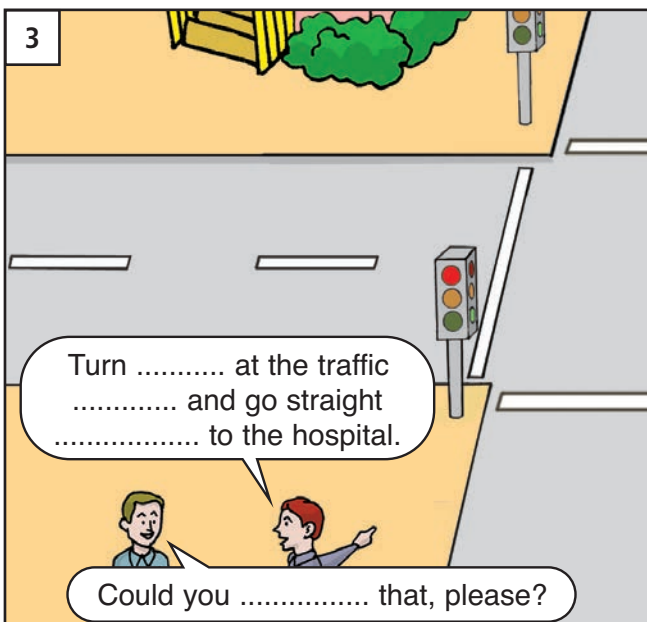
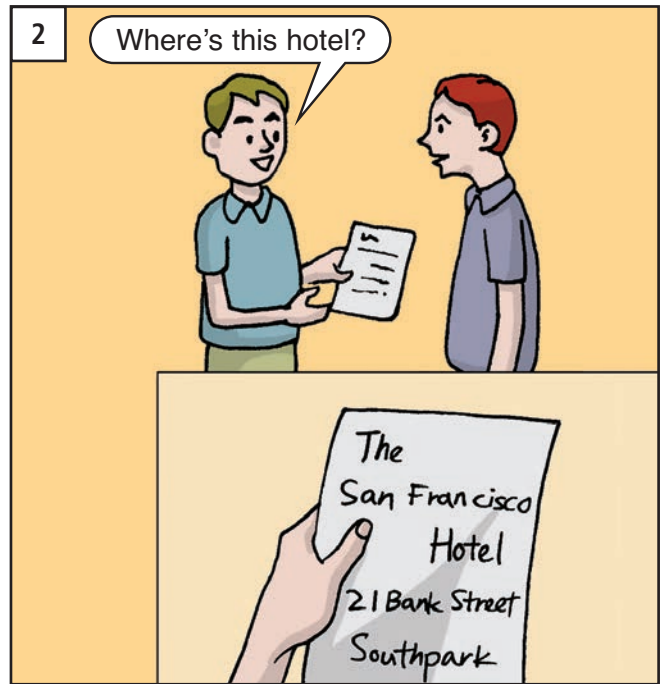
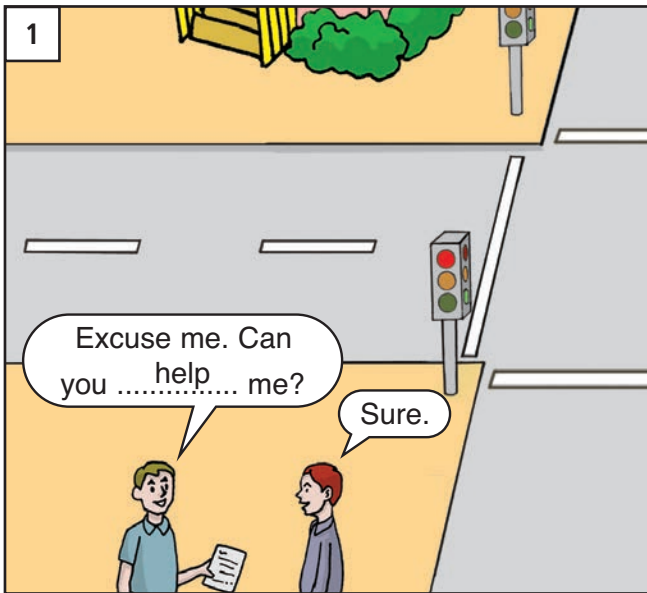
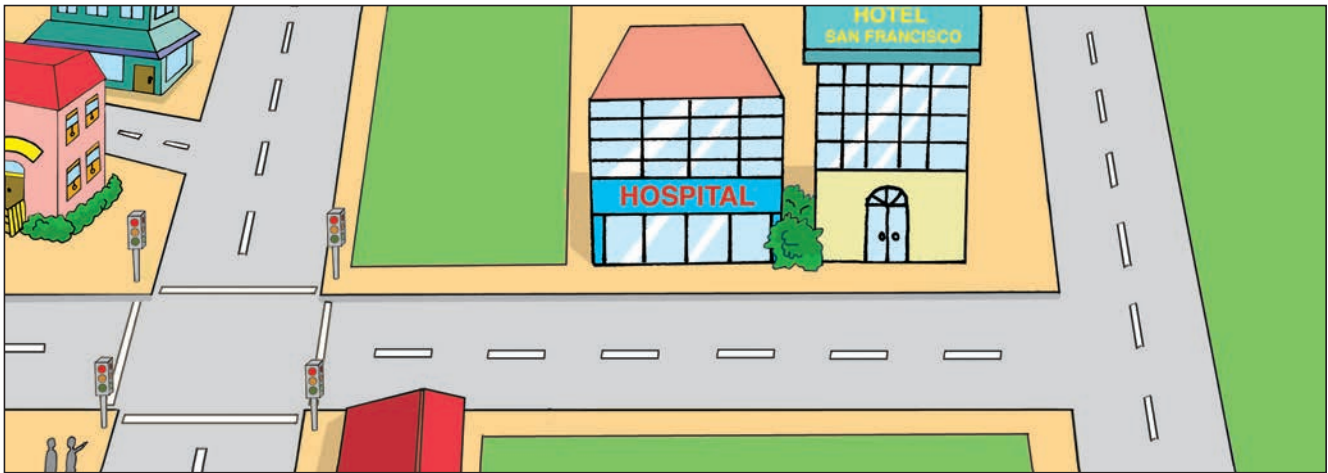

look

take

next

much

Where

like

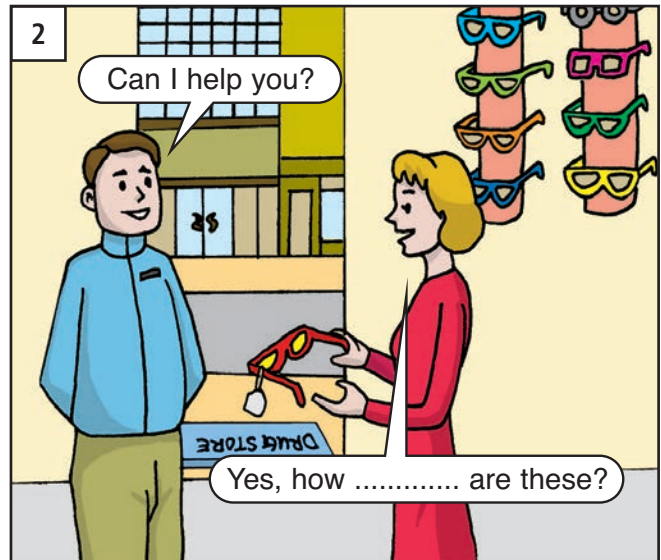

UNIT 15

live

I'll

How's

My

for

right

with

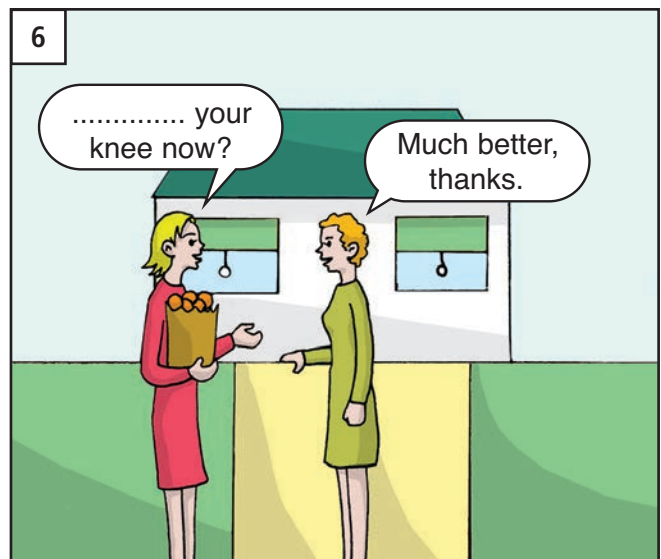

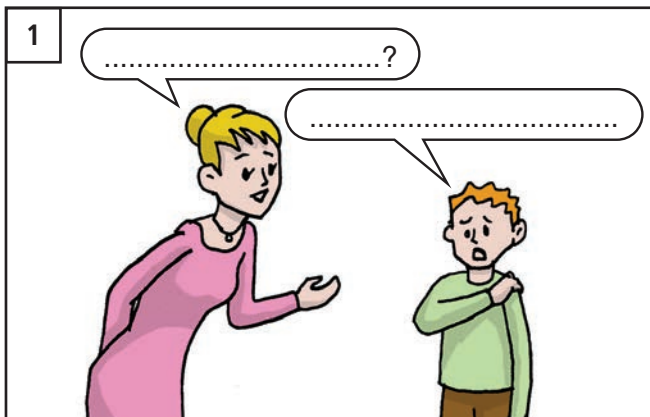

- wrong What's
- shoulder hurts My.

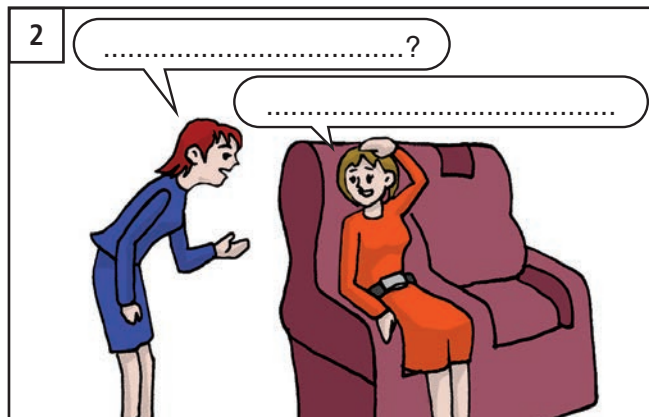

- matter the What's
- headache a have I

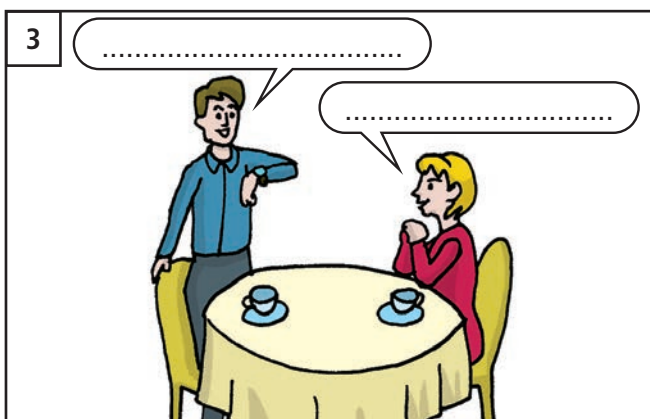

- I to go now have
- a What pity



- you do Where live
- 41 Wik Street live I at

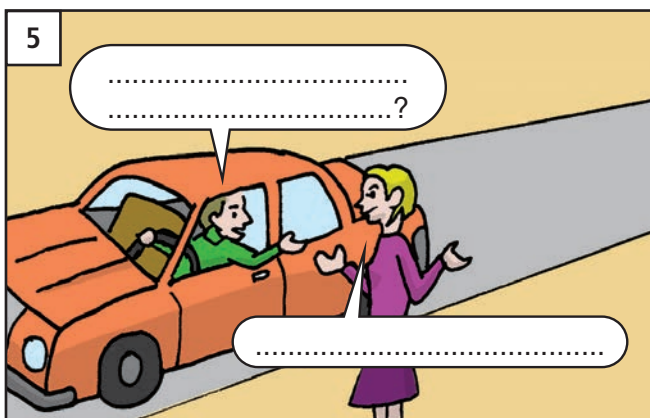

- me the car where's park Excuse
- Sorry know don't I



- bank the Where's
- corner It's the around

UNIT 15



- > ticket need a You
- > much How it is



- > I you help Can
- > these How Yes much shoes are



- > now your tooth How's
- > thanks Better



- > take Do Visa you
- > Sure

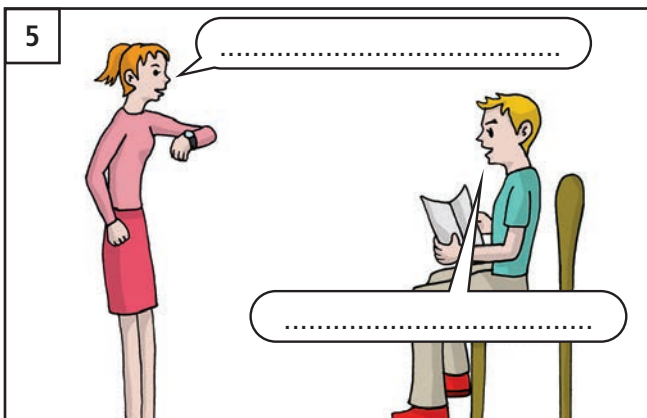

- > go We now to have
- > taxi a I'll call

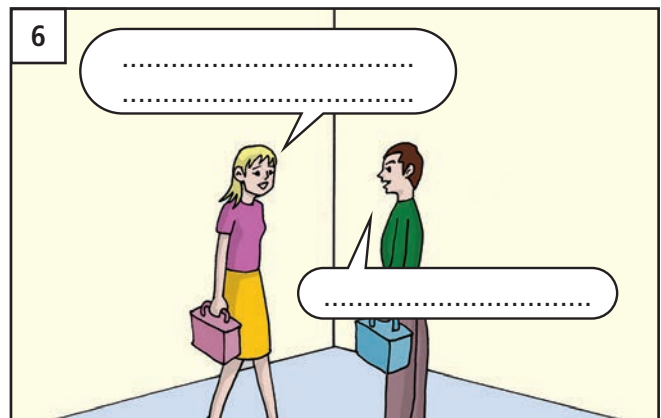

- > you me waiting for for Thank
- > OK That's

UNIT 15: Answers

Unit 15, page 132

- | | | | |
|------------|-----------|-----------|-----------------|
| 1. hand | 2. back | 3. ear | 4. foot |
| 5. head | 6. knee | 7. leg | 8. shoulder |
| 9. stomach | 10. arm | 11. tooth | 12. sun |
| 13. moon | 14. stars | 15. cash | 16. credit card |

Unit 15, page 133

- | | | | |
|------------------|--------------------|--------------------|---------------------|
| 17. egg | 18. address | 19. window | 20. toothbrush |
| 21. taxi rank | 22. toilet | 23. traffic lights | 24. gas station |
| 25. waiting room | 26. bank | 27. bus stop | 28. cinema |
| 29. hospital | 30. police station | 31. post office | 32. railway station |

Unit 15, page 134

- A. 1c 2e 3f 4b 5a 6d B. 1f 2a 3e 4c 5b 6d C. 1b 2e 3f 4a 5d 6c

Unit 15, page 135

2. how, have 3. Since 4. hurt 5. take, for, evening 6. at, chemist

Unit 15, page 136

1. help 3. left, lights, ahead, repeat 4. left, lights, ahead, right

Unit 15, page 137

1. Where 2. much 3. look 4. next 5. take 6. like

Unit 15, page 138

1. right, My 3. I'll 4. live, with 5. for 6. How's

Unit 15, page 139

1. What's wrong?
My shoulder hurts.
2. What's the matter?
I have a headache.
3. I have to go now.
What a pity.
4. Where do you live?
I live at 41 Wik Street.
5. Excuse me, where's the car park?
Sorry, I don't know.
6. Where's the bank?
It's around the corner.

Unit 15, page 140

1. You need a ticket.
How much is it?
2. Can I help you?
Yes. How much are these shoes?
3. How's your tooth now?
Better, thanks.
4. Do you take Visa?
Sure.
5. We have to go now.
I'll call a taxi.
6. Thank you for waiting for me.
That's OK.

UNIT 16: She bought a cake.

wash [wɔːʃ]

pull [pʊl]

push [puʃ]

open [oʊpən]

close [klaʊz]

talk [tɔːk]

write [raɪt]

sleep [sliːp]

buy [baɪ]

sell [sel]

drive [draɪv]

eat [iːt]

teach [tiːtʃ]

Mum [maːm]

was [wʌz]

were [wəːr]

clean [kliːn]

dirty [dɜːr'tiː]



it will =

it'll



he will =

he'll



she will =

she'll

turn
play
call
work
arrive
agree
wait
stop

turning
playing
calling
working
arriving
agreeing
waiting
stopping

turned
played
called
worked
arrived
agreed
waited
stopped

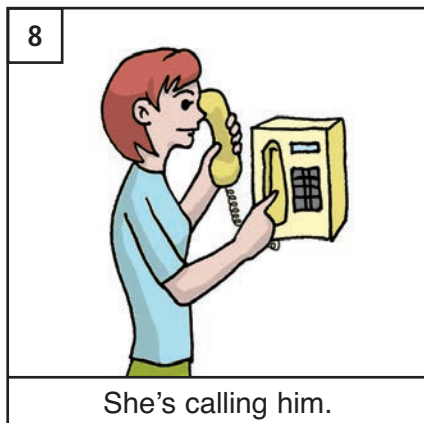
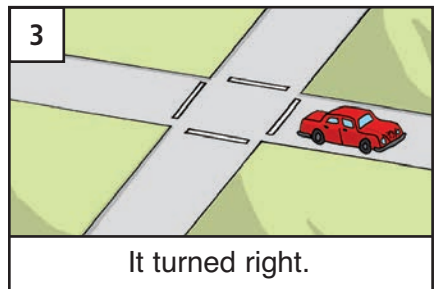
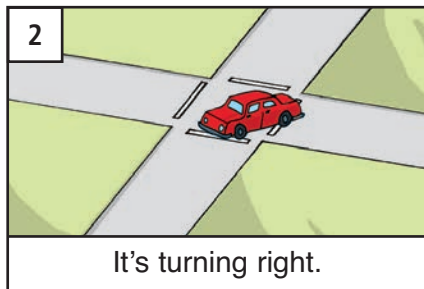
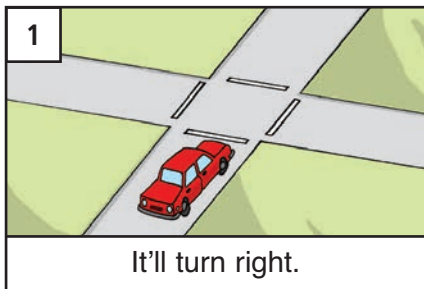

wash
open
close
pull
push
talk

washing
opening
closing
pulling
pushing
talking

washed
opened
closed
pulled
pushed
talked

UNIT 16

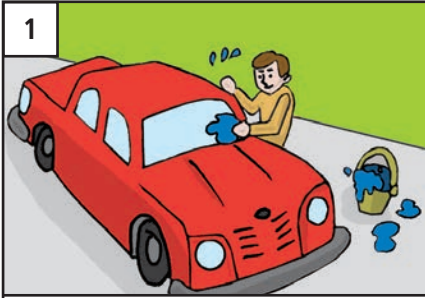

1 He's washing the car.



2 He's opening the door.



3 He's closing the door.

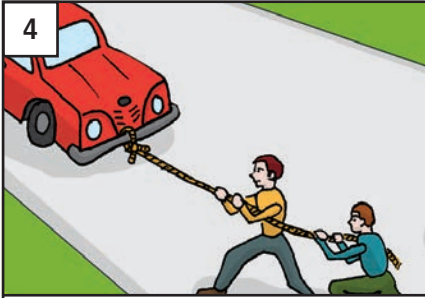

4 They're pulling the car.



5 They're pushing the car.

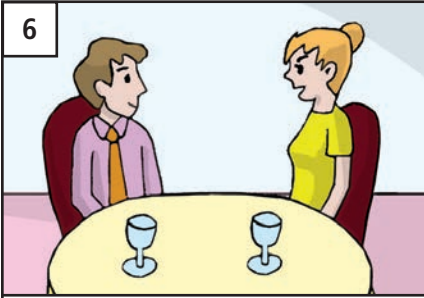

6 She's talking to him.



7 He'll pull the suitcase.



8 He's the suitcase.



9 He pulled the suitcase.



10 his hands.



11 He's washing his hands.



12 He his hands.



13 She'll close the window.



14 the window.



15the window.

She bought a cake.



they will = they'll

<p>run eat bring come go take do meet have leave think pay hurt get make teach</p>	<p>running eating bringing coming going taking doing meeting having leaving thinking paying hurting getting making teaching</p>	<p>ran ate brought came went took did met had left thought paid hurt got made taught</p>
--	---	--

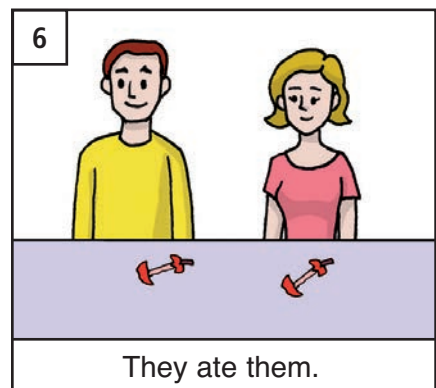
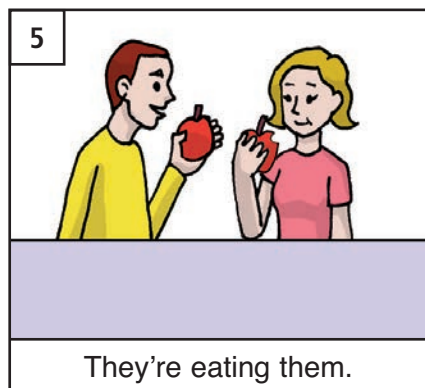
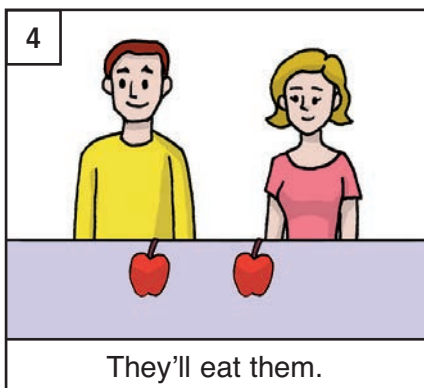
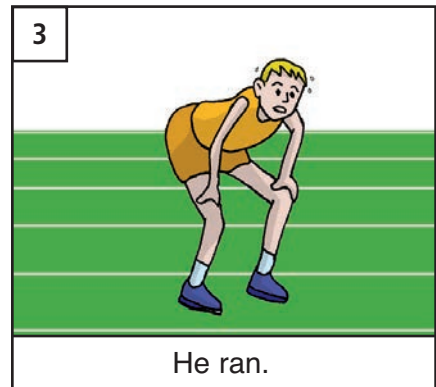
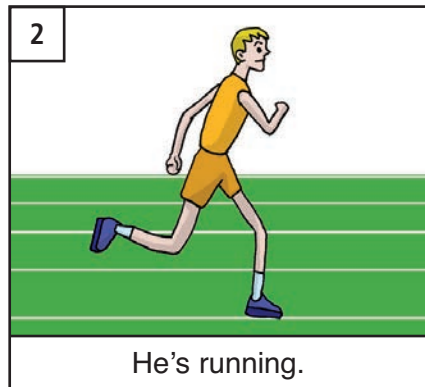
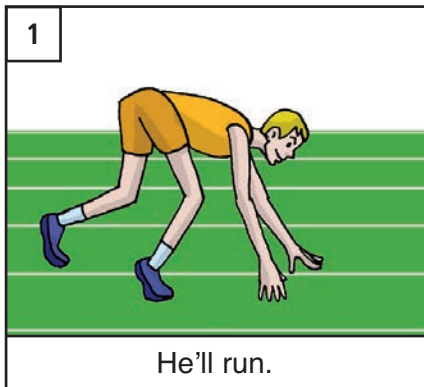

<p>sleep write buy sell drive</p>	<p>sleeping writing buying selling driving</p>	<p>slept wrote bought sold drove</p>
---	--	--

UNIT 16

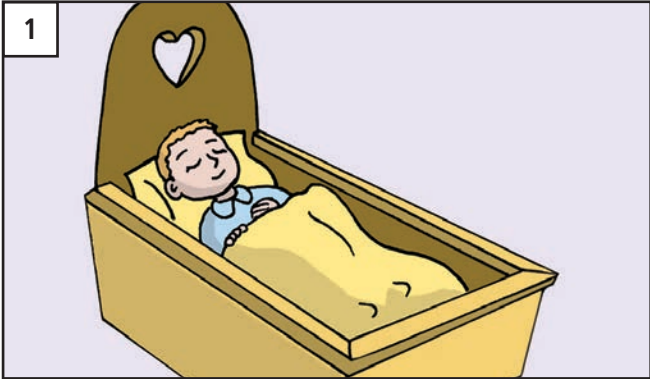

1 He's sleeping.



2 She's writing.



3 She's buying a ticket. He's selling a ticket.

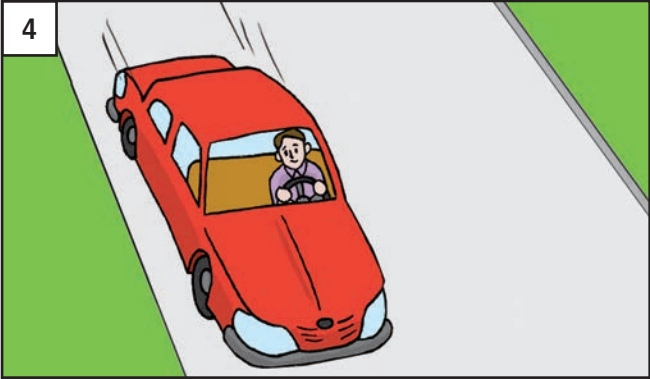

4 He's driving a car.



5 He'll sleep.

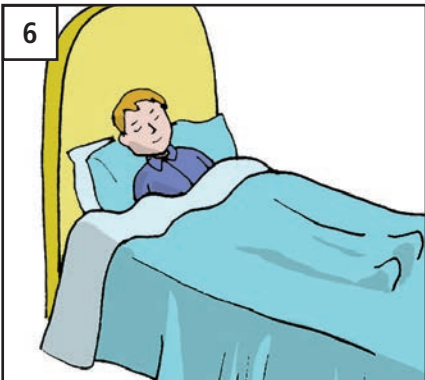

6 He's sleeping.



7 He

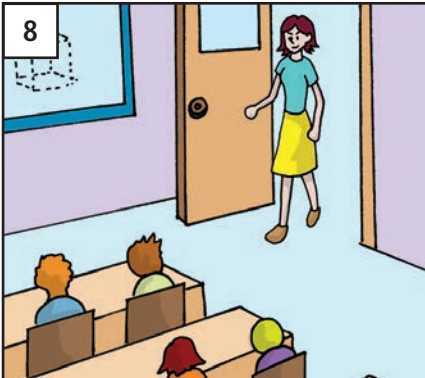

8 She'll teach them.



..... them.

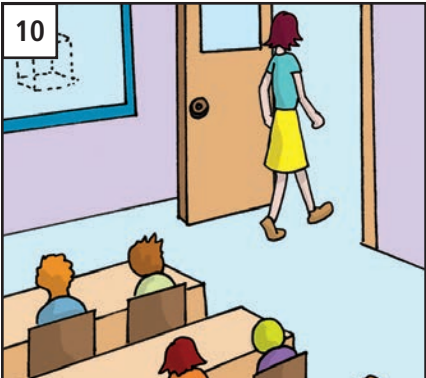

She them.

She bought a cake.



..... a cake.



She's buying a cake.



She a cake.

I am
You are
He is
She is
It is
We are
They are

I was
You were
He was
She was
It was
We were
They were

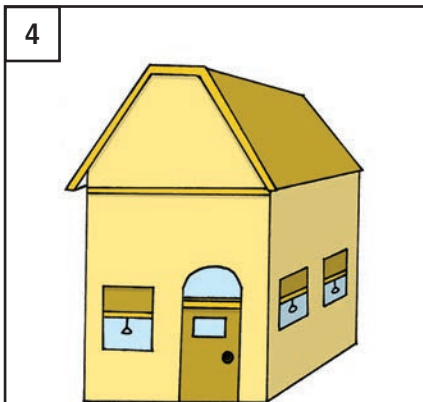

It's a yellow house.

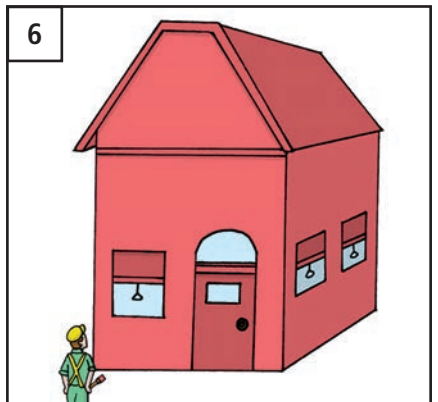
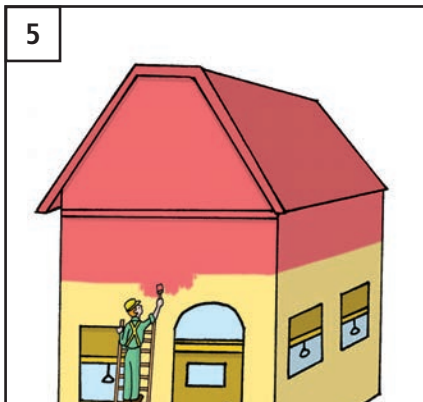

It was a yellow house.
Now it's a red house.

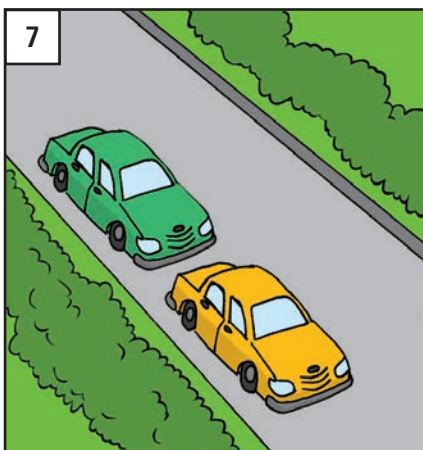

They're clean cars.

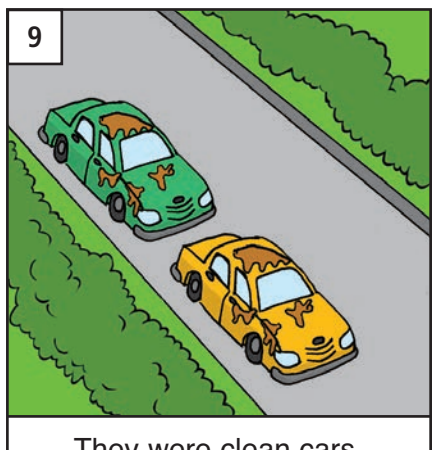
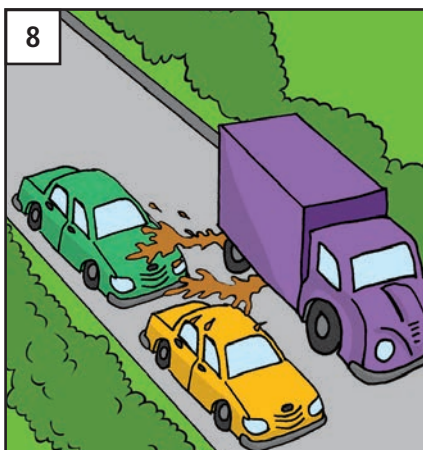

They were clean cars.
Now they're dirty cars.

The Bensons

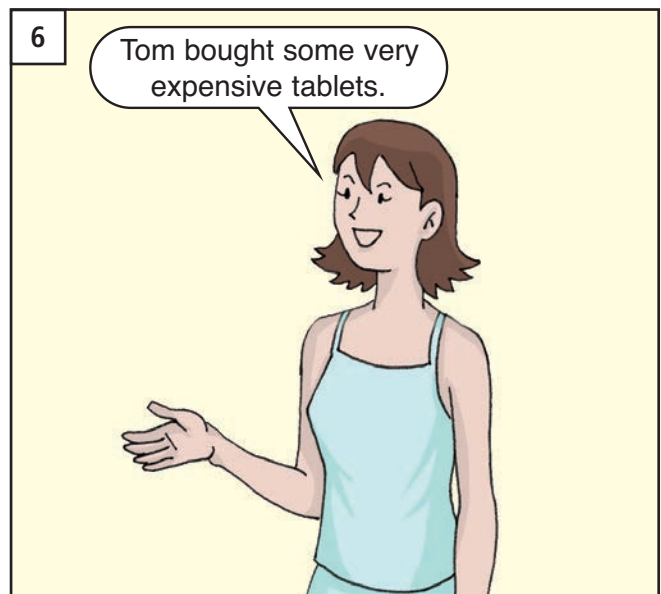
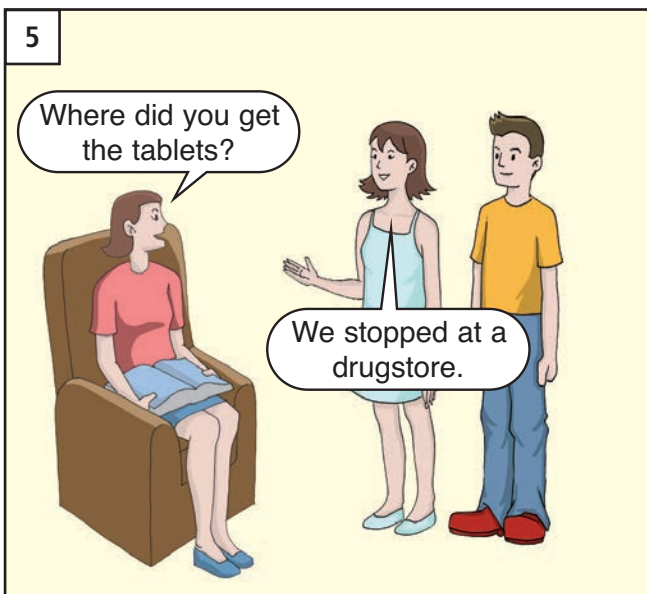
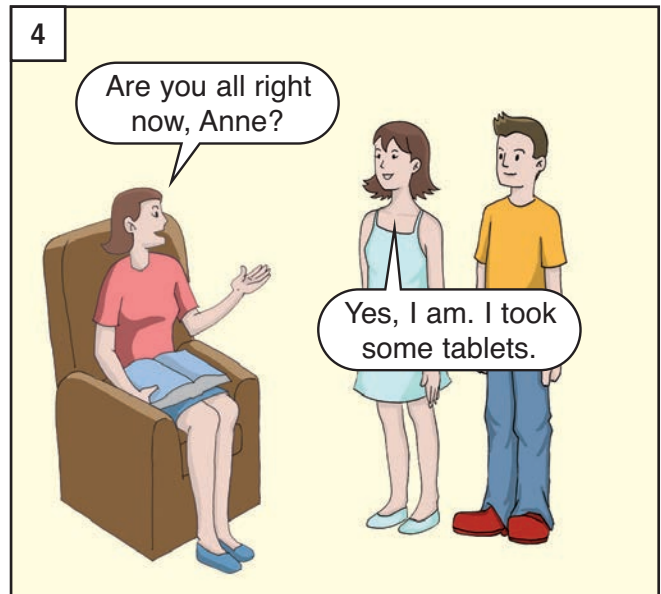
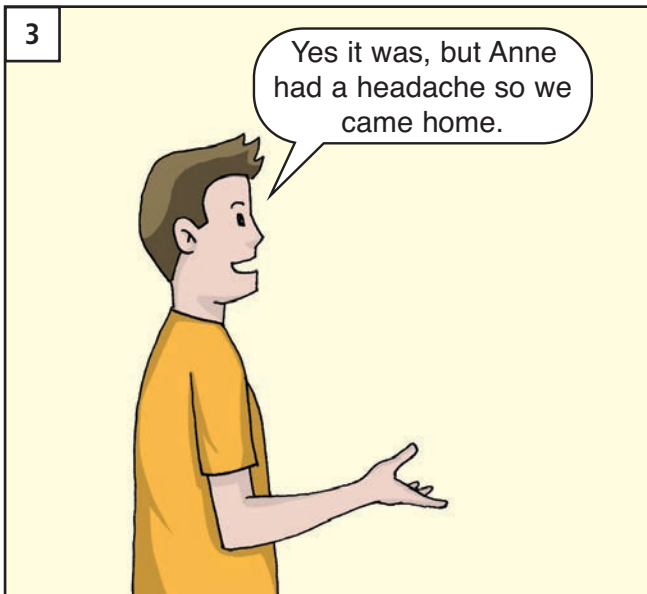
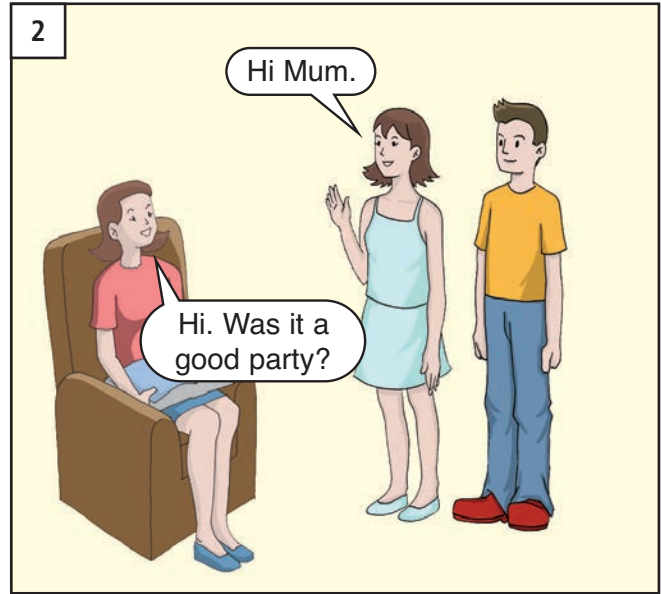



I will = I'll

7

Did you meet anyone at the party?

Yes. I met Ben and talked to him.

8

And I met Jill. She's Ben's sister.

And we met Steve. He's from Australia and he teaches English. Where's Dad?

9

He went to a meeting. How did you get home?

We called a taxi.

10

Did you have anything to eat?

No, but we had something to drink.

11

Would you like something to eat now?

Yes please.

No thanks. I think I'll go to bed.

12

Goodnight, Anne.

Goodnight.

UNIT 17: They're working in the garden.

read [ri:d]
watch [wɑ:tʃ]
work [wɜ:rk]
swim [swim]
shop [ʃɑ:p]
drink [driŋk]

newspaper [nu:z'peipə:r]
television [tel'əvɪʒən]
garden [gɑ:rdən]

play [plei]

chess [tʃes]
football [fut'bɔ:l]
golf [gɔ:lf]
tennis [ten'is]

telephone (phone) [tel'əfoun]

I'll get it. [aɪl get it]
speak [spi:k]
Who's calling? [hu:z kɔ:l'ɪŋ]

ask [æsk]
message [mes'idʒ]
leave a message [li:v ə mes'idʒ]
take a message [teɪk ə mes'idʒ]

hair [he:r]
have a haircut [hæv ə he:r'kʌt]

number [num'bɜ:r]

beep [bi:p]

busy [bɪzi:]

please [pli:z]

after [æf'tɜ:r]
before [bɪfɔ:r]

long [lɔ:ŋ]
short [ʃɔ:rt]
full [fu:l]
empty [em'ti:]

breakfast [brek'fæst]
lunch [lʌntʃ]
dinner [dɪn'ə:r]

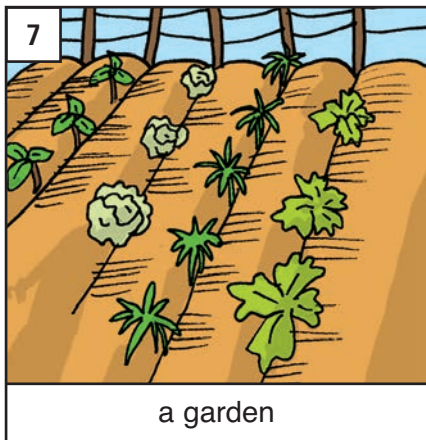
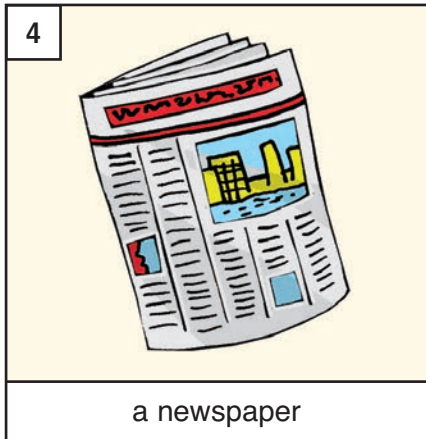
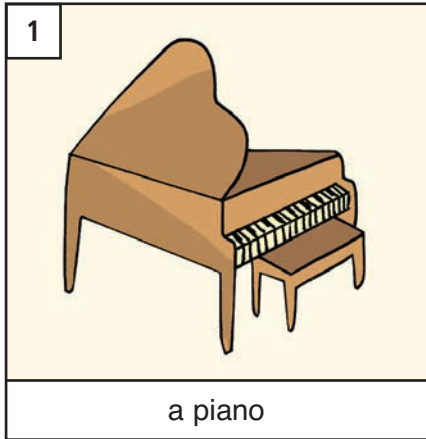

UNIT 17

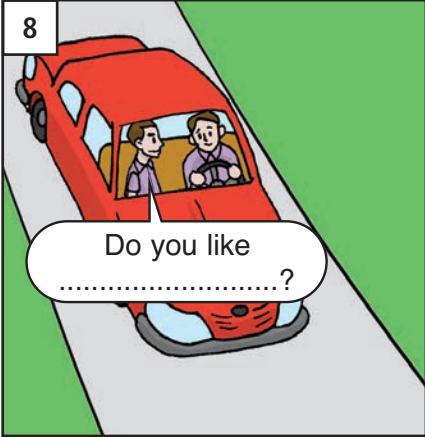
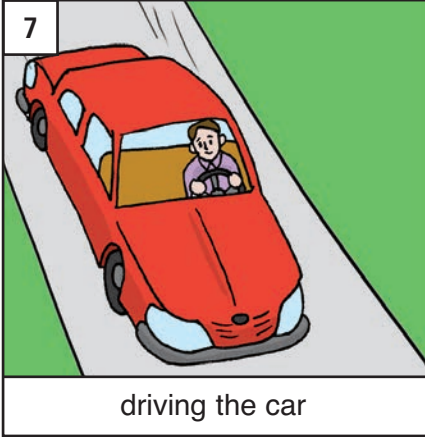
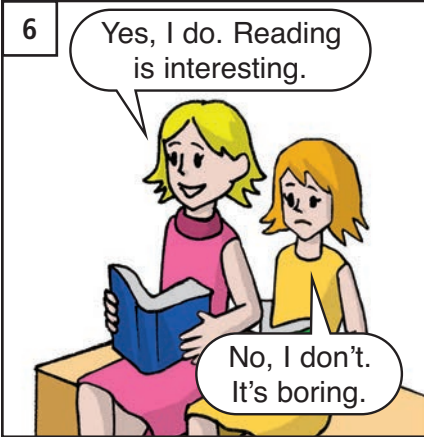
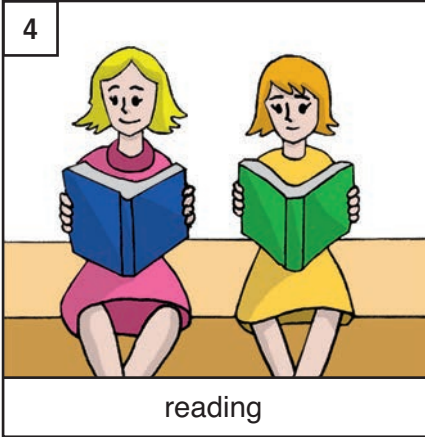
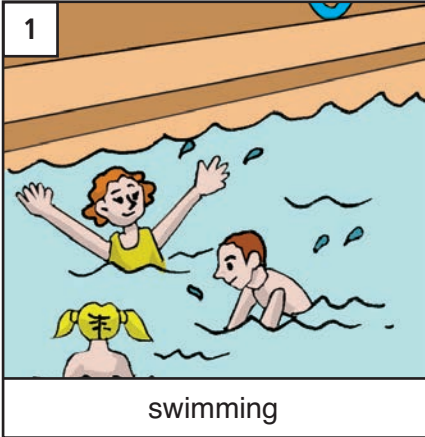

They're working in the garden.

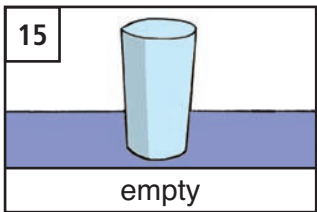
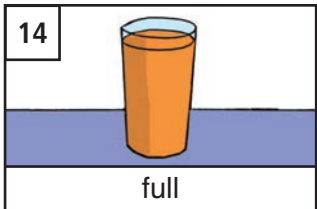
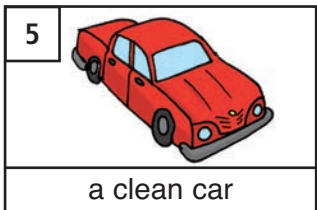
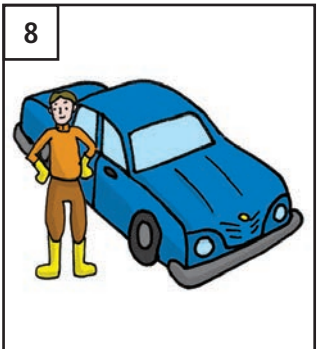
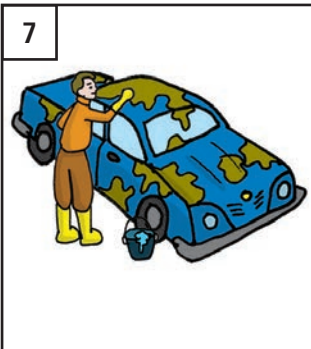
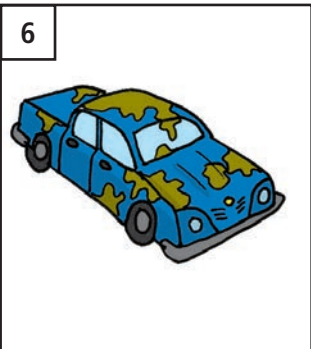
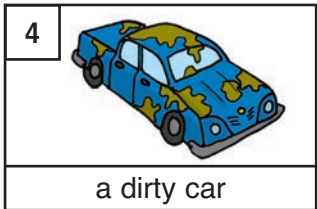
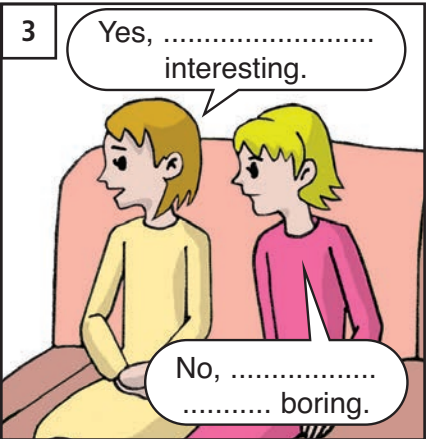
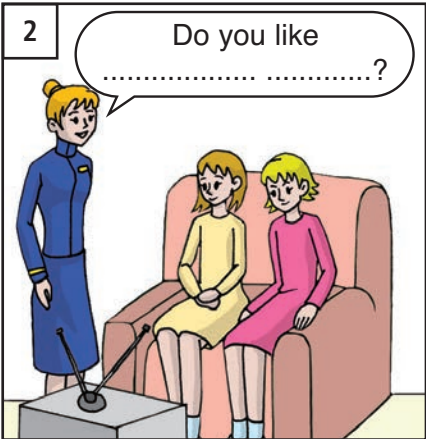
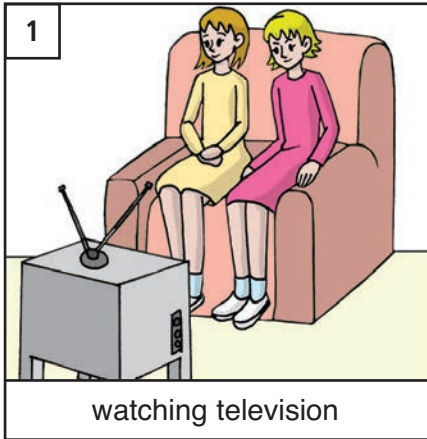



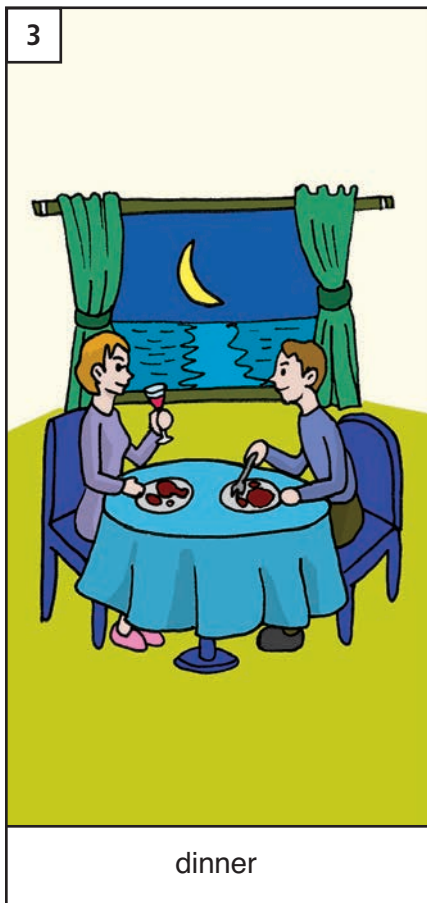
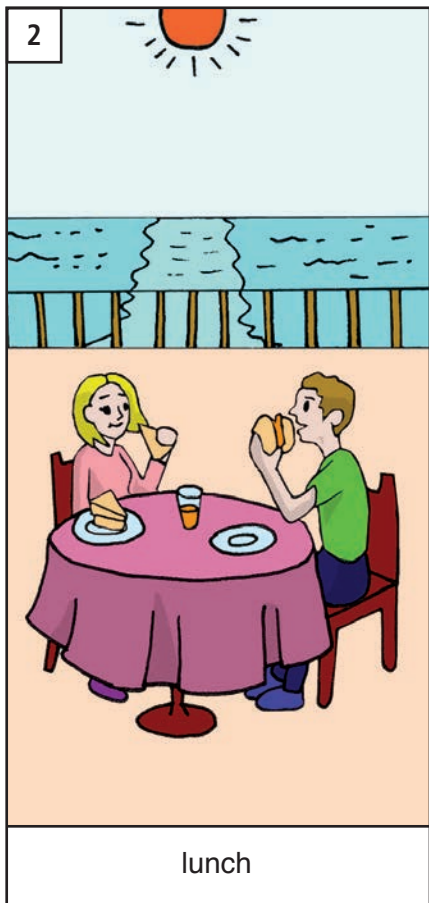
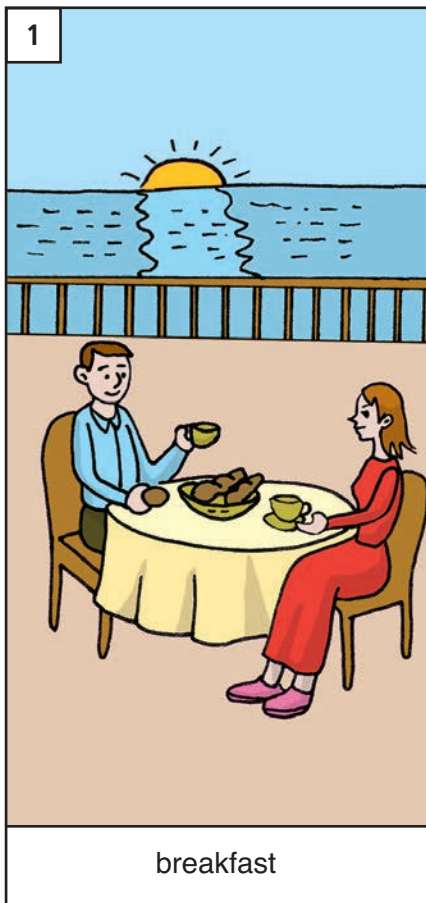

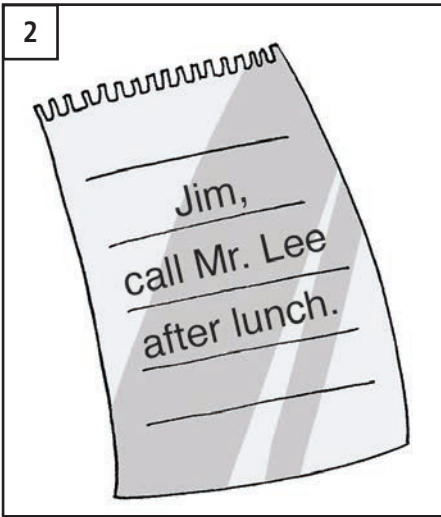

a message



leaving a message



taking a message

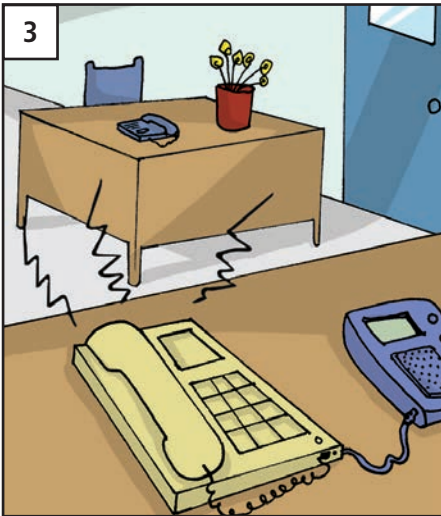

a telephone



Hello Alan. This is Jim. Please call me after lunch. Thanks. Bye.

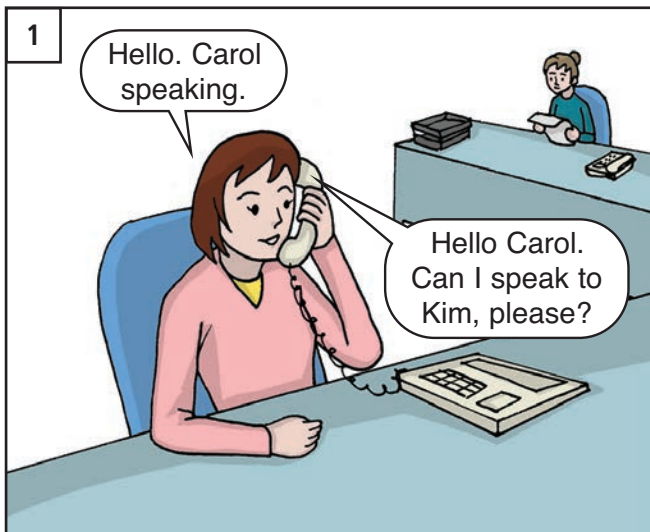



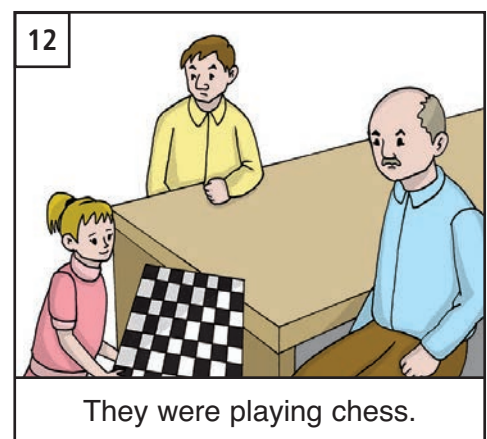
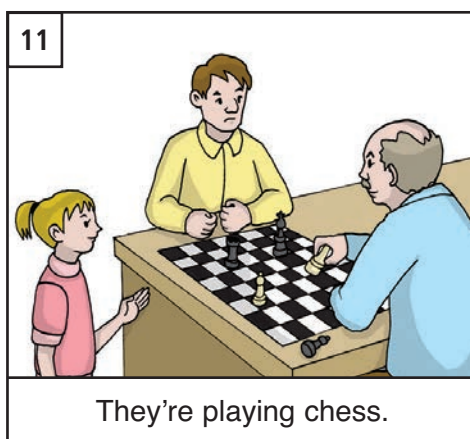
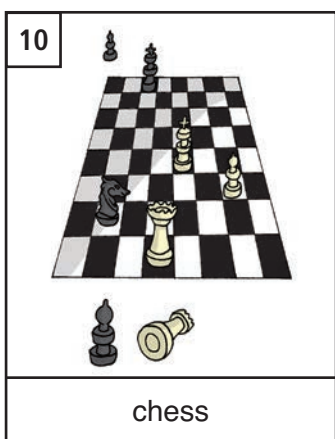
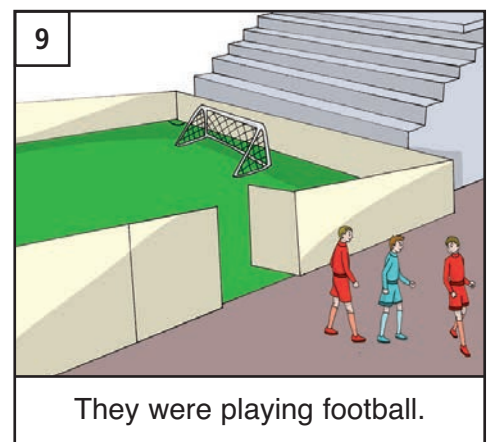
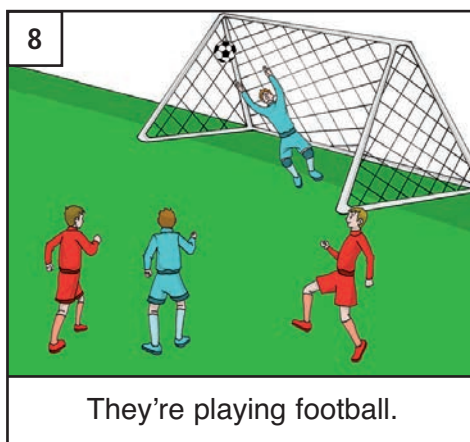
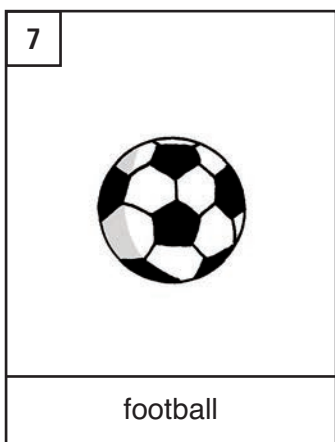
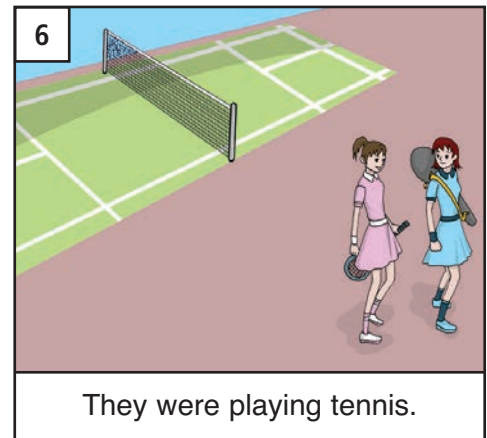
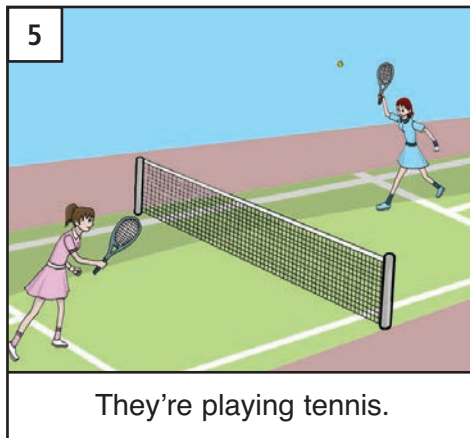
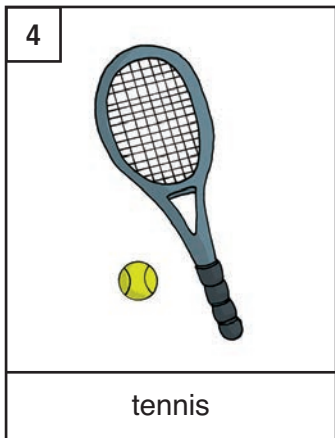
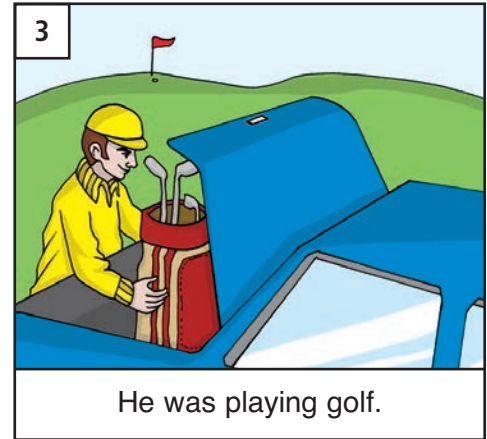
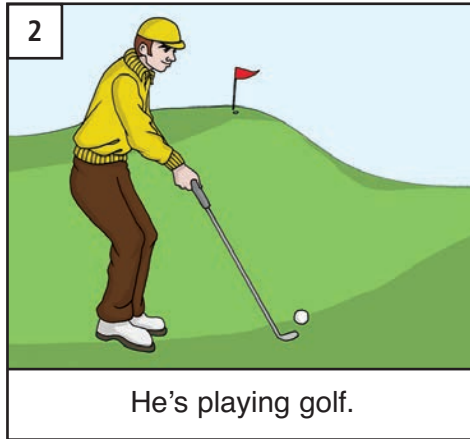
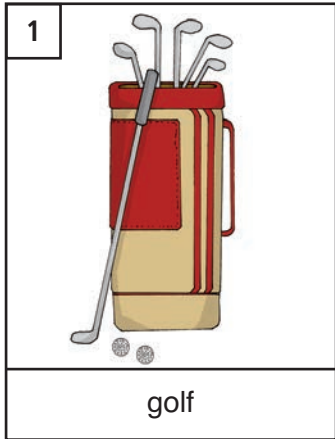

The Bensons

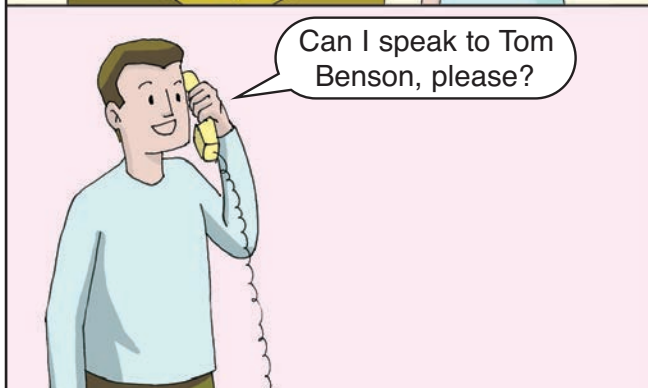
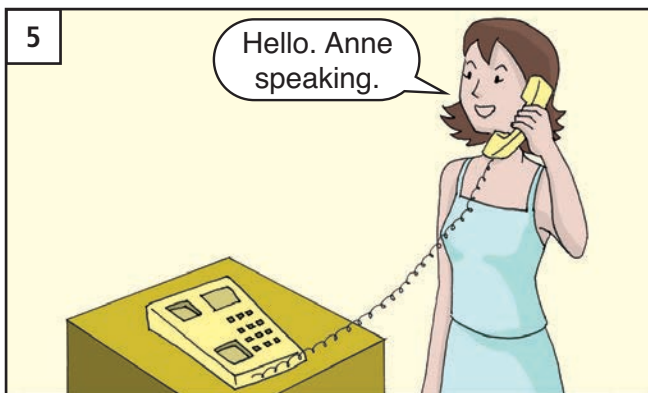
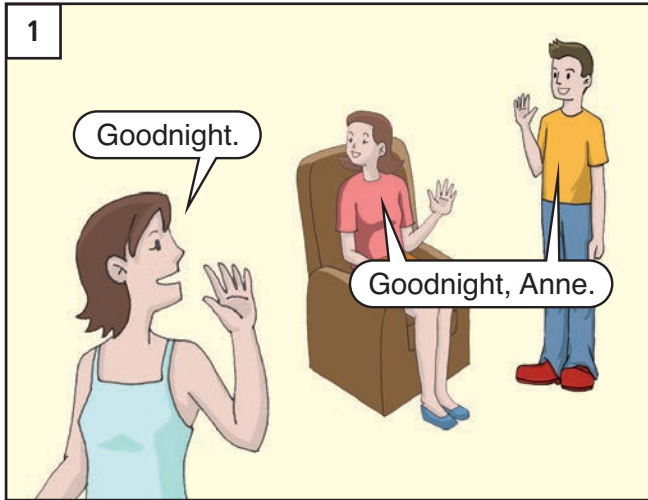



UNIT 18: What's the time?

Can you tell me the time, please?

[kæn ju: tel mi: ðə taim pli:z]

What's the time? [wʌtʒ ðə taim]

clock [kla:k]

quarter [kwɔ:r'tɔ:r]

half [hæf]

o'clock [əkla:kʻ]

a quarter past [ə kwɔ:r'tɔ:r pæst]

half past [hæf pæst]

a quarter to [ə kwɔ:r'tɔ:r tu:]

a.m. [ei em]

p.m. [pi: em]

appointment [əpɔɪnt'mənt]

flight [flaɪt]

wedding [wed'ɪŋ]

angry [æŋ'grɪ:]

happy [hæp'i:]

sad [sæd]

worried [wə'ri:d]

welcome [wel'kəm]

yesterday [jes'tɔ:rdɛɪ]

today [tədeɪʻ]

tomorrow [təmɔ:r'ou]

early [ɜ:r'li:]

late [leɪt]

1

some clocks

2

one o'clock

3

two o'clock

4

three o'clock

5

one o'clock

6

two o'clock

7

three o'clock

8

a watch

9

What's the time, please?

It's two o'clock.

10

one fifteen

11

one thirty

12

one forty-five

13

a quarter

14

a quarter past one

15

a quarter past nine

1

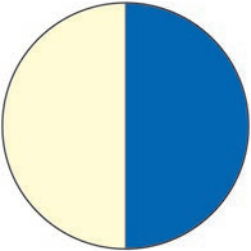

a half

2

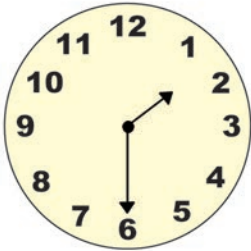

half past one

3

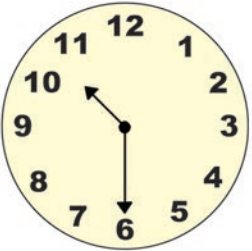

half past ten

4

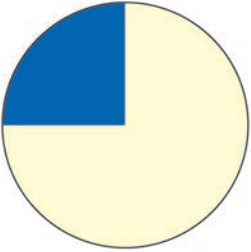

a quarter

5

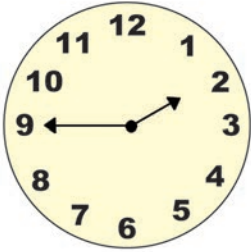

a quarter to two

6

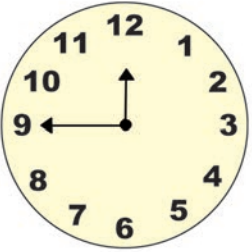

a quarter to twelve

7

Can you tell me the time, please?



It's a quarter past five.

8

Can you tell me the time, please?



It's half past five.

9

Can you tell me the time, please?



It's a quarter to six.

10

.....



.....

11

.....



.....

12

.....



.....



when is = when's



3

1:05

five past one
one o five

4

1:10

ten past one
one ten

5

1:15

a quarter
past one
one fifteen

6

1:20

twenty past one
one twenty

7

1:25

twenty-five
past one
one twenty-five

8

1:35

twenty-five
to two
one thirty-five

9

1:40

twenty to two
one forty

10

1:45

quarter to two
one forty-five

11

1:50

ten to two
one fifty

12

1:55

five to two
one fifty-five

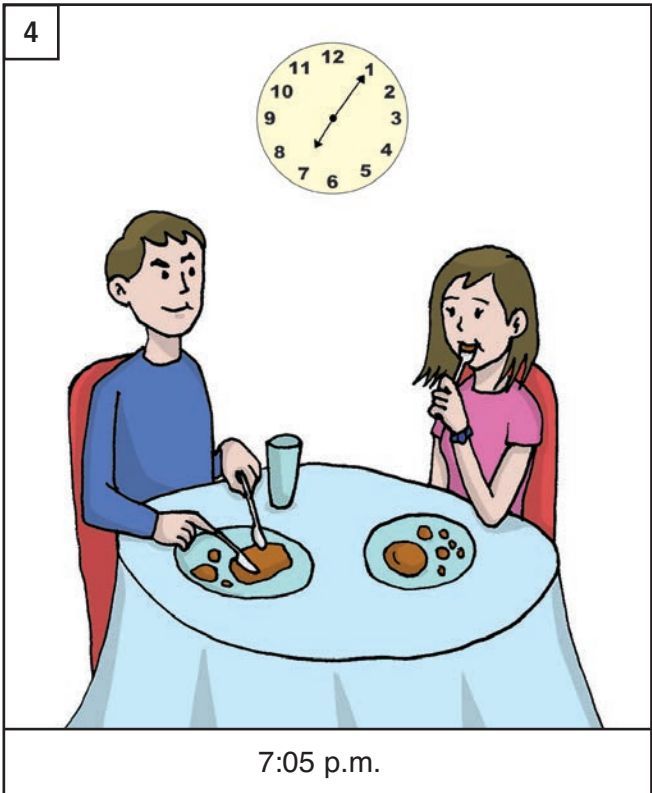



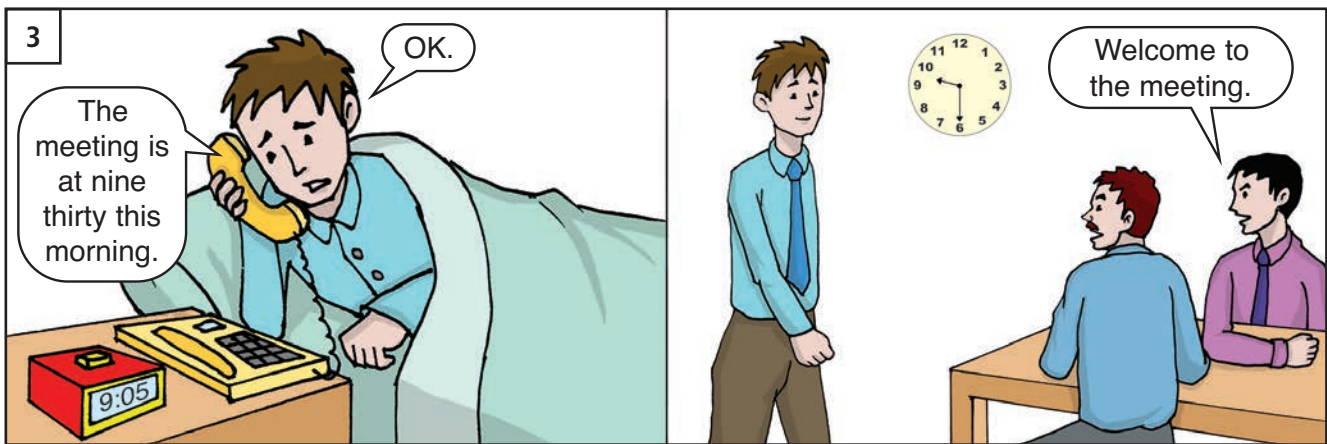

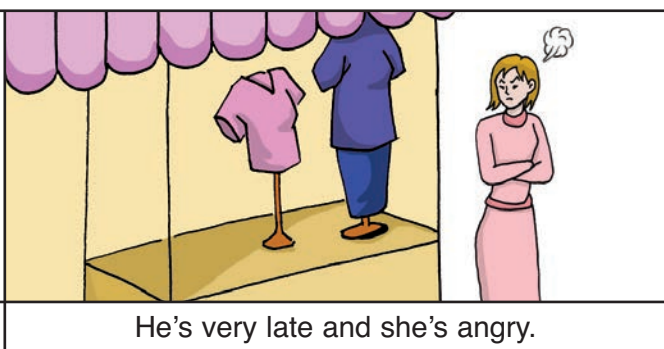
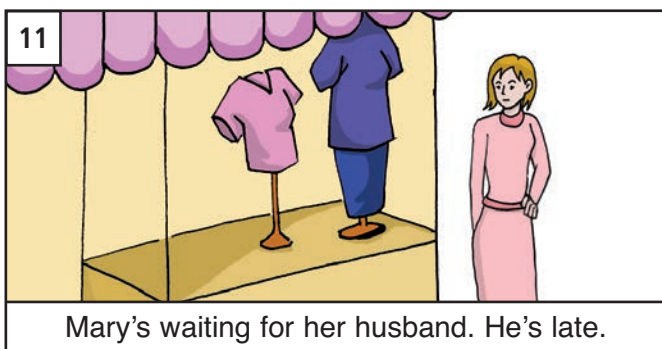
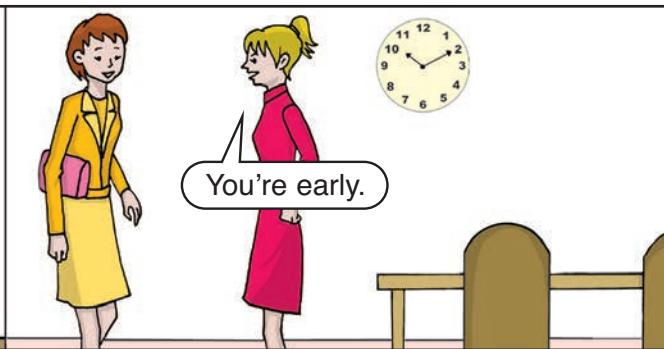
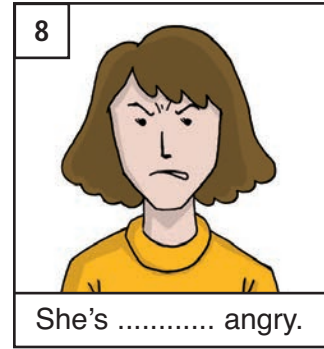
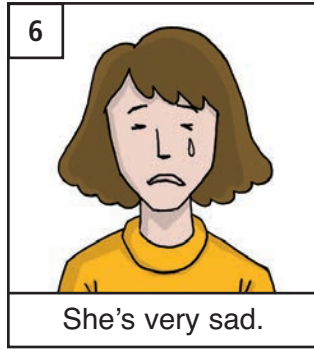
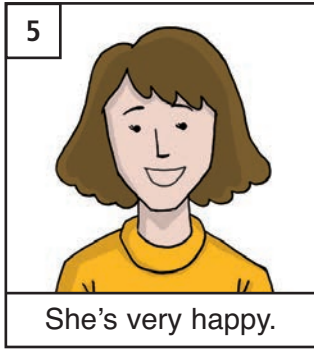
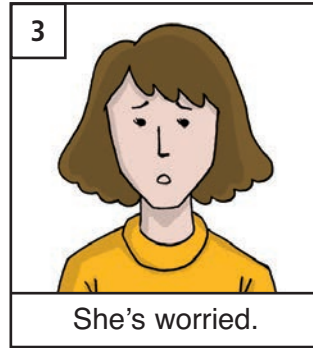
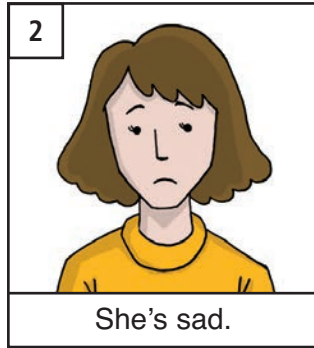
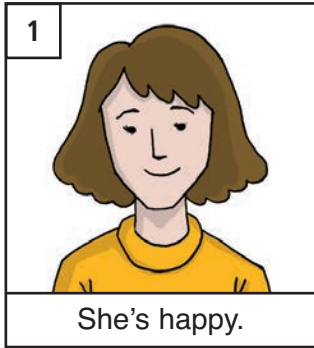

The Bensons

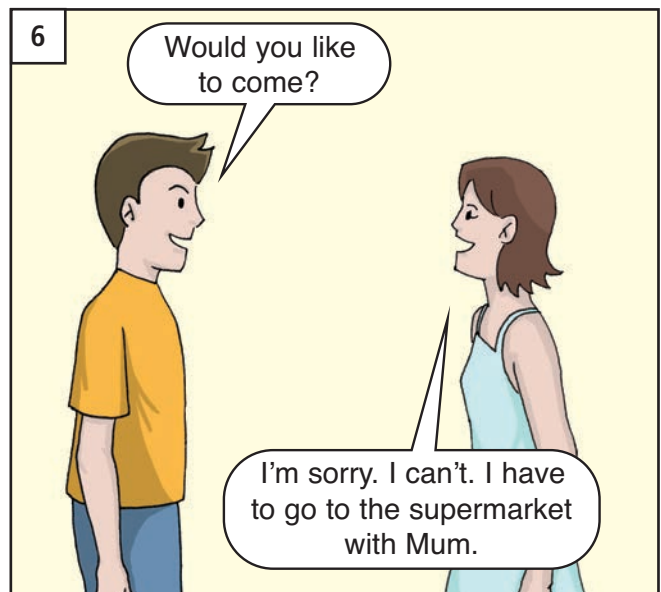
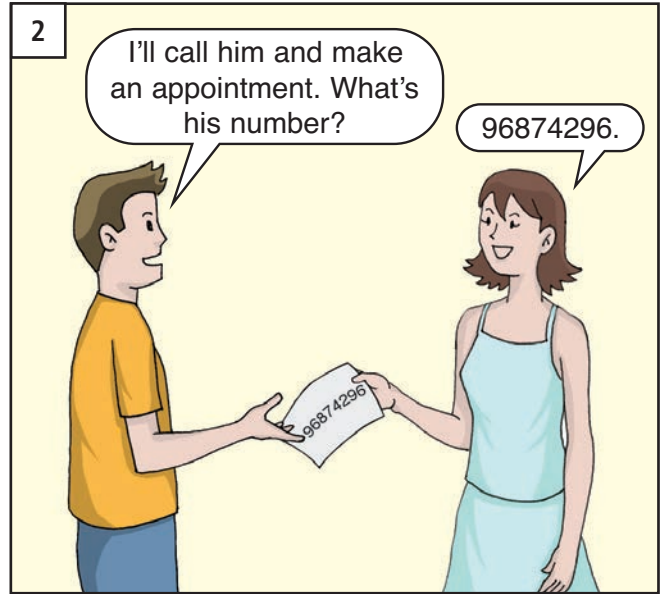

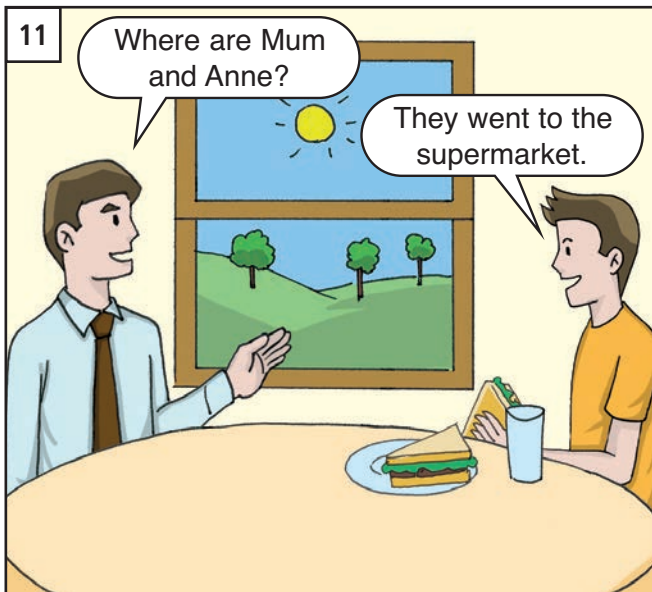
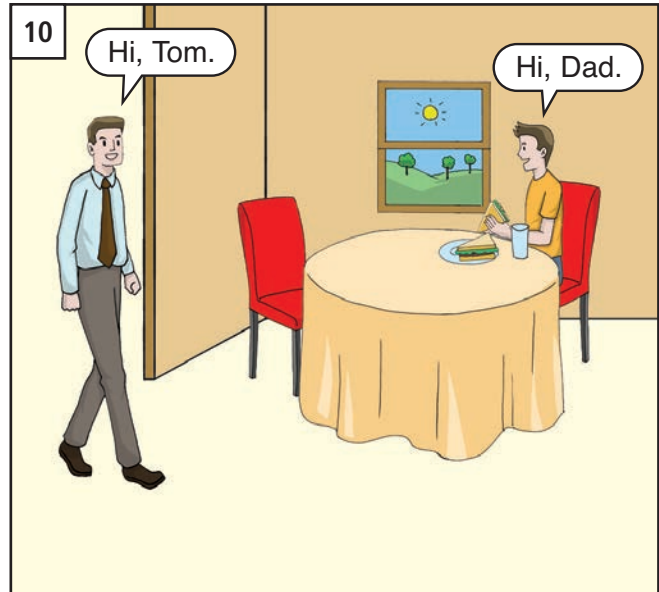
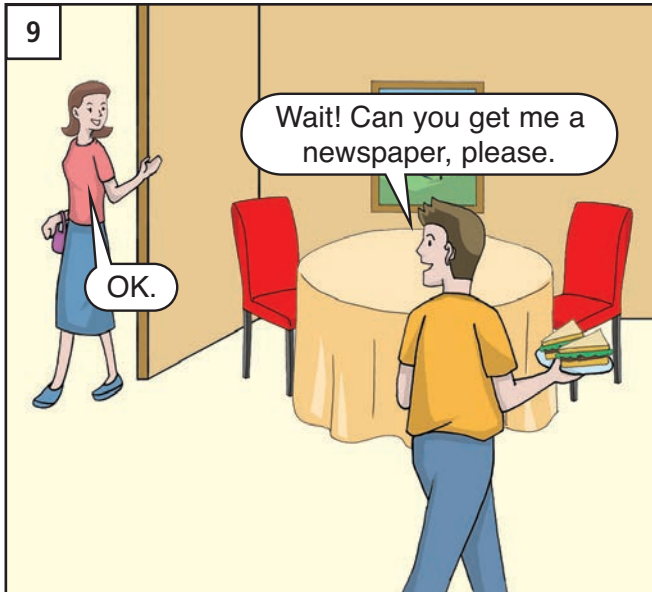
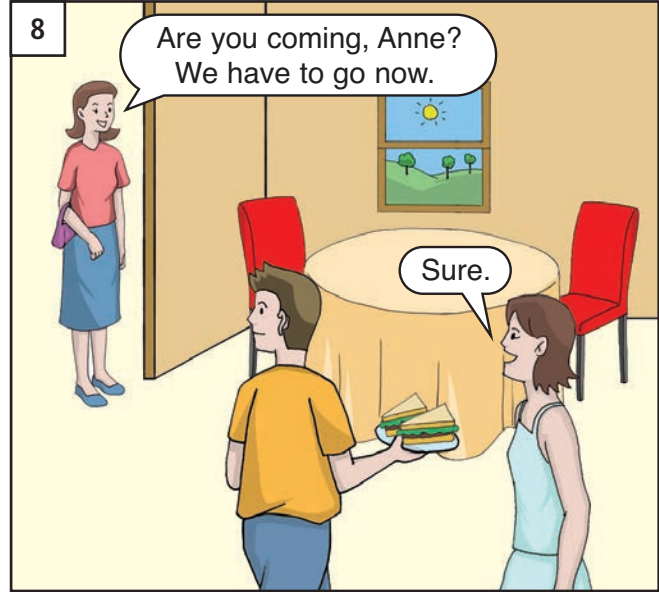
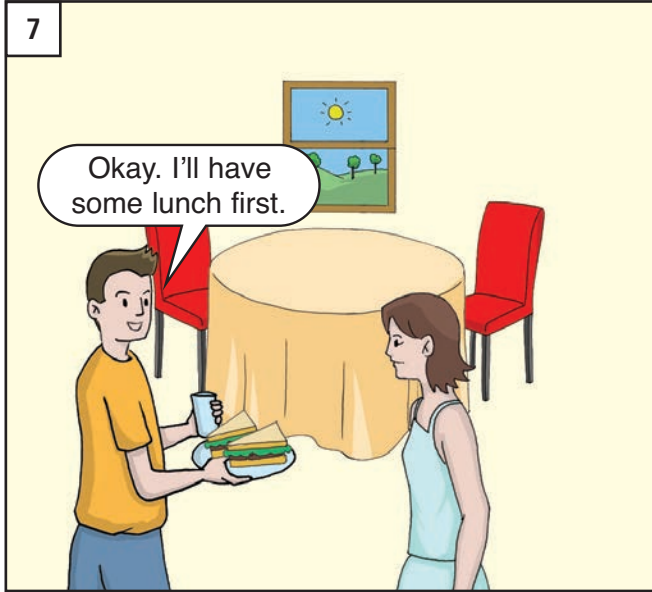

UNIT 19: You're not allowed to park here.

Does this bus go to... ? [dʌz ðis bʌs ɡou tu:]

Can you tell me when to get off
[kæn ju: tel mi: wen tu: get ɔ:f]

How long... ? [hau lɔ:ŋ]

timetable [taɪm'teɪbəl]

bicycle [baɪ'sɪkəl]

ferry [fe:rɪ:]

tram [træm]

heat [hi:t]

miss [mɪs]

use [ju:z]

park [pɑ:rk]

heated [hi:t'ɪd]

missed [mɪst]

used [ju:zd]

parked [pɑ:rkt]

second [sek'ənd]

minute [mɪn'ɪt]

hour [aʊə:r]

You're not allowed to...

[ju:r na:t əlaʊd tu:]

No parking [nəʊ pɑ:rkɪŋ]

get off [get ɔ:f]

get on [get a:n]

change [tʃeɪndʒ]

Here you are. [hi:r ju: a:r]

1

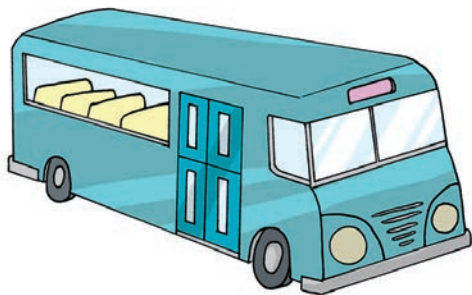

a bus

2

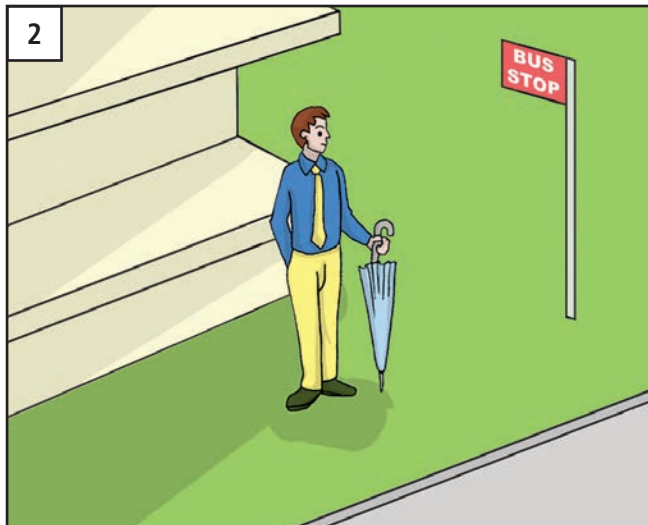

He's waiting for the bus.

3

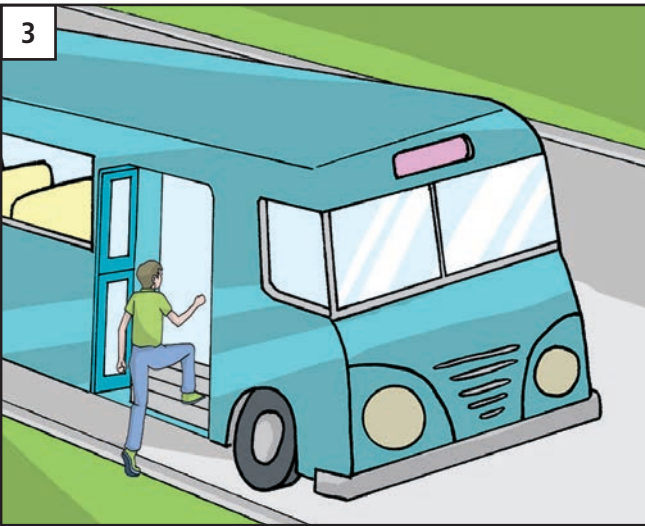

He's getting on the bus.

4

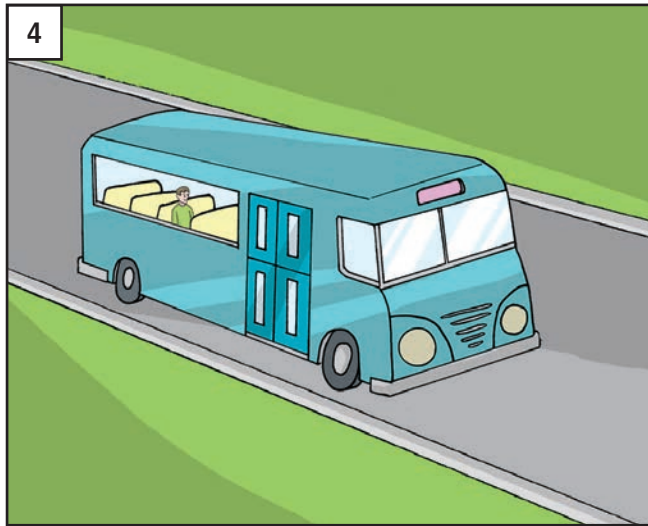

He's going by bus.

5

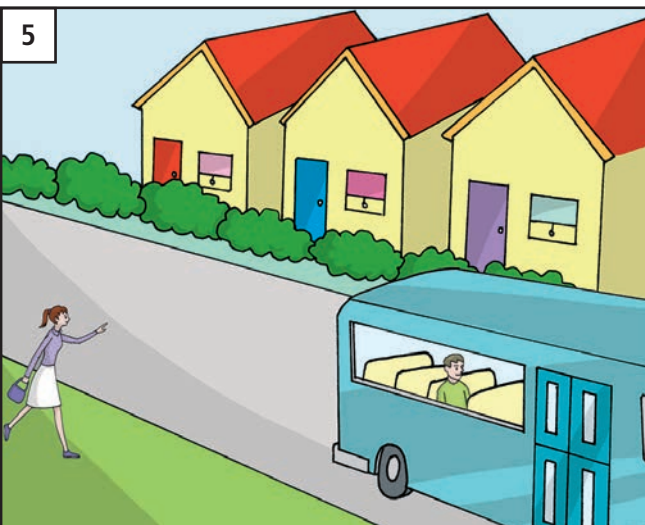

She missed the bus.

6

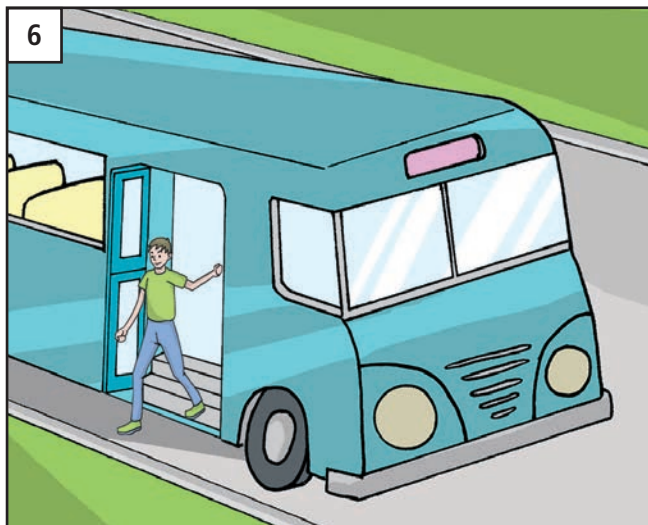

He's getting off the bus.

UNIT 19

1

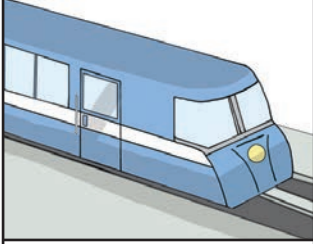

a train

2

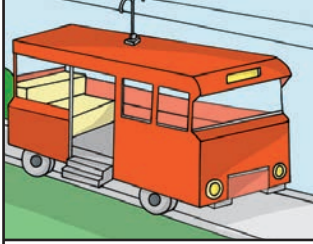

a tram

3



a plane

4



a ferry

5

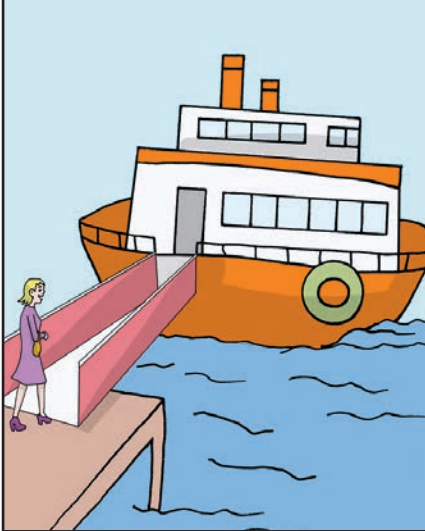

She
the ferry.

6

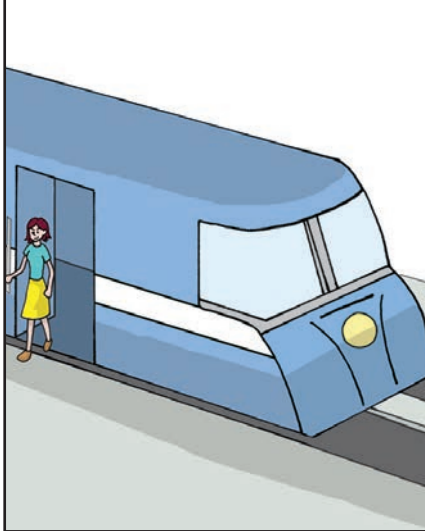

She's getting off
.....

7

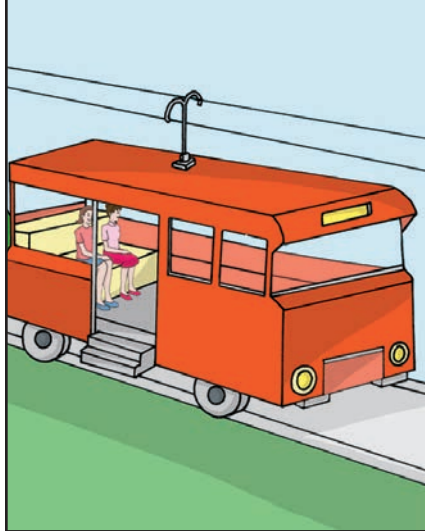

They're
by tram.

8



.....
.....

9

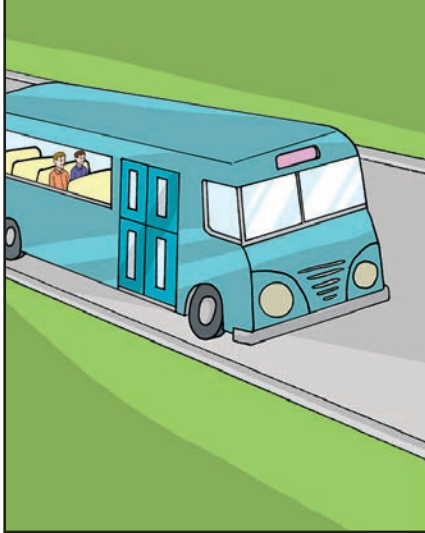

.....
.....

10

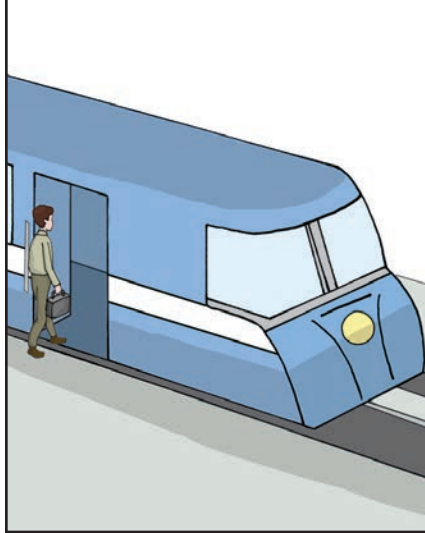

.....
.....

You're not allowed to park here.

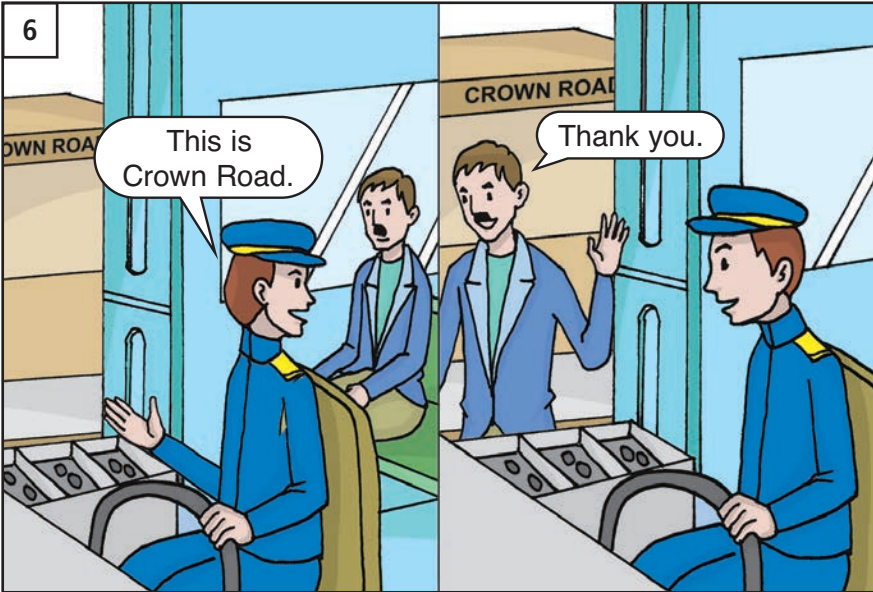
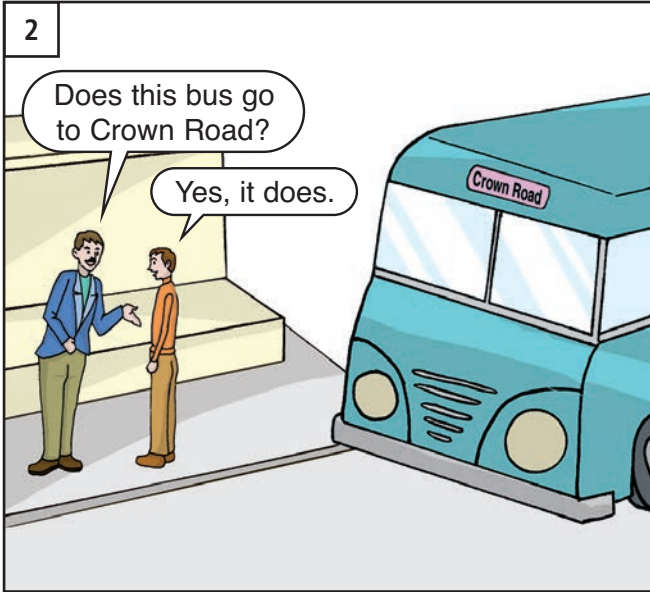
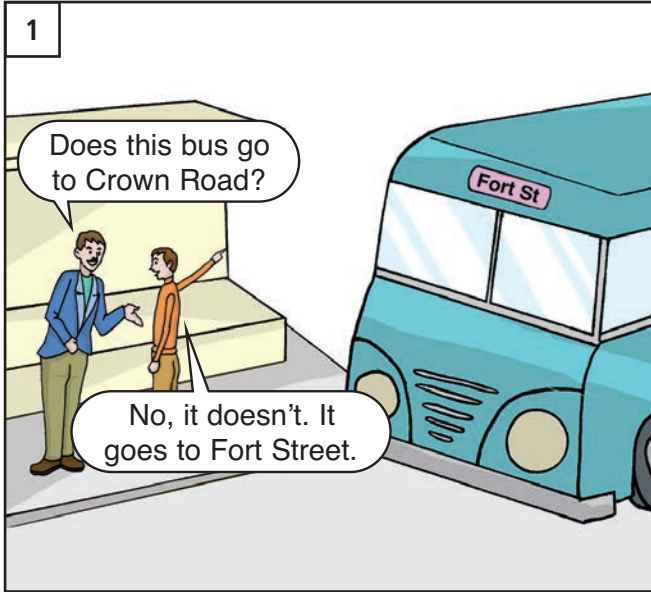

UNIT 19

1

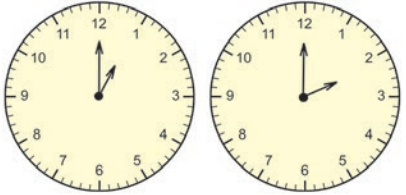

1:00 2:00

one hour

2



The meeting is in one hour.

3



How long will it take?

Two hours.

4

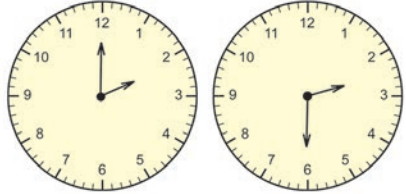

2:00 2:30

half an hour

5

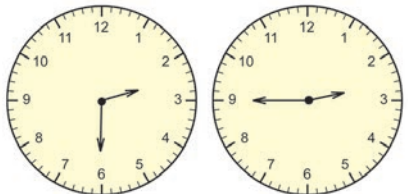

2:30 2:45

quarter of an hour

6



When does the plane for New York leave?

In half an hour.

7

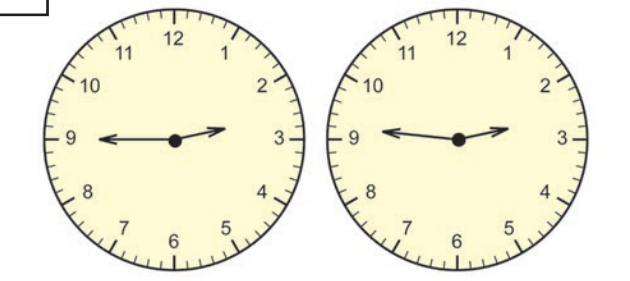

2:45 2:46

one minute

8



The shop opens in three minutes.

OPEN 9:00 A.M.

9

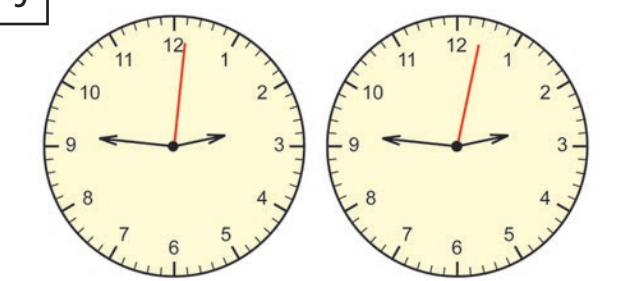

2:46:01 2:46:02

one second

10

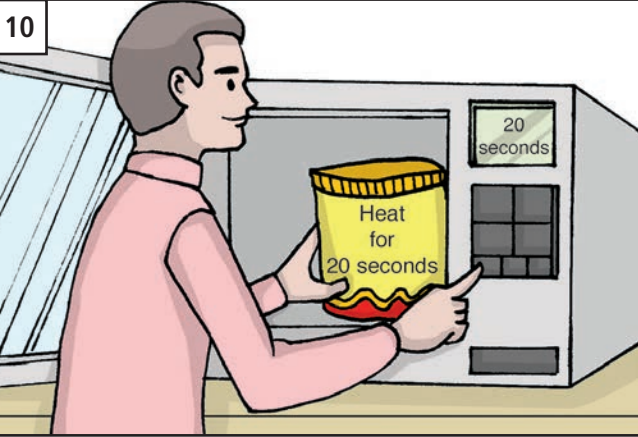

Heat for 20 seconds

20 seconds

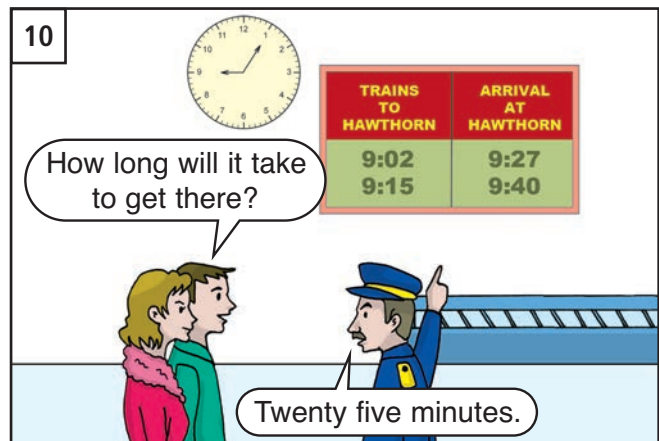
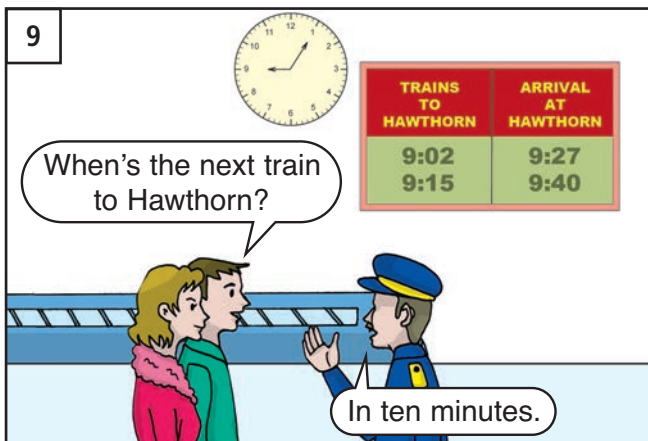
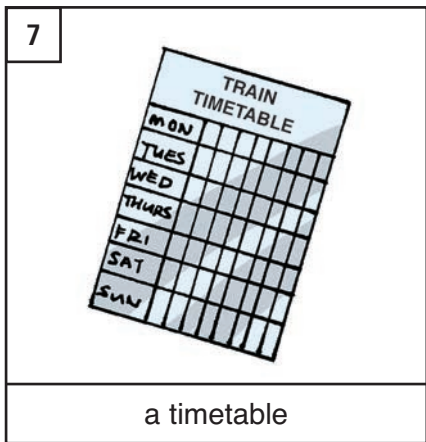
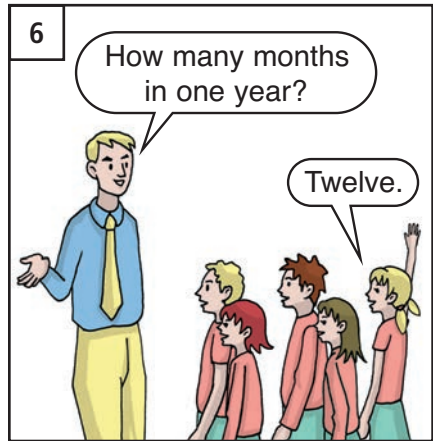
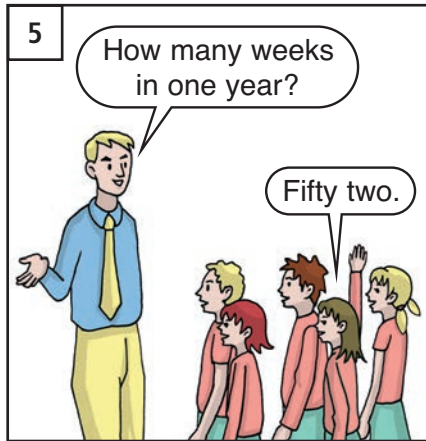
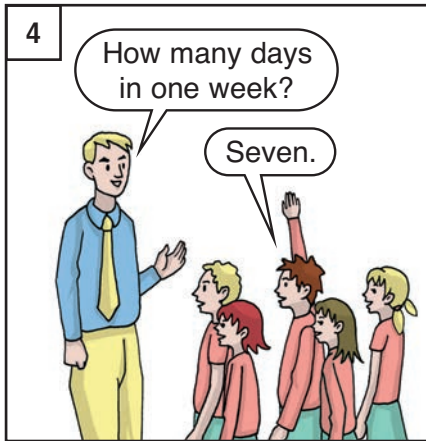
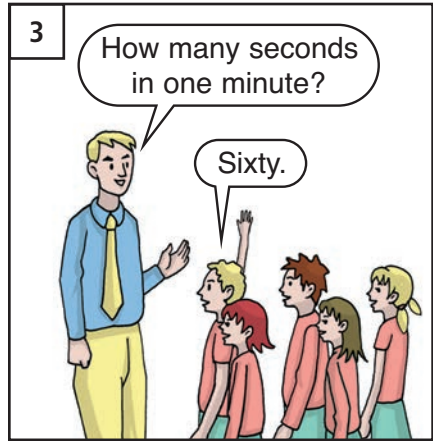
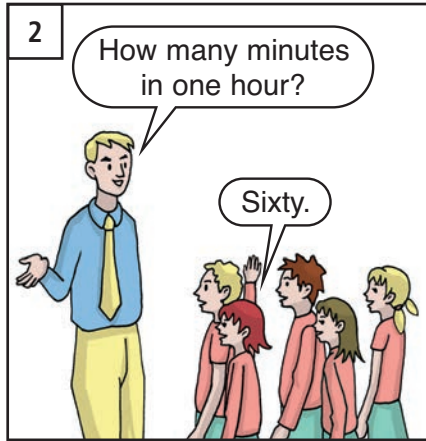
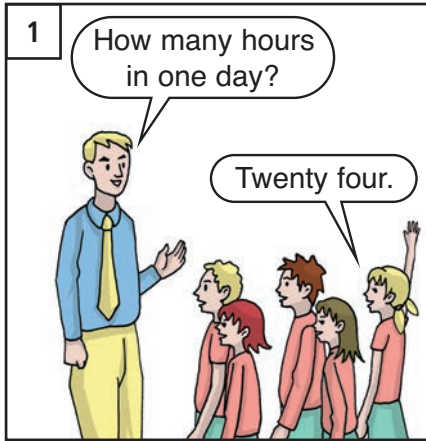

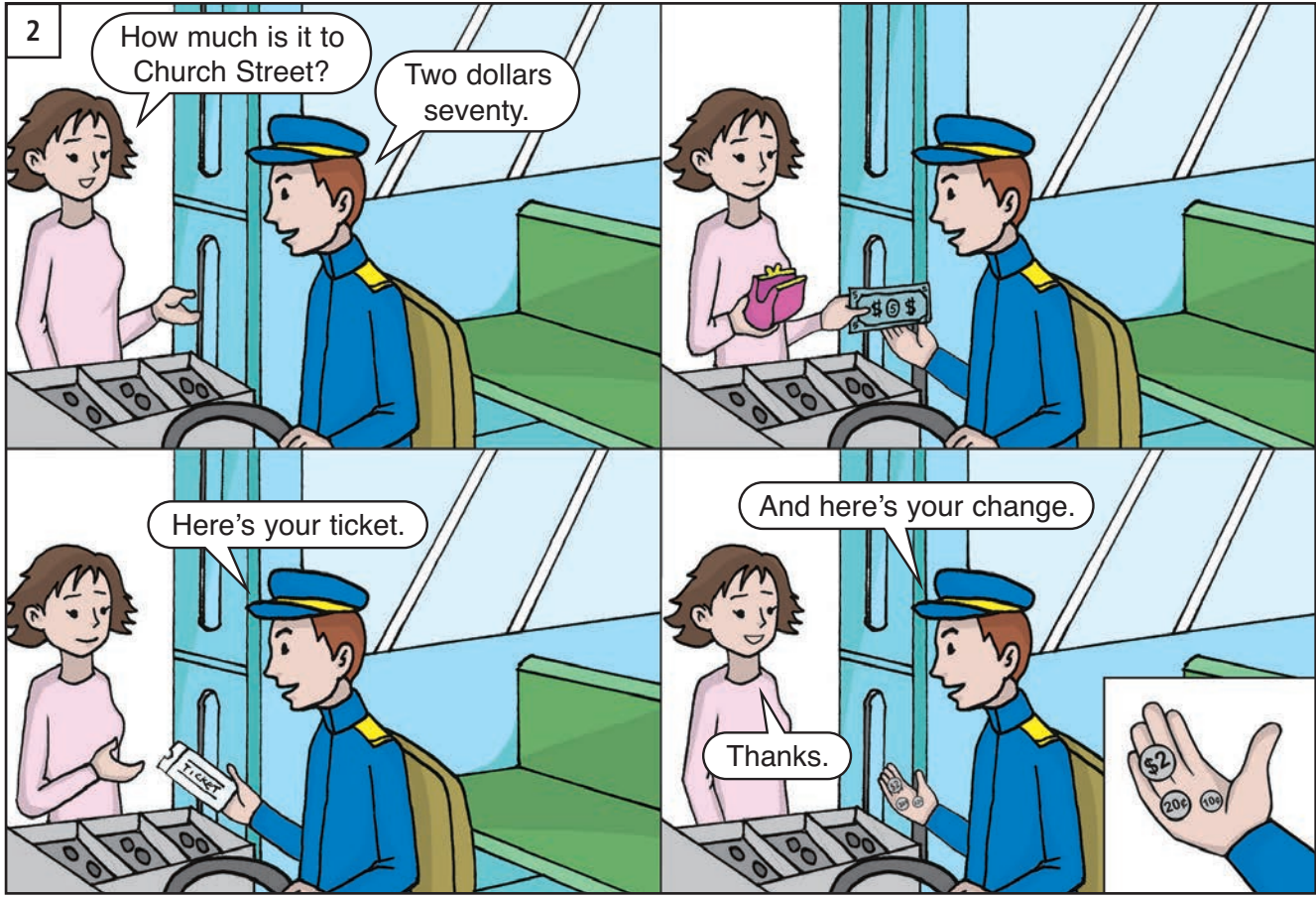
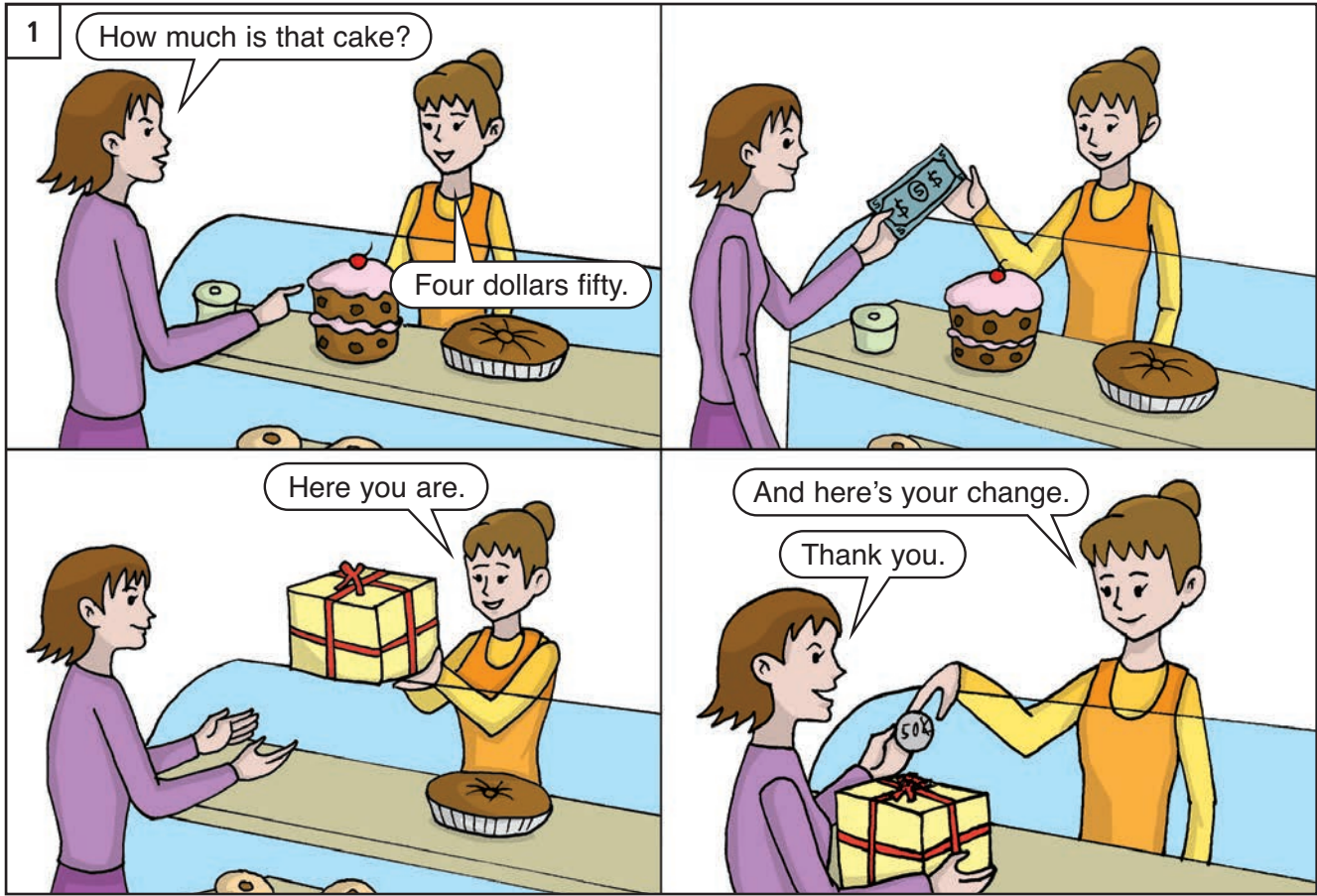

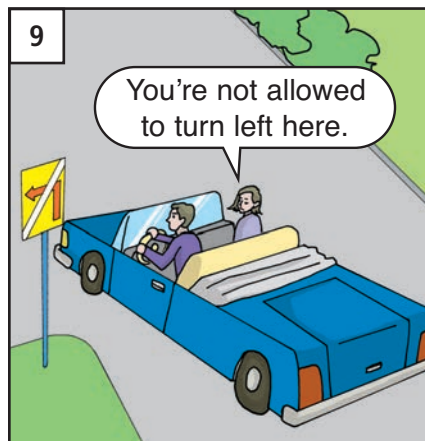
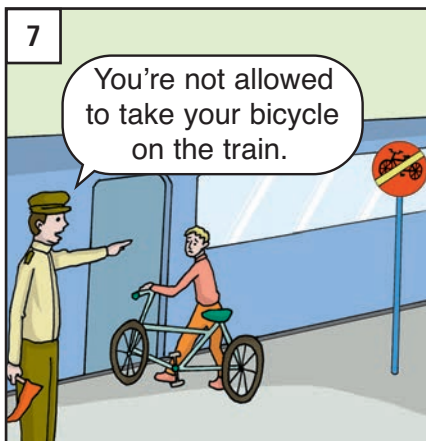
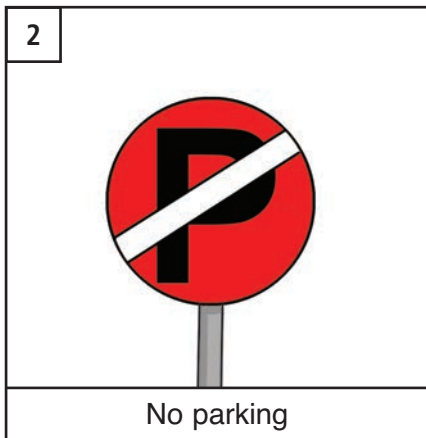
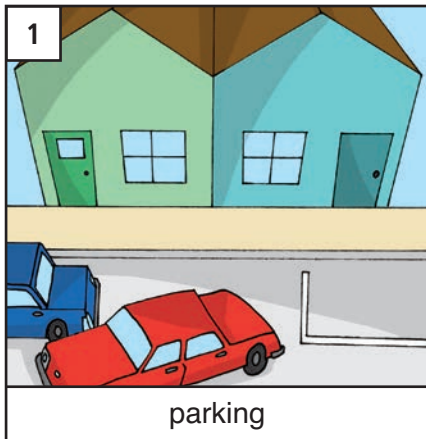

The Bensons

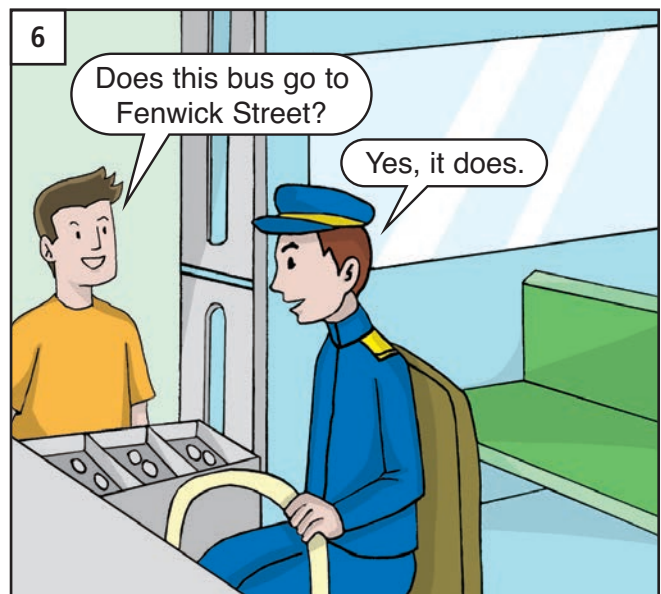
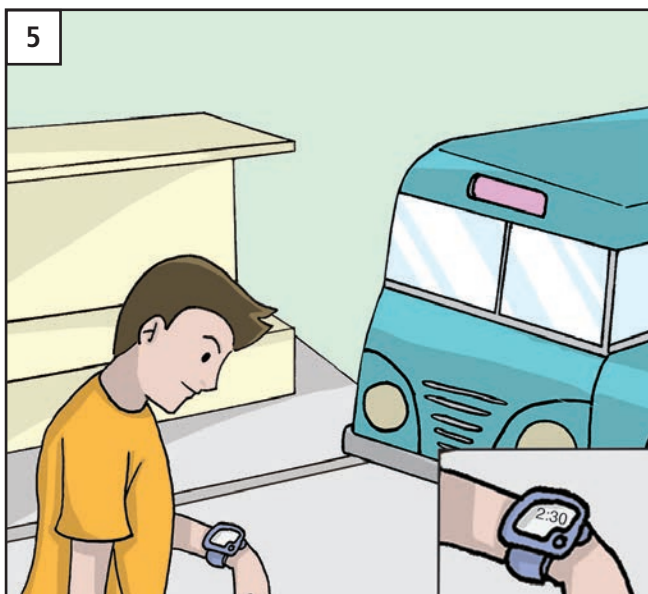
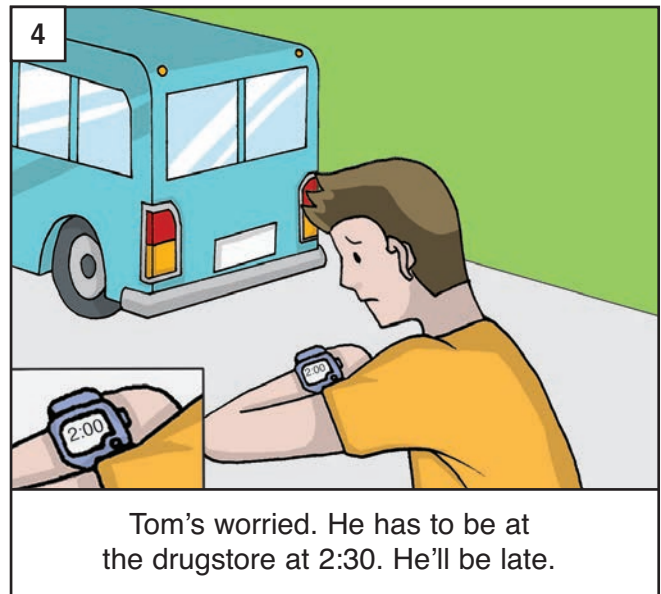
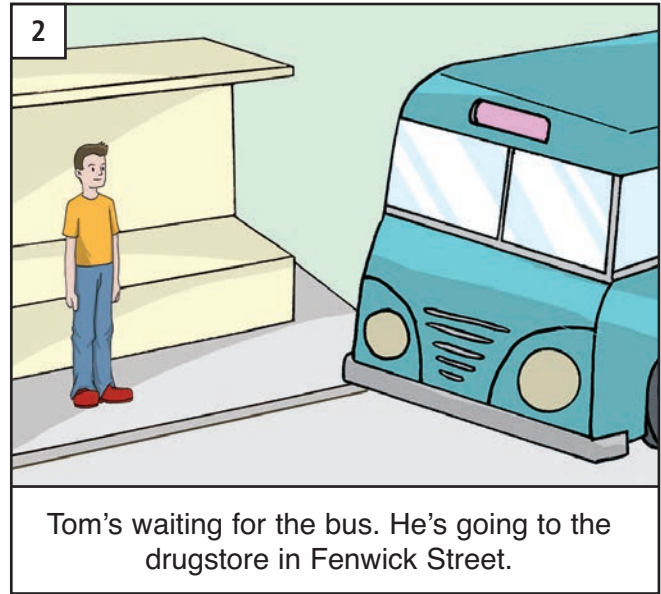

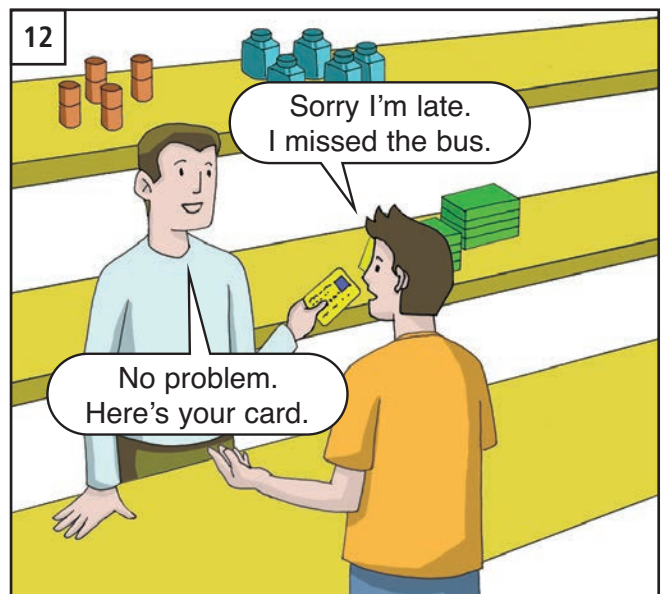
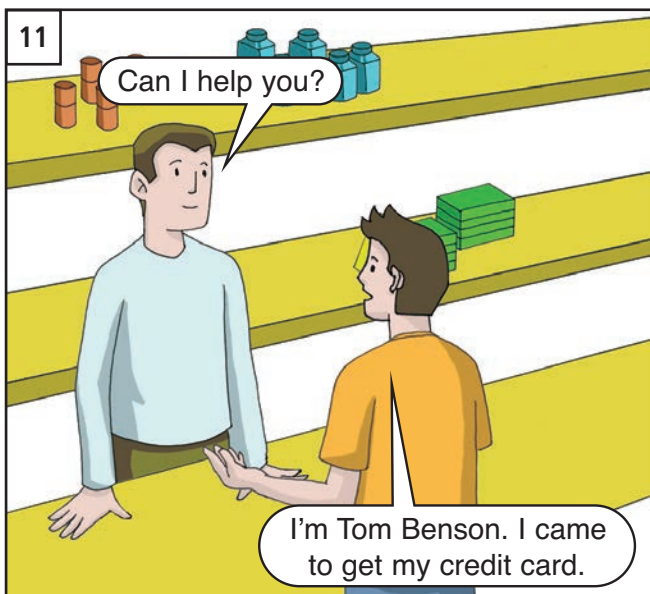

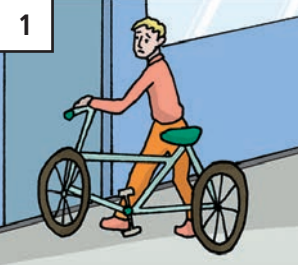

UNIT 20: Revision and extension

1 

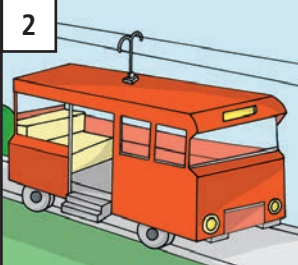
bicycle
.....

2 

.....

3 

.....

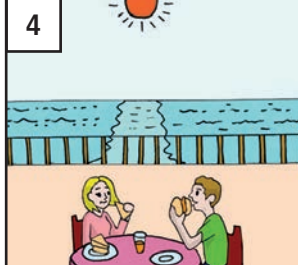
4 

.....

5 

.....

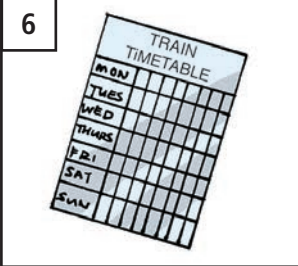
6 

TRAIN TIMETABLE	
MON	
TUES	
WED	
THURS	
FRI	
SAT	
SUN	

.....

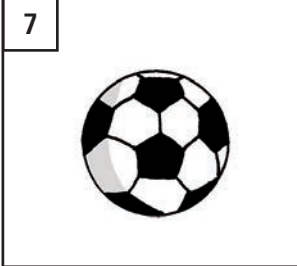
7 

.....

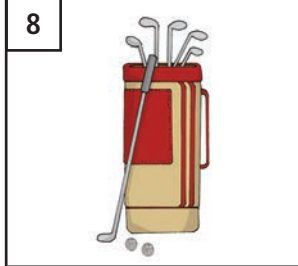
8 

.....

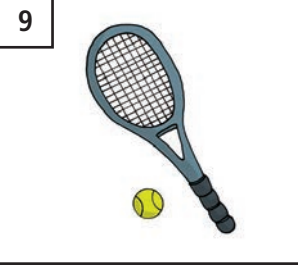
9 

.....

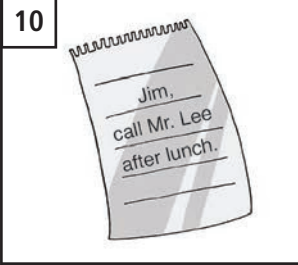
10 

.....

11 

.....

12 

.....

13 

.....

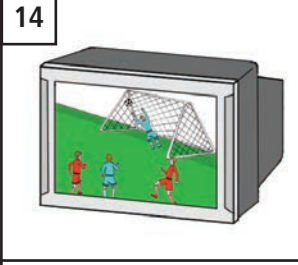
14 

.....

15 

.....

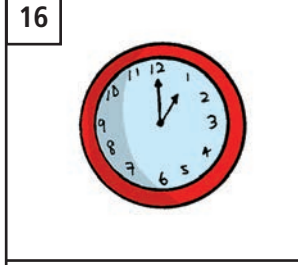
16 

.....

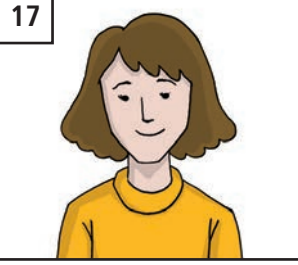
17 

.....

18 

.....

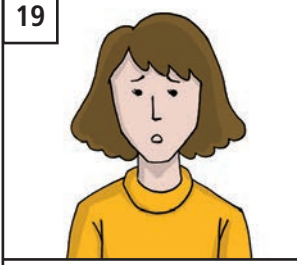
19 

.....

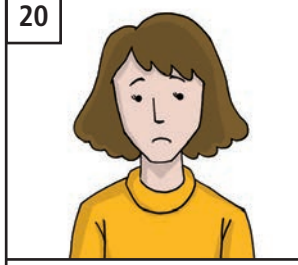
20 

.....

A

- | | |
|--------------------------------|---|
| 1. Can I speak to Sue, please? | a. It's 874298. |
| 2. Who's calling? | b. Sorry, she's busy. Can I take a message? |
| 3. Can I take a message? | c. This is Peter. |
| 4. What's your number? | d. Ask her to call me after lunch, please. |

B

- | | |
|-------------------------------------|------------------------------|
| 1. What's the time? | a. Tomorrow at two o'clock. |
| 2. When's the appointment? | b. Yesterday at two o'clock. |
| 3. When was the meeting? | c. It's two o'clock. |
| 4. You're not allowed to park here. | d. Sorry. I didn't know. |

C

- | | |
|------------------------------------|--------------------------|
| 1. Does this bus go to Crown road? | a. Three dollars twenty. |
| 2. When's the next train? | b. Sure, here you are. |
| 3. How much to Richmond street? | c. At half past four. |
| 4. Have you got a timetable? | d. Yes, it does. |

D

- | | |
|-------------------------------------|---------------------|
| 1. Does she like playing the piano? | a. No, he doesn't. |
| 2. Do you like watching television? | b. Yes, they do. |
| 3. Does he like playing football? | c. No, she doesn't. |
| 4. Do they like shopping? | d. Yes, I do. |

UNIT 20

late message meet past I'll ten leave speaking time

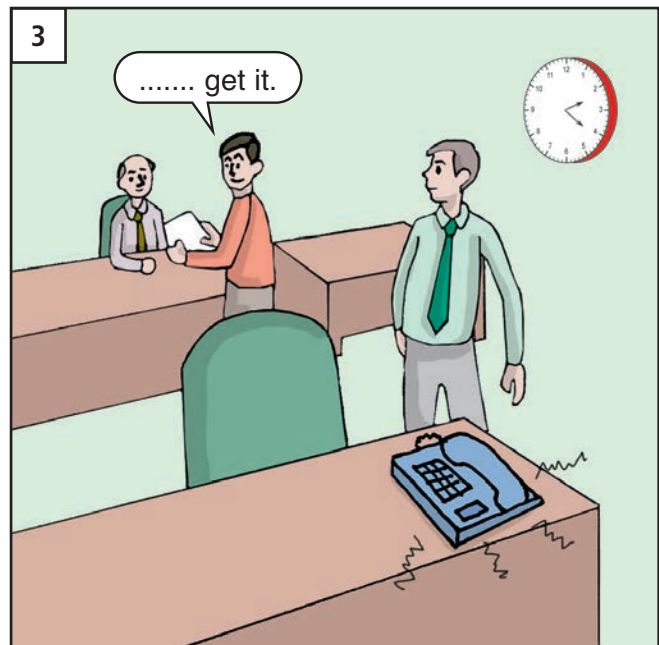
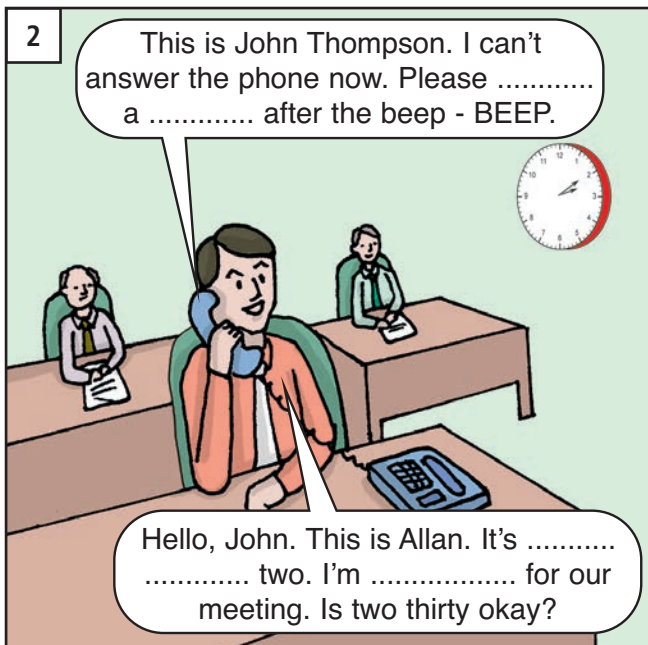
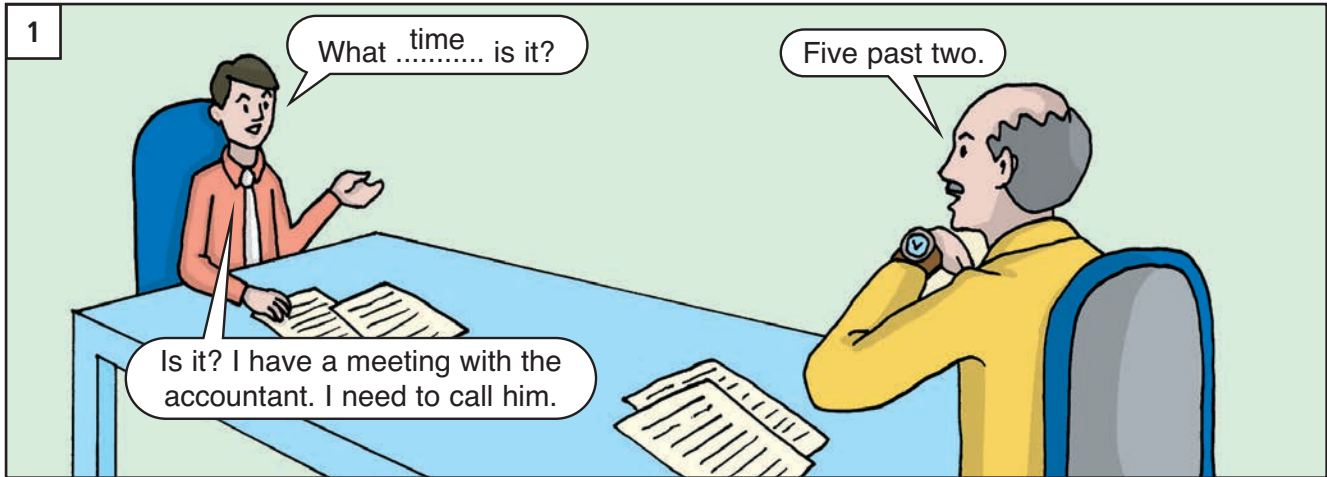

wait

next

In

late

earlier

At

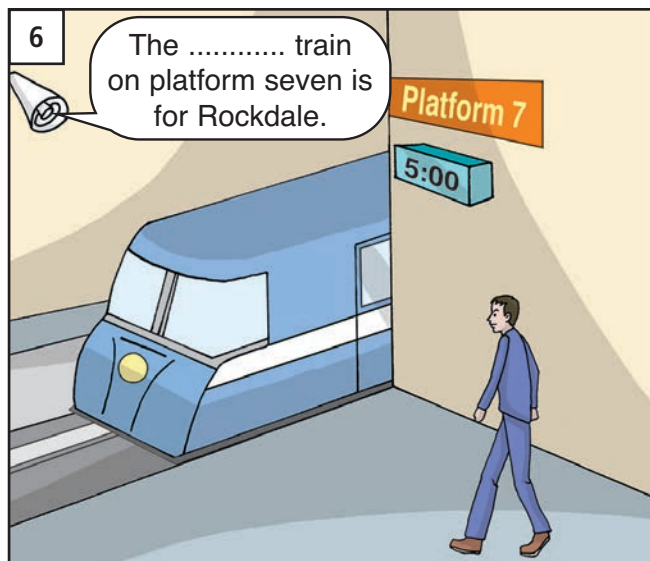

UNIT 20

went ate bought didn't liked thought stayed for

1

You went to Australia last year, you?

Yes, three weeks. It was great.

2

We in Sydney. We saw the Opera House. I it was beautiful.

3

We to the beach in the afternoons.

4

How was the hotel?

Great. We it very much.

5

We at the hotel restaurant every night.

6

We some souvenirs.

lift room key third names like floor open watching

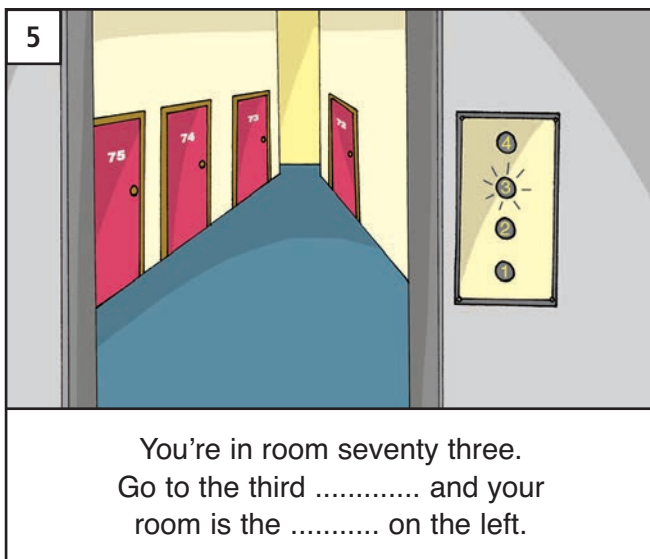
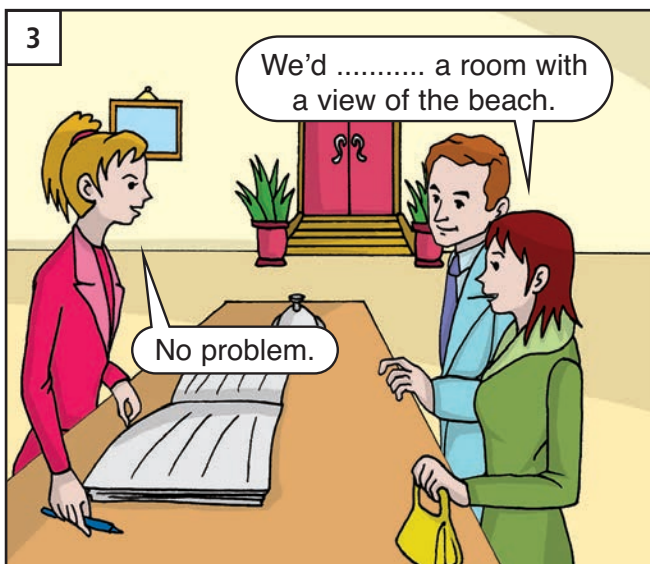

UNIT 20

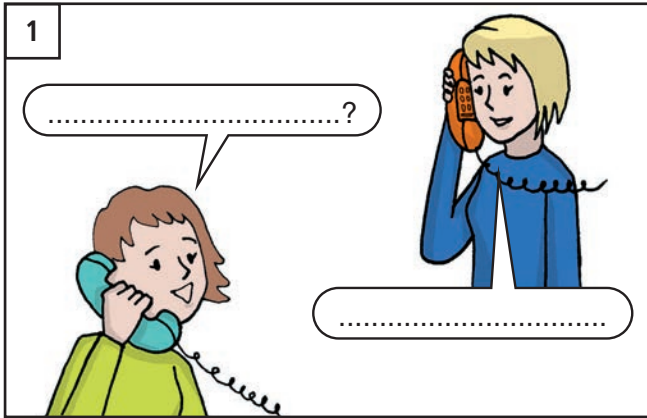

- I speak John Can to
- him get I'll Sure.



- the What's time
- a seven to It's quarter



- is the to next When Rockdale train
- thirty eleven At five

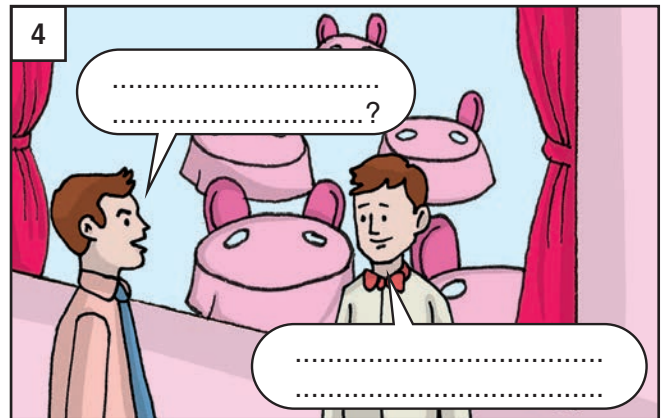

- open restaurant does When the
- this quarter a seven past evening At

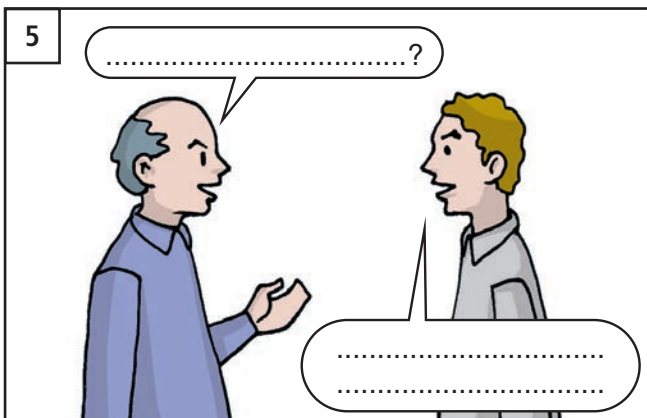

- meeting the When's
- nine morning past At tomorrow half



- arrive When plane the does
- past At half afternoon this two

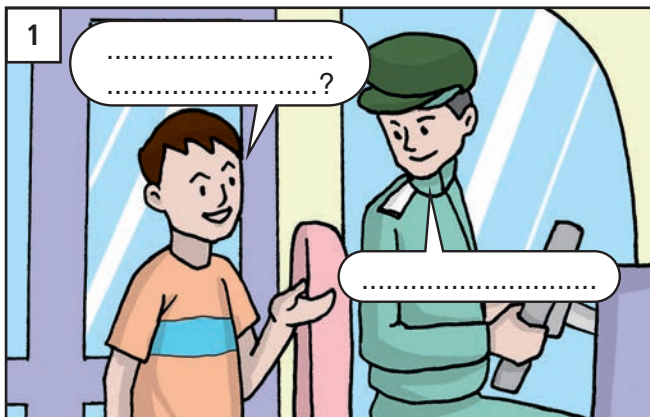

- > bus go Crown Road this Does to
- > does Yes it

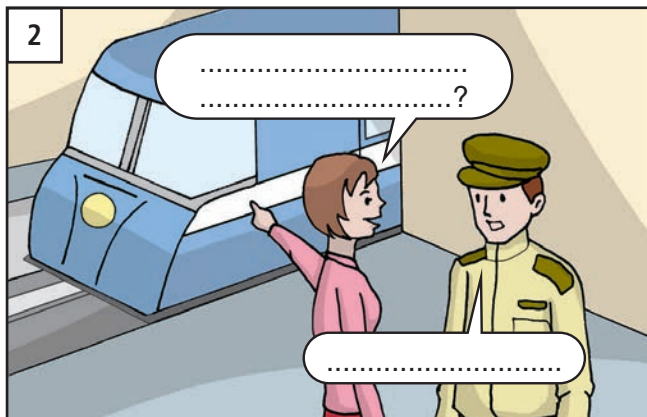

- > this Queenscliff to go Does train
- > doesn't No it

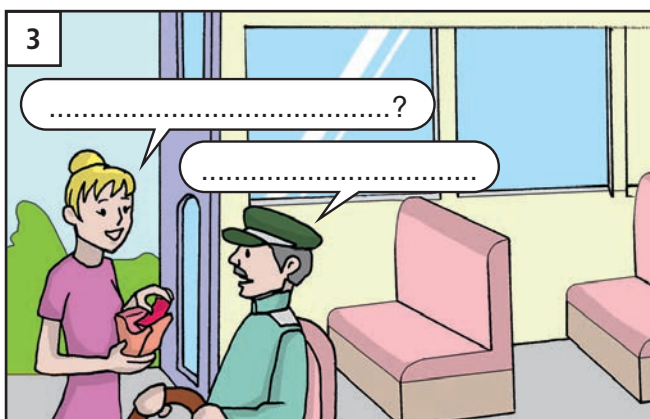

- > to much Kingsfield How it is
- > dollars three It's

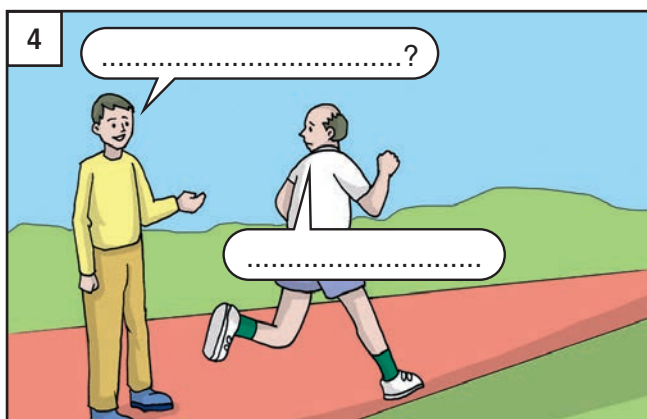

- > running like you Do
- > don't I No



- > driving like you Do
- > I Yes do



- > allowed You are not park here to
- > know I Sorry didn't

UNIT 20: Answers

Unit 20, page 182

- | | | | | |
|---------------|-------------|---------------|----------------|-------------|
| 1. bicycle | 2. tram | 3. breakfast | 4. lunch | 5. dinner |
| 6. timetable | 7. football | 8. golf | 9. tennis | 10. message |
| 11. newspaper | 12. chess | 13. telephone | 14. television | 15. wedding |
| 16. clock | 17. happy | 18. angry | 19. worried | 20. sad |

Unit 20, page 183

- A. 1b 2c 3d 4a B. 1c 2a 3b 4d C. 1d 2c 3a 4b D. 1c 2d 3a 4b

Unit 20, page 184

1. time 2. leave, message, ten, past, late 3. I'll 4. speaking 5. meet

Unit 20, page 185

2. At 3. In 4. earlier 5. late, wait 6. next

Unit 20, page 186

1. didn't, for 2. stayed, thought 3. went 4. liked 5. ate 6. bought

Unit 20, page 187

1. room 2. names 3. like 4. watching 5. floor, third 6. key, open

Unit 20, page 188

1. Can I speak to John?
Sure, I'll get him.
2. What's the time?
It's a quarter to seven.
3. When's the next train to Rockdale?
At eleven thirty five.
4. When does the restaurant open?
At a quarter past seven this evening.
5. When is the meeting?
At half past nine tomorrow morning.
6. When does the plane arrive?
At half past two this afternoon.

Unit 20, page 189

1. Does this bus go to Crown Road?
Yes, it does.
2. Does this train go to Queenscliff?
No, it doesn't.
3. How much is it to Kingsfield?
It's three dollars.
4. Do you like running?
No, I don't.
5. Do you like driving?
Yes, I do.
6. You are not allowed to park here.
Sorry, I didn't know.

Index

a	1	Can you tell me the time	enter	2	his	1
a pair of ...	6	please?	evening	11	horse	9
a.m.	18	Can you tell me when to	everyone	8	hospital	12
accountant	3	get off?	Excuse me.	1	hot	4
address	12	cap	exit	2	hour	19
after	17	car	expensive	9	house	1
afternoon	11	car park	family	1	how about ...?	2
agree	9	card	fast	4	How did you get here?	8
am	2	carrot	father	1	How long ...?	19
angry	18	carton	February	8	How long have you been	
any	13	cash	fence	14	here?	8
apple	6	cauliflower	fifteen	8	How many ... do you have?	7
application form	7	ceiling	fifth	14	How many?	6
appointment	18	cent	fifty	12	How much ...	8
April	8	change	first	14	How's your ... now?	13
are	2	cheap	fit	4	hurt	11
Are you all right?	11	chess	five	6	husband	1
aren't	4	child	flight	18	I	2
arm	11	chips	floor	13	I don't know.	1
around the corner	12	cinema	foot	11	I live at ...	12
arrive	8	clean	football	17	I'd like ...	3
art gallery	2	clock	for	8	I'd like you to meet ...	3
ask	17	close	forty	12	I'd love to but I can't.	2
at	12	coffee	four	6	I'd love to.	2
August	8	cold	fourteen	8	I'll	12
baby	4	colleague	fourth	14	I'll get it	17
back	11	come	Friday	8	I'm a ...	7
backache	11	concert	friend	3	I'm afraid I can't.	2
bad	9	cookie	from	7	I'm from ...	8
bag	6	corner	full	17	I'm sorry to hear that.	11
banana	6	Could you repeat that	garden	17	I'm sorry.	7
bank	14	please?	gas station	14	I've been here for ...	8
basketball player	9	credit card	get	12	ice cream	9
beach	2	cucumber	get off	19	in	2
beans	9	cup of ...	get on	19	interesting	9
beautiful	4	cute	glass of ...	6	is	1
beep	17	Dad	go	2	isn't	1
before	14, 17	daughter	go home	11	it	1
big	9	day	golf	17	it's	1
bill	11	December	good	4, 9	It's all right.	4
black	14	did	Good afternoon.	11	January	8
blue	14	dinner	Good evening.	11	jockey	9
book	1	dirty	Good morning.	11	juice	6
boring	9	do	Good night.	11	July	8
bottle of	6	Do you have ...?	Good to meet you.	3	June	8
box	13	Do you like ...?	great	4	Keep right.	11
bread	9	Do you take ...?	green	14	key	1
breakfast	17	doctor	guitar	13	knee	11
bring	2	does	hair	17	know	2
broccoli	9	Does this bus go to ...?	half	18	laptop	1
brother	1	doesn't	hand	11	late	18
brown	14	dollar	happy	18	leave	8
burger	6	don't	have	7	leave a message	17
bus	8	door	have a haircut	17	left	14
bus stop	14	drink	Have a nice day.	11	leg	11
businessman	7	drive	have to	11	let's	2
busy	17	drugstore	Have you met ...?	3	lettuce	9
but	2	ear	he	2	light	9
buy	16	earache	head	11	like	9
by	8	early	headache	11	long	17
Bye.	11	eat	heat	19	looks good	4
cabbage	9	egg	heavy	9	looks like	3
cake	6	eight	hello	7	lovely	4
call	12	eighteen	her	1	lunch	2, 17
camera	1	eighth	here	3	make	13
can	2	eighty	Here you are.	19	March	8
Can I help you?	9	eleven	Hi	3	market	2
can of ...	6	empty	him	2	May	8

me	2	pen	1	stomachache	11	twenty-four	12
mechanic	7	pharmacist	7	stop	11	twenty-nine	12
meet	3	phone	17	straight ahead	14	twenty-one	12
meeting	2	piano	13	street	12	twenty-seven	12
message	17	picnic	2	sugar	6	twenty-six	12
met	3	piece of ...	6	suitcase	9	twenty-three	12
milk	6	plane	4	sun	11	twenty-two	12
mine	4	play	4, 13	Sunday	8	two	6
minute	19	please	17	supermarket	14	two hundred and one	12
miss	19	plum	6	sure	2	us	2
mobile phone	1	police officer	7	surfboard	9	use	19
Mom	16	police station	12	swim	17	very	9
Monday	8	post office	14	tablet	6	very much	9
month	8	potatoes	9	take	2	view	4
moon	11	pull	16	take a message	17	violin	13
morning	11	purse	1	talk	16	wait	13
mother	1	push	16	tall	9	waiting room	13
movies	2	quarter	18	taxi driver	7	wall	13
mushroom	9	railway station	14	taxi rank	14	wallet	1
my	1	read	17	tea	6	was	7, 16
My name's ...	1	receptionist	7	teach	16	wash	16
name	1	red	14	teacher	3	watch	1, 17
narrow	9	restaurant	2	telephone	17	watch	17
near	12	rice	9	television	17	water	6
need	13	right	14	ten	6	we	2
neighbor	3	road	12	tennis	17	wedding	18
new	13	roof	14	tenth	14	Wednesday	8
newspaper	17	room	13	Thank you.	1	week	8
next door	12	run	4	Thanks for coming.	11	weekend	8
next to	12	sad	18	that	3	welcome	18
night	11	sales assistant	7	That'd be great.	2	well	4
nine	6	sandwich	6	That's OK	13	were	3, 16
nineteen	8	Saturday	8	the	1	wet	4
ninety	12	sausage	6	theater	2	what	1
ninth	14	school	8	their	1	What do you do?	7
no	1	seat	4	them	2	What do you think?	9
No parking.	19	second	14, 19	there	3	What would you like?	6
No problem.	13	secretary	3	these	3	What's the matter?	11
No, I haven't.	3	See you later.	11	they	2	What's the time?	18
No, thanks.	6	sell	16	think	9	What's wrong?	11
not	4	September	8	third	14	What's your address?	12
November	8	seven	6	thirteen	8	What's your name?	1
now	7	seventeen	8	thirty	12	when	7
number	17	seventh	14	thirty-one	12	where	7
nurse	7	seventy	12	this	1	Where are you from?	8
nuts	6	she	2	this is ...	1	Where do you live?	12
o'clock	18	shoe	4	those	3	white	14
occupation	7	shop	17	three	6	who	2
October	8	short	9, 17	Thursday	8	Who's calling?	17
OK	2	shoulder	11	ticket	6	whose	1
old	13	since	8	timetable	19	wide	9
on	12	sister	1	to	2, 7	wife	1
one	6	sit	4	today	18	will	12
one hundred	12	six	6	toilet	14	window	13
onion	9	sixteen	8	tomato	9	with	14
open	16	sixth	14	tomorrow	18	work	4, 17
opposite	12	sixty	12	too	7	worried	18
or	13	sleep	16	tooth	11	... would be nice.	6
orange	6, 14	slowly	7	toothache	11	Would you like to come	
our	1	small	9	toothbrush	13	to ...?	2
out	2	sock	6	toothpaste	13	Would you like ...?	6
p.m.	18	some	6	tour guide	7	write	16
pair of sunglasses	9	something to drink	6	traffic lights	14	year	8
pants	9	something to eat	6	train	8	yellow	14
park	19	son	1	trumpet	13	yes	1
party	2	Sorry, I can't.	2	tube	13	Yes, please.	6
past	14	Sorry.	11	Tuesday	8	yesterday	18
pasta	9	speak	17	turn	14	you	2
pay	11	stadium	14	twelve	8	You should ...	13
peach	6	stars	11	twenty	8	You're not allowed to ...	9
pear	6	still	8	twenty-eight	12	your	1
peas	9	stomach	11	twenty-five	12	yours	4

Other books of interest from Tuttle Publishing

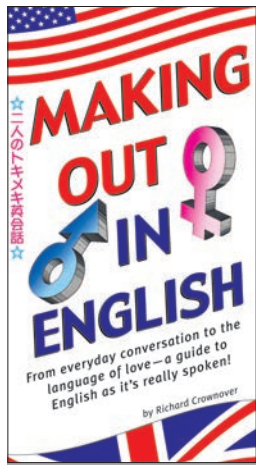

ISBN 978-0-8048-3681-4

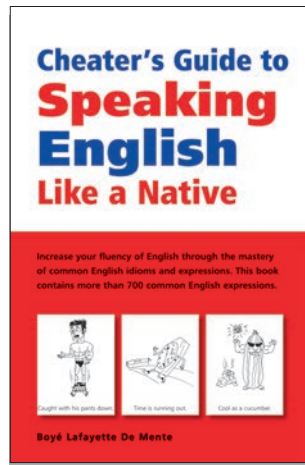

ISBN 978-0-8048-3682-1



ISBN 978-0-8048-3745-3

Other Ebooks Available

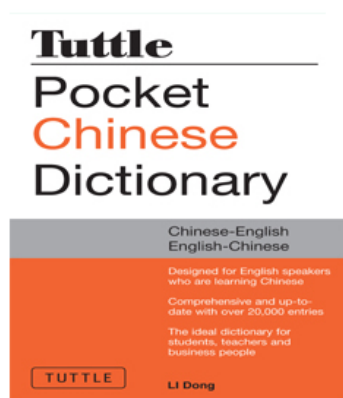

ISBN: 978-1-4629-1090-8

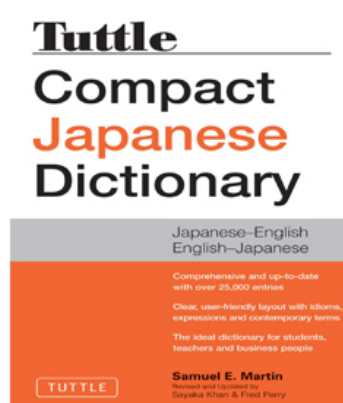

ISBN: 978-1-4629-1082-3

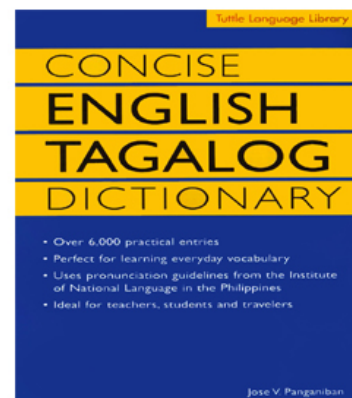

ISBN: 978-1-4629-1128-8

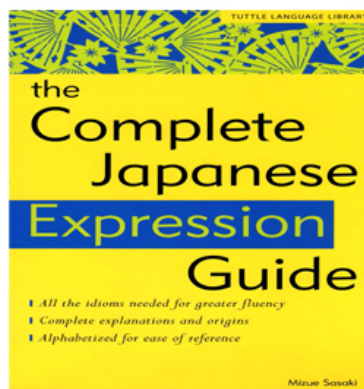

ISBN: 978-1-4629-0469-3



ISBN: 978-1-4629-0981-0

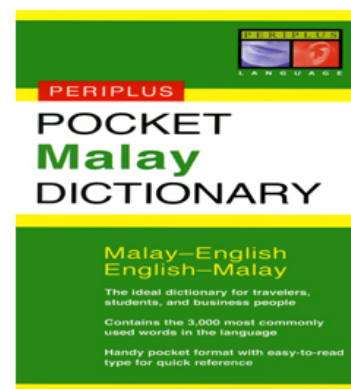

ISBN: 978-1-4629-0982-7

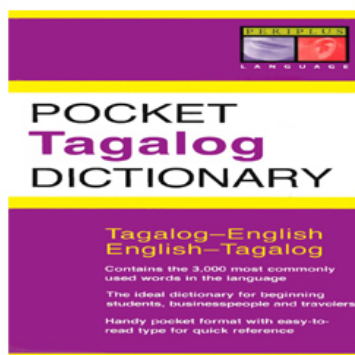

ISBN: 978-1-4629-0983-4

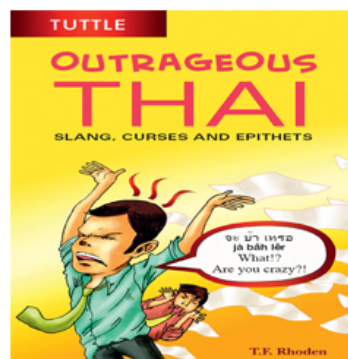

ISBN: 978-1-4629-1031-1



ISBN: 978-1-4629-1057-1

English Made Easy is a breakthrough in English language learning—imaginatively exploiting how pictures and text can work together to create understanding and help learners learn more productively. It gives learners easy access to the vocabulary, grammar and functions of English as it is actually used in a comprehensive range of social situations. Self-guided students and classroom learners alike will be delighted by the way they are helped to progress easily from one unit to the next, using a combination of pictures and text to discover for themselves how English works. The pictorial method used in this book is based on a thorough understanding of language structure and how language is successfully learned. The authors are experienced English language teachers with strong backgrounds in language analysis and language learning.

English Made Easy: Learning English through Pictures Volume 1 consists of a total of 20 units arranged in groups of five. The first four units present language and provide learners the opportunities to practice as they learn. The first page of each unit has a list of all the words and phrases to be learned in that unit, together with a pronunciation guide. At the end of each unit, an interesting story which uses the language that has just been learned is presented. The fifth unit in each group contains exercises designed to reinforce the language learned in the first four units.

TUTTLE

www.tuttlepublishing.com

Printed in Singapore

ISBN 978-1-4629-0557-7



51995
9 781462 905577 US \$19.95