

Dot to Dot

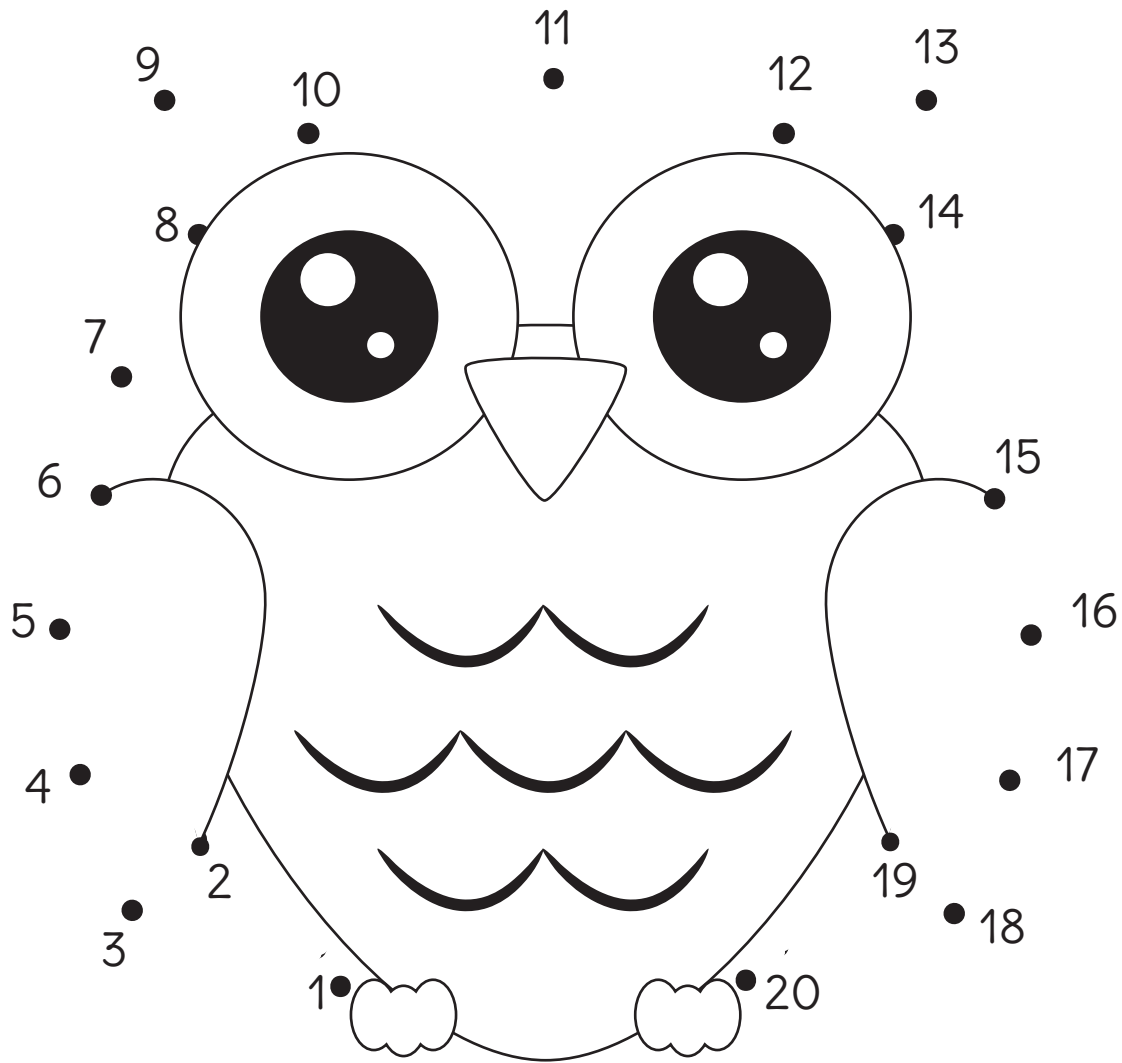

Dot to Dot

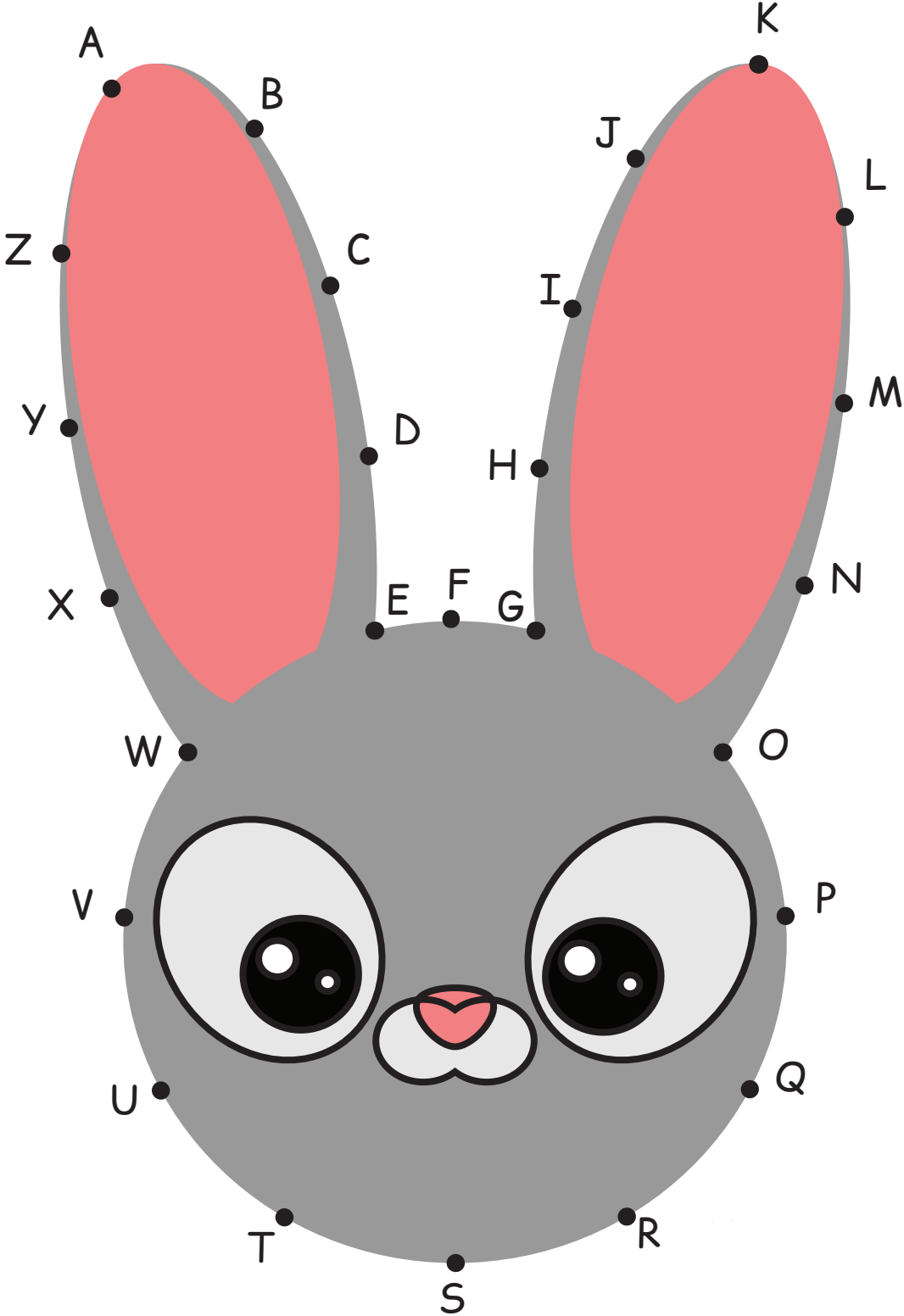

Dot to Dot

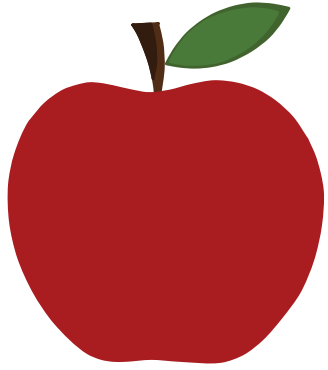
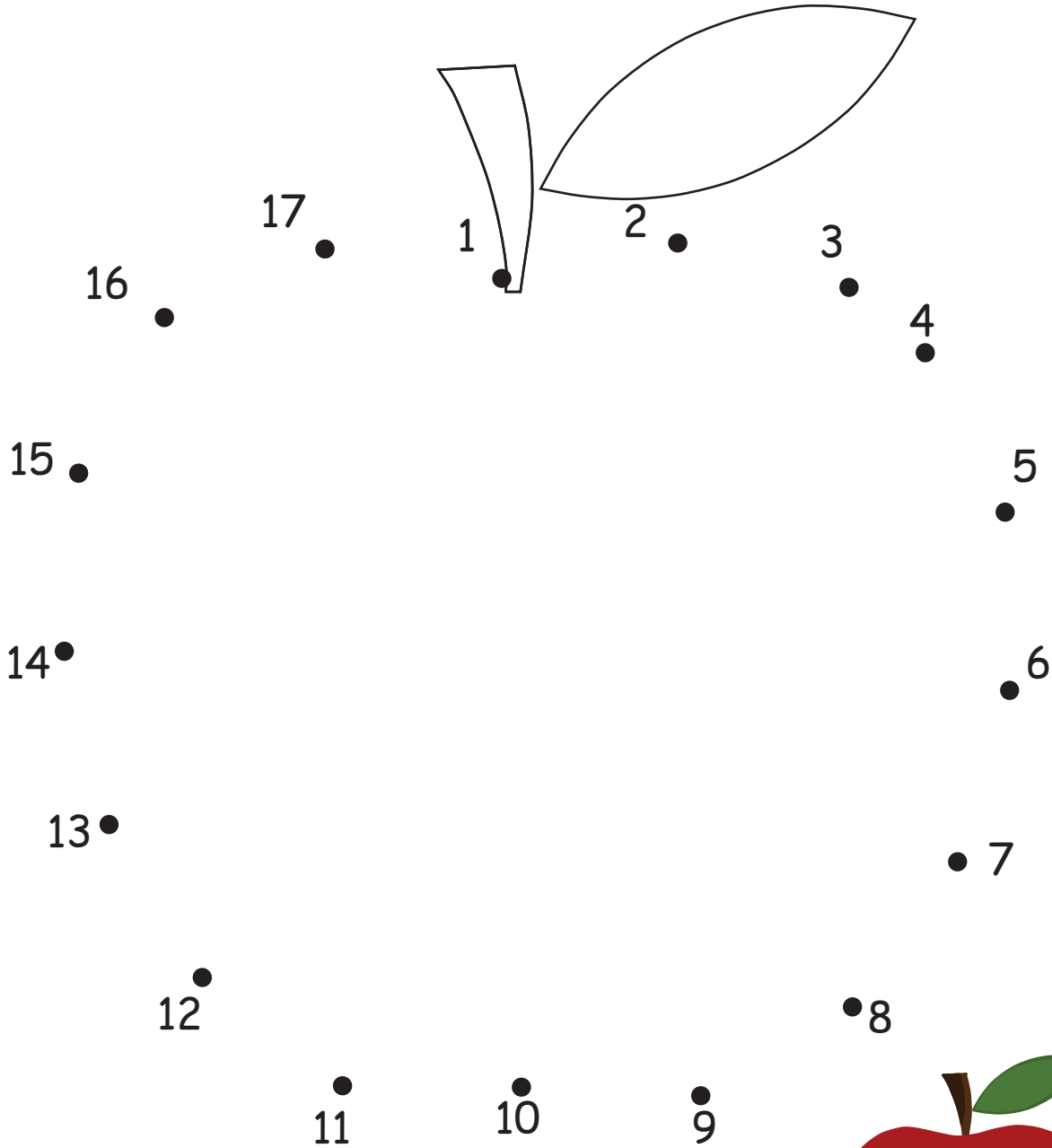

Dot to Dot

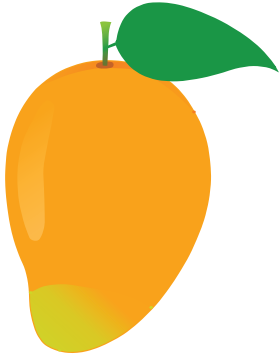
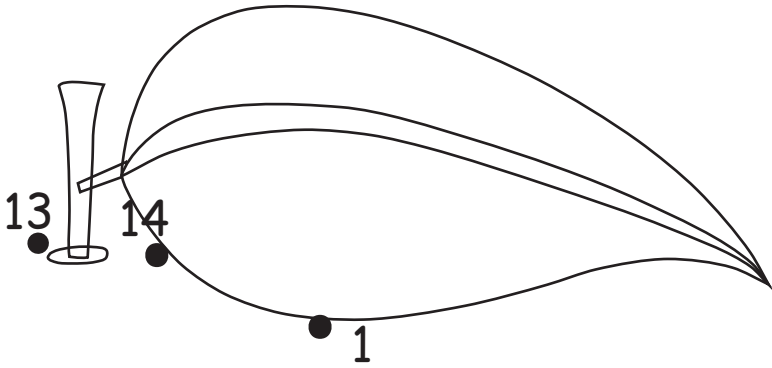

Dot to Dot

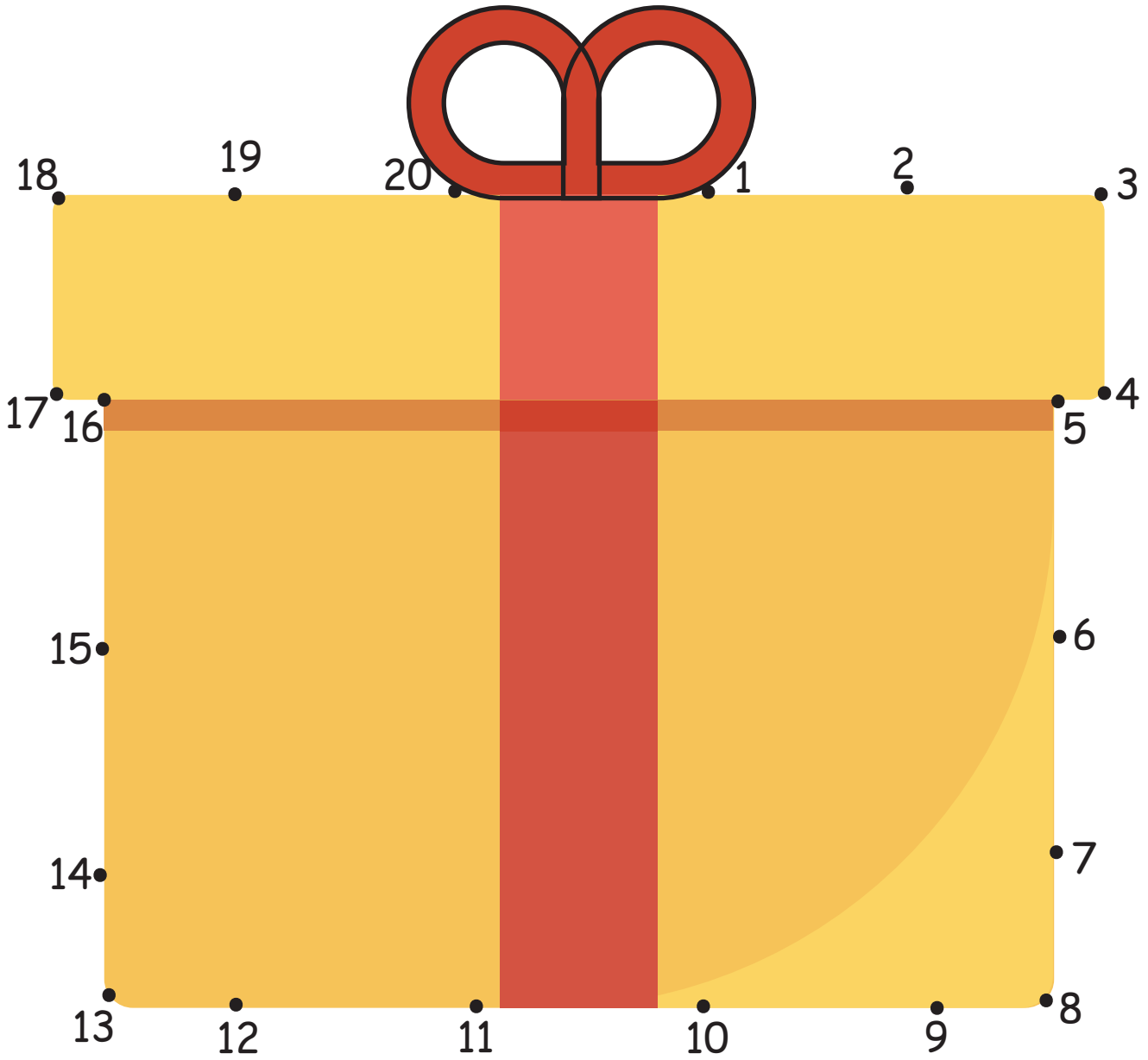

Dot to Dot

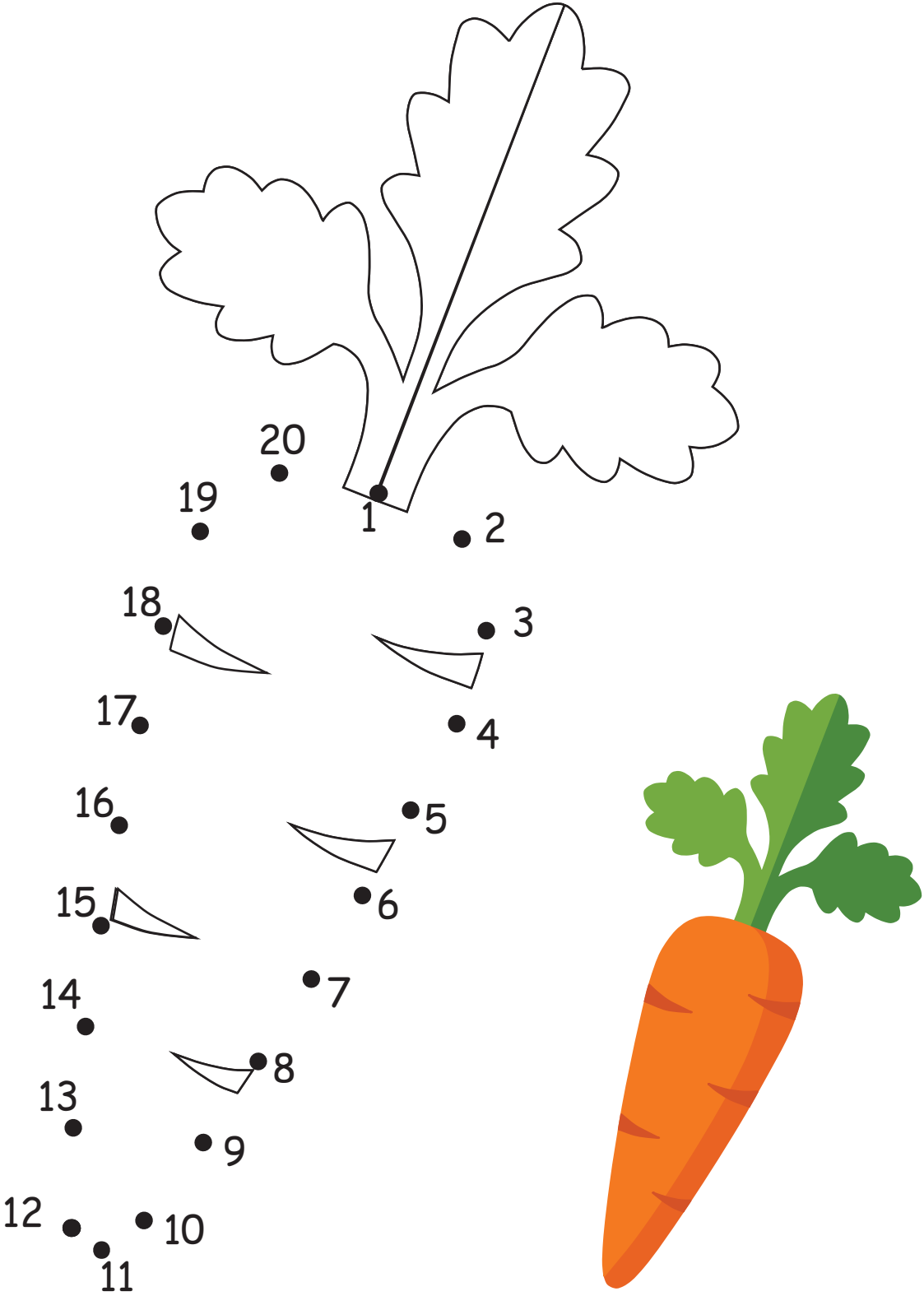

Dot to Dot

A dot-to-dot puzzle of a fish. The puzzle is partially completed with solid lines. The remaining parts are indicated by letters A through Z, each with a small black dot next to it. The letters are: A (top left), B and C (top middle), D, E, F (top right), G and H (far top right), I (middle right), J, K, L (far right), M (middle right), N (middle right), O (middle right), P (bottom middle), Q (bottom middle), R (bottom middle), S (bottom middle), T (bottom middle), U (bottom middle), V (bottom middle), W (bottom middle), X (bottom middle), Y (bottom middle), Z (bottom middle).

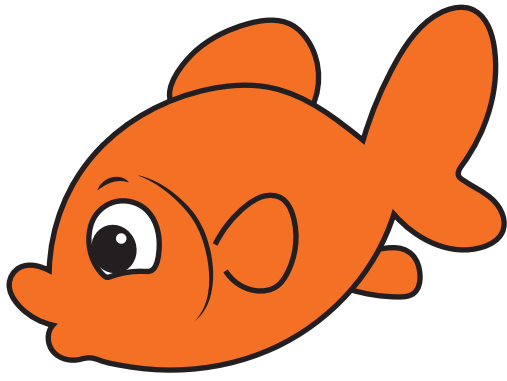

Dot to Dot

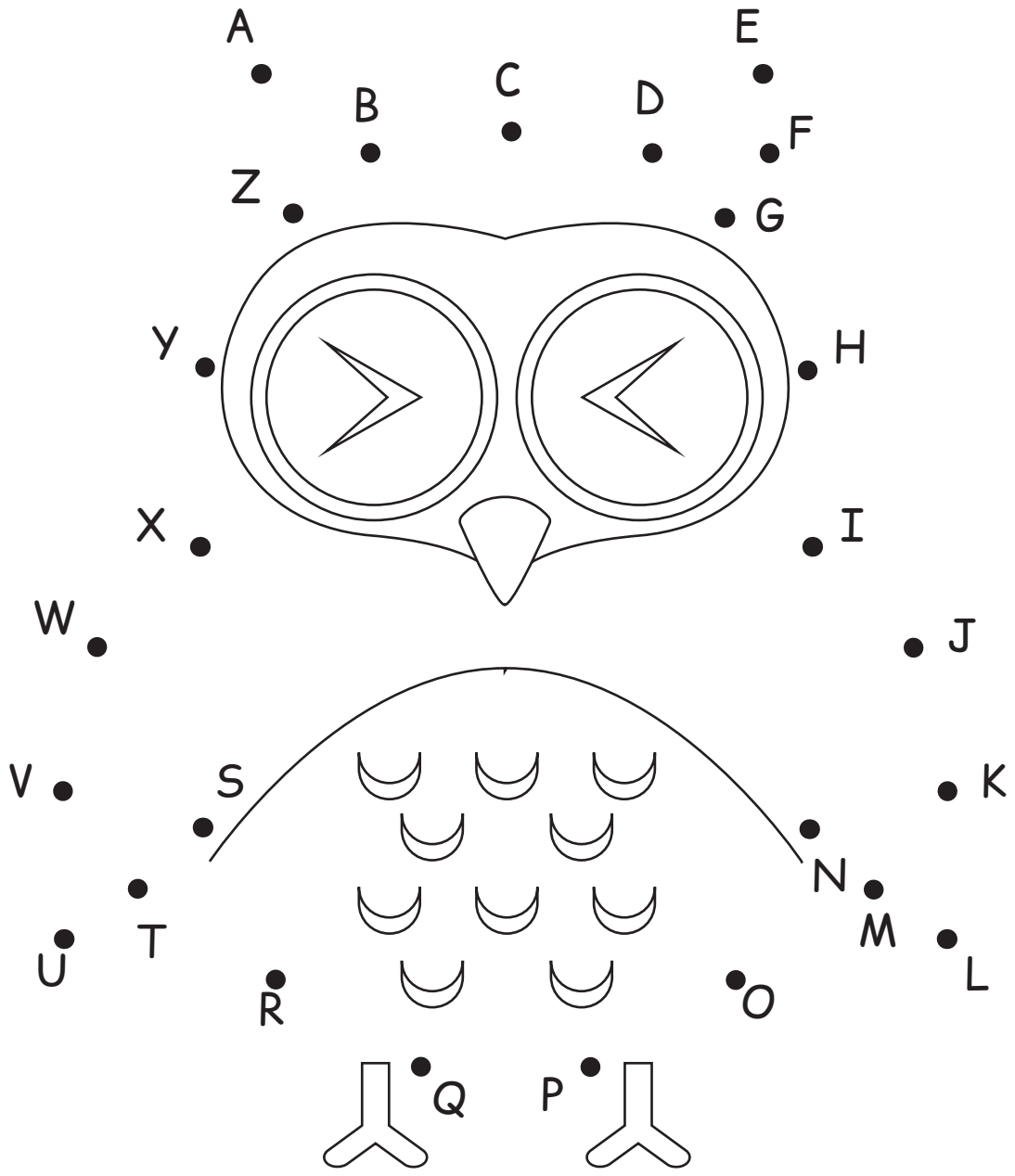

Dot to Dot

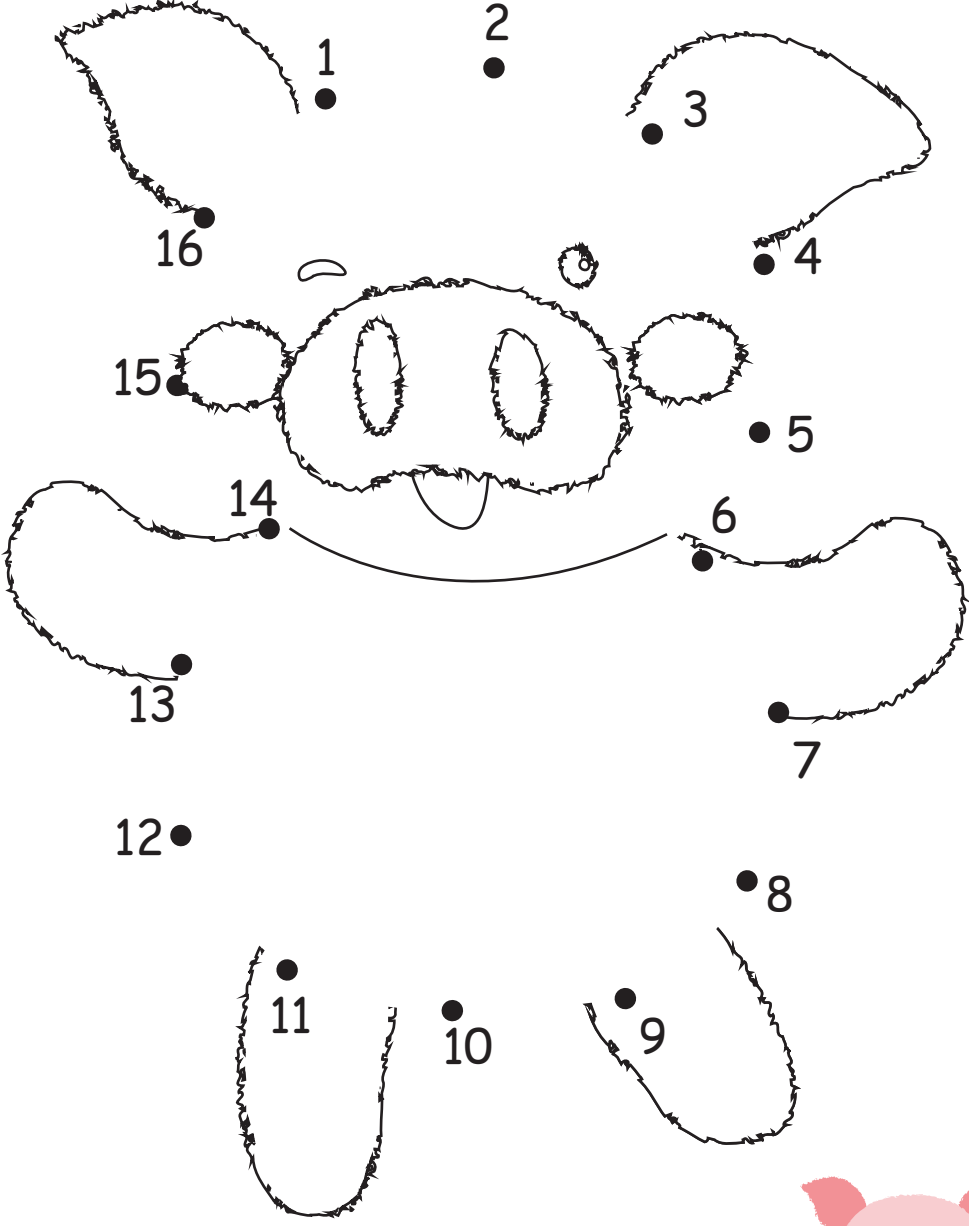

Dot to Dot

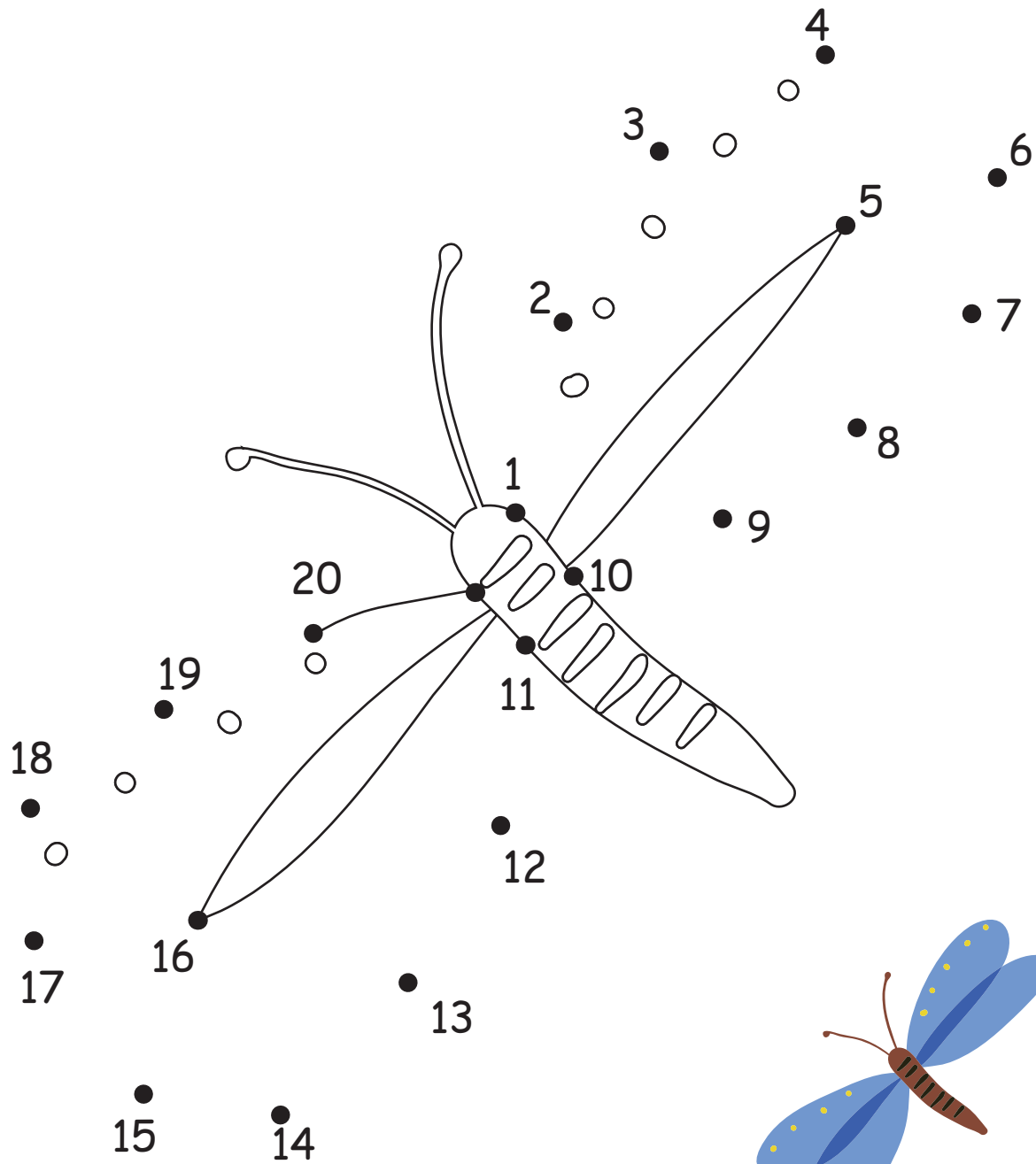

Dot to Dot

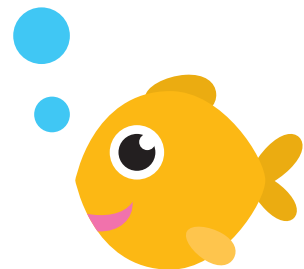
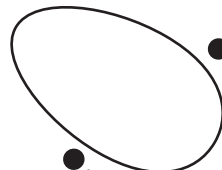
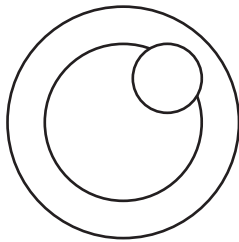
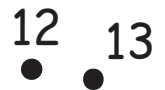
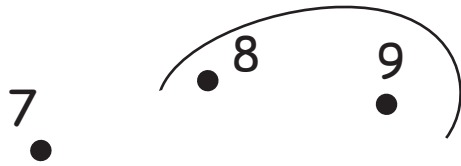
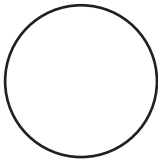
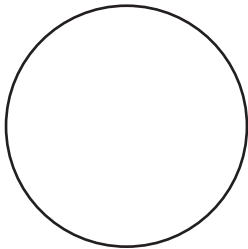

Dot to Dot

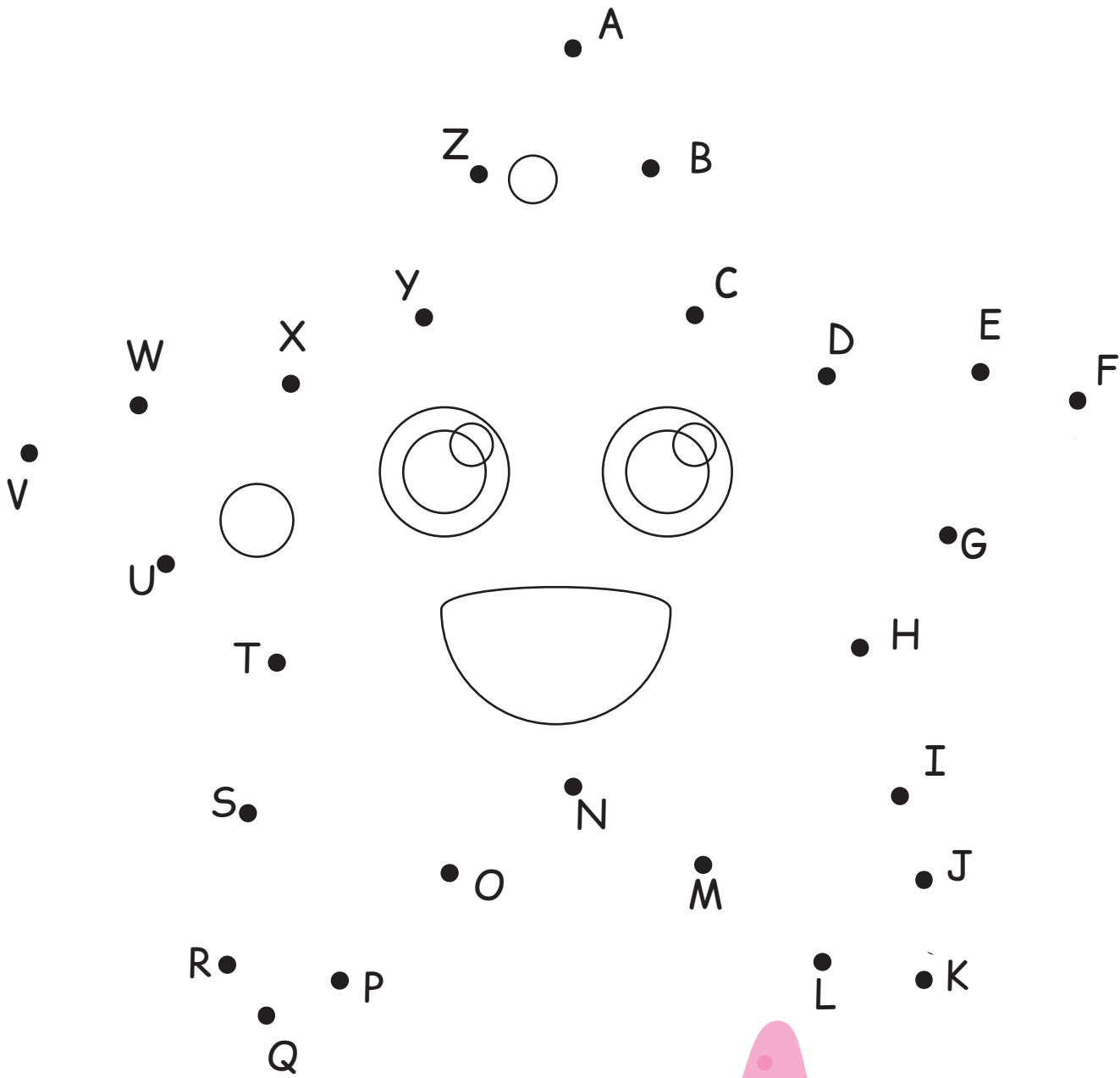

Dot to Dot

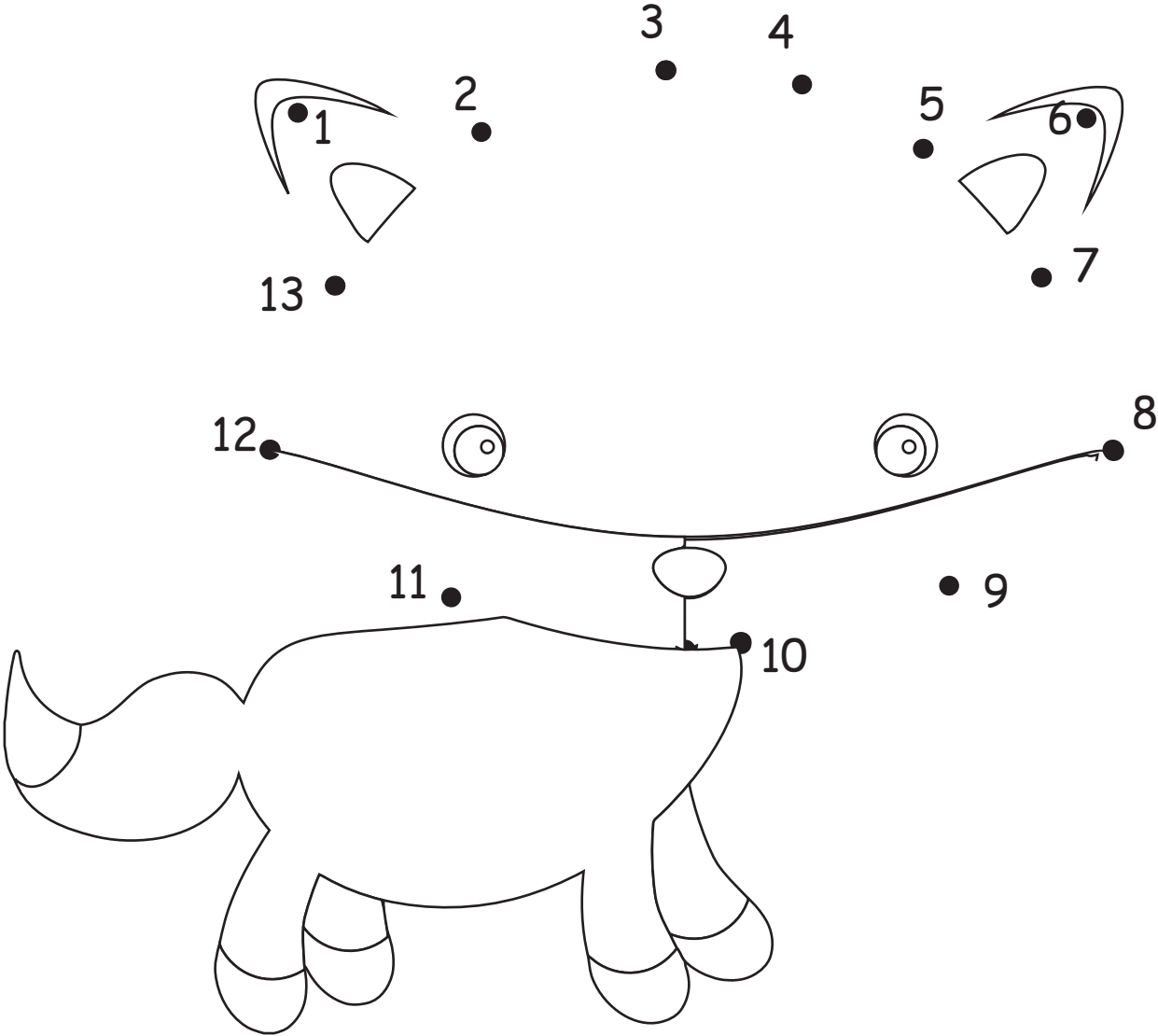

Dot to Dot

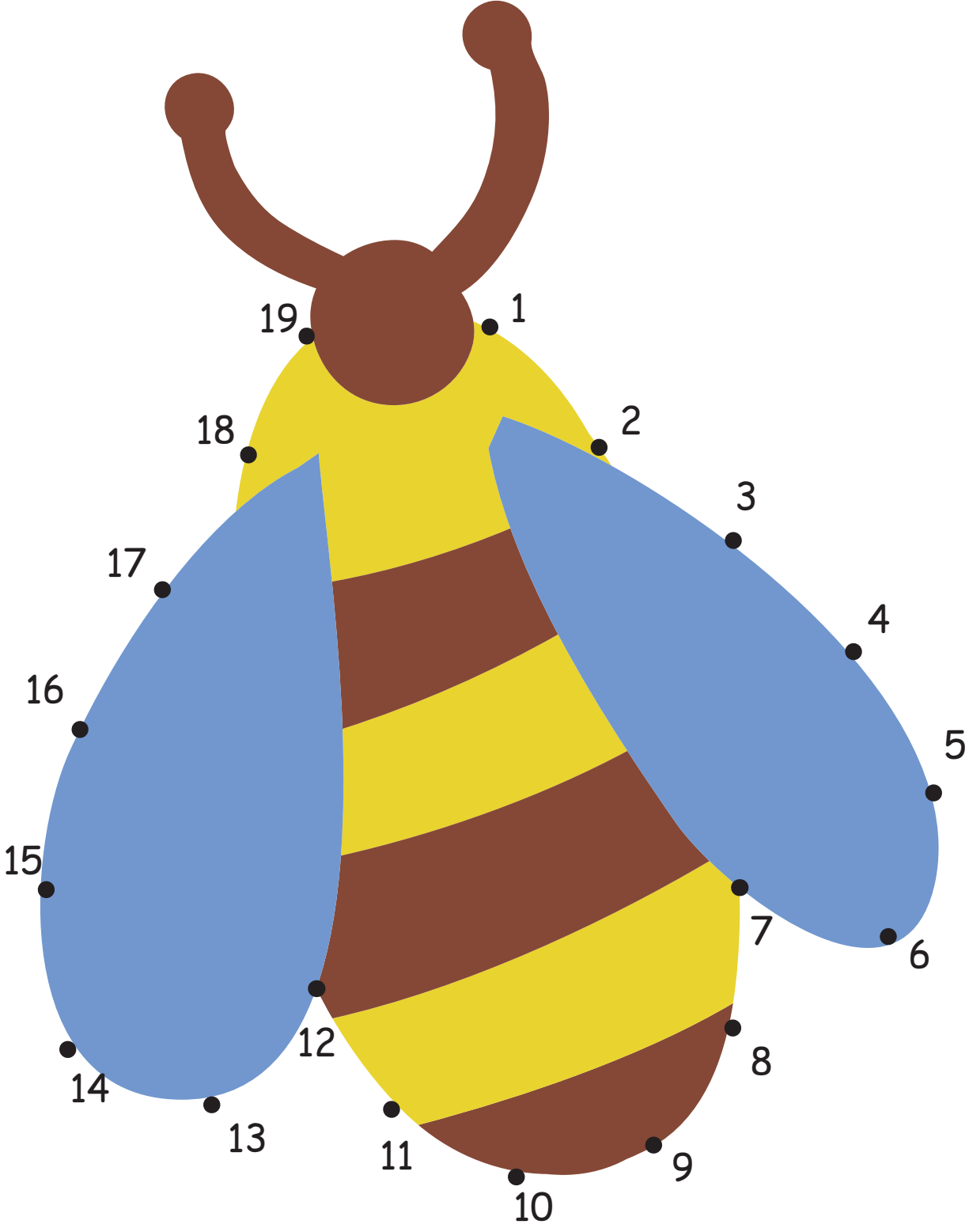

Dot to Dot

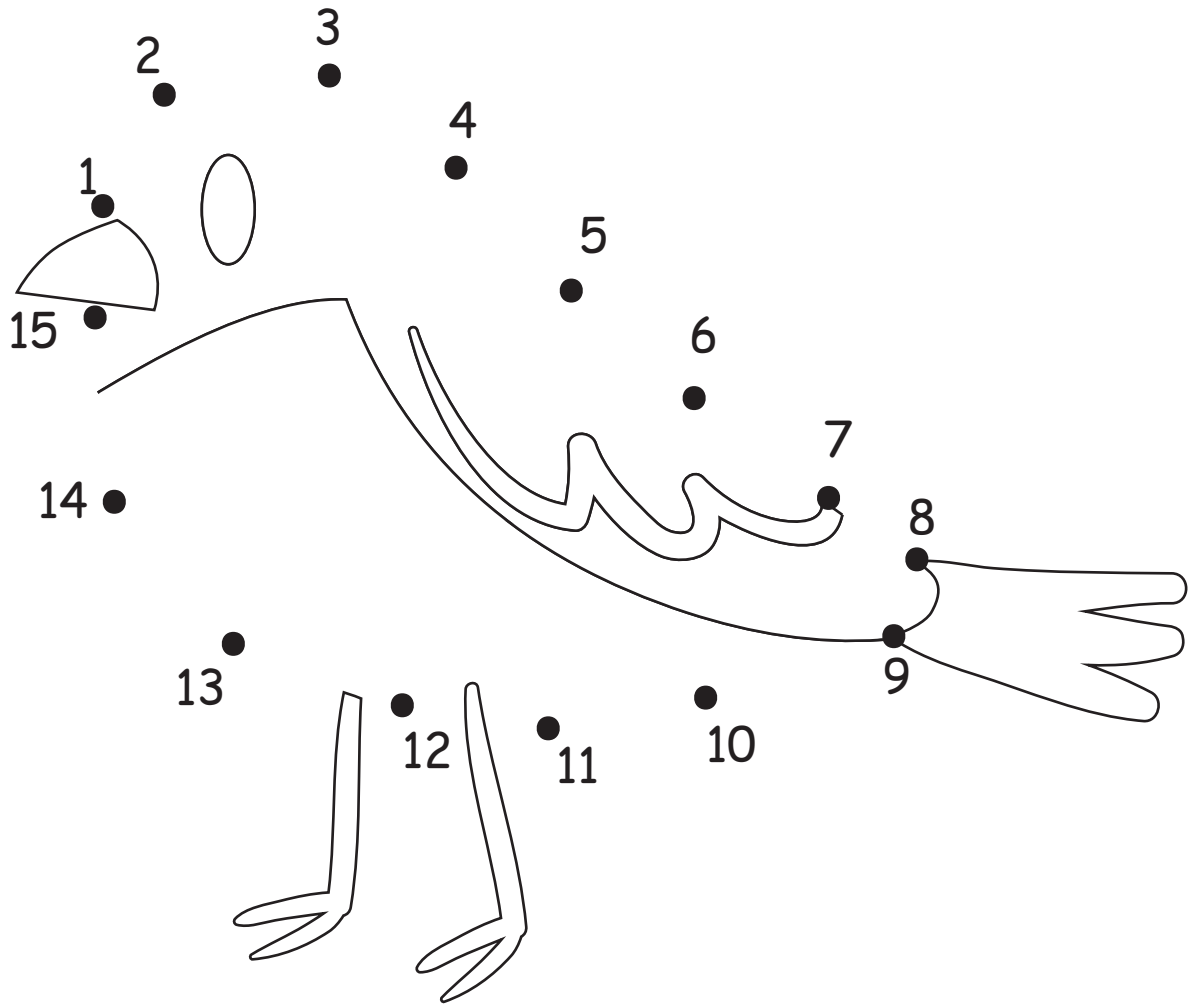

Dot to Dot

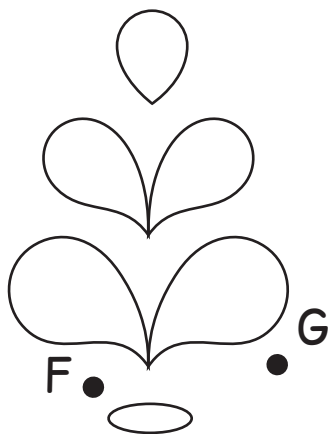

E.

I.

D.

O P Q R S
J N M U T

C.

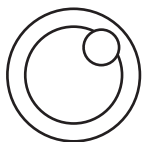

K L



B.

V W

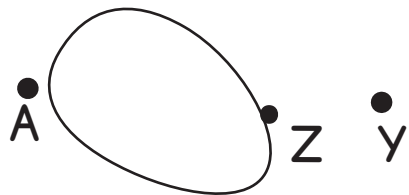

X.

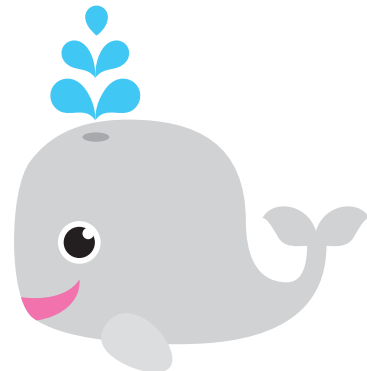

Dot to Dot

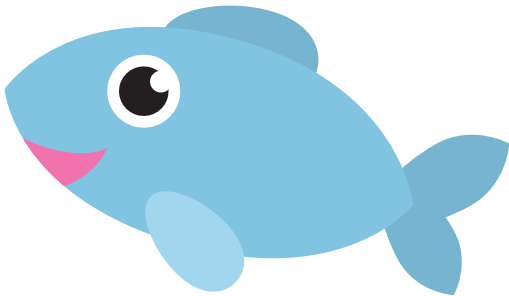
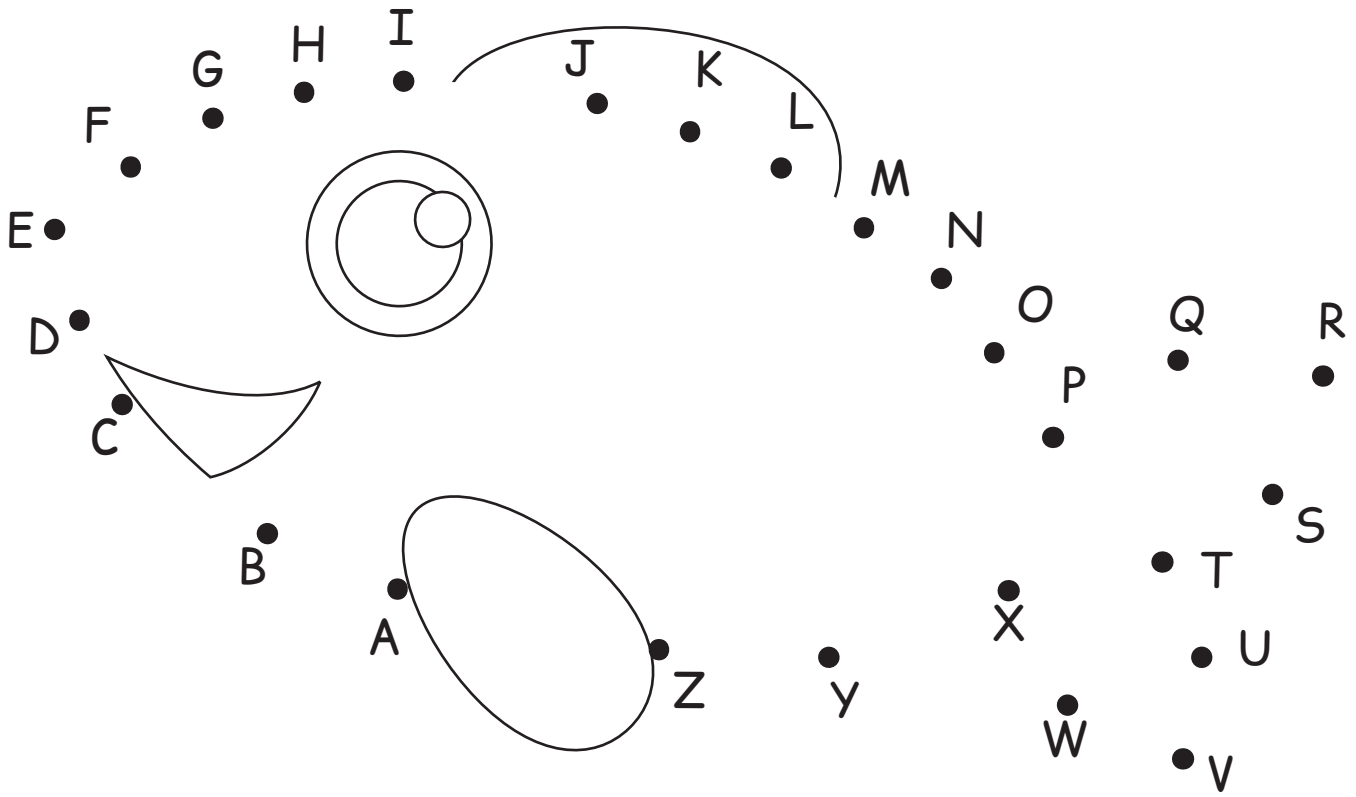

Dot to Dot

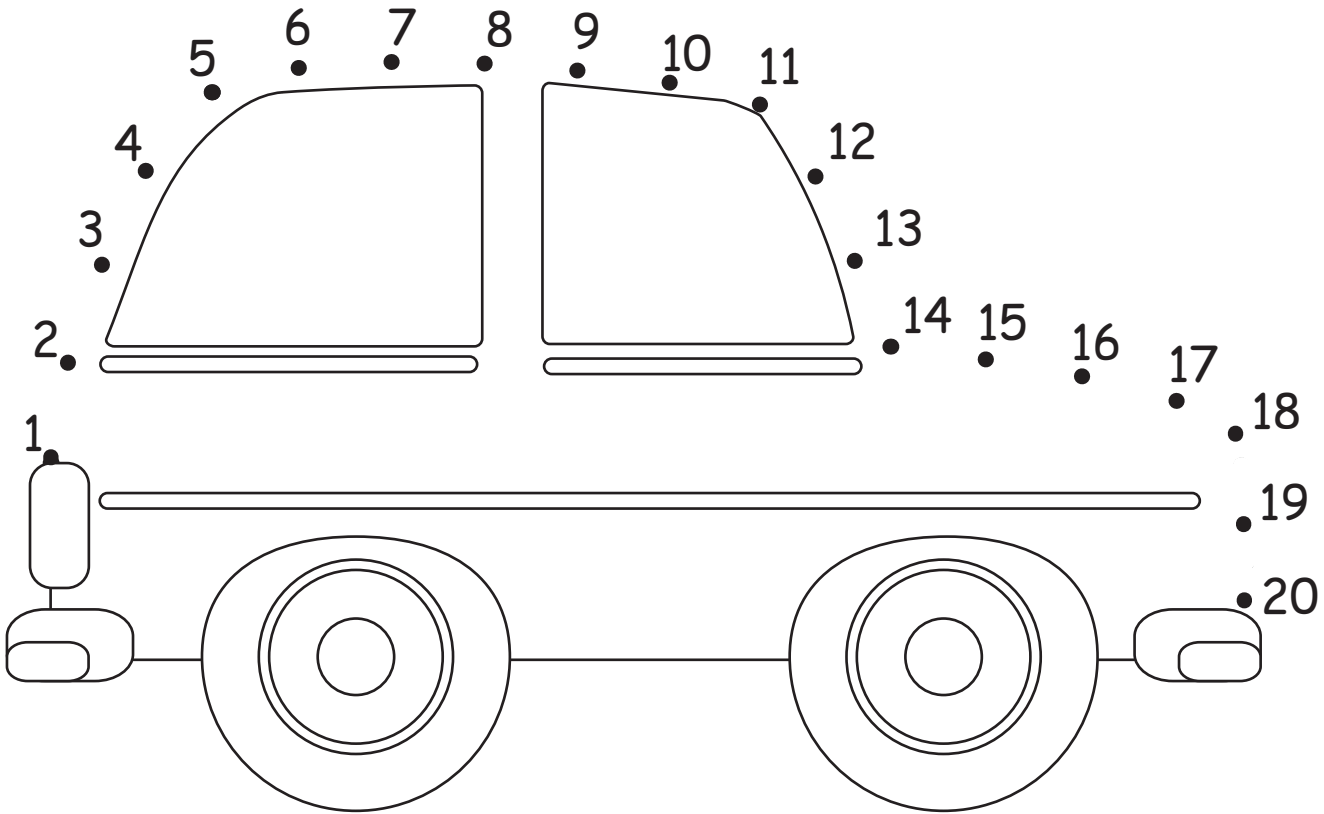

Dot to Dot

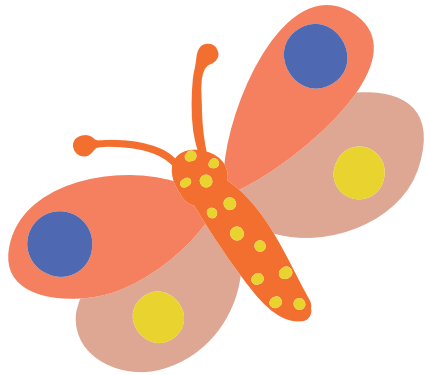
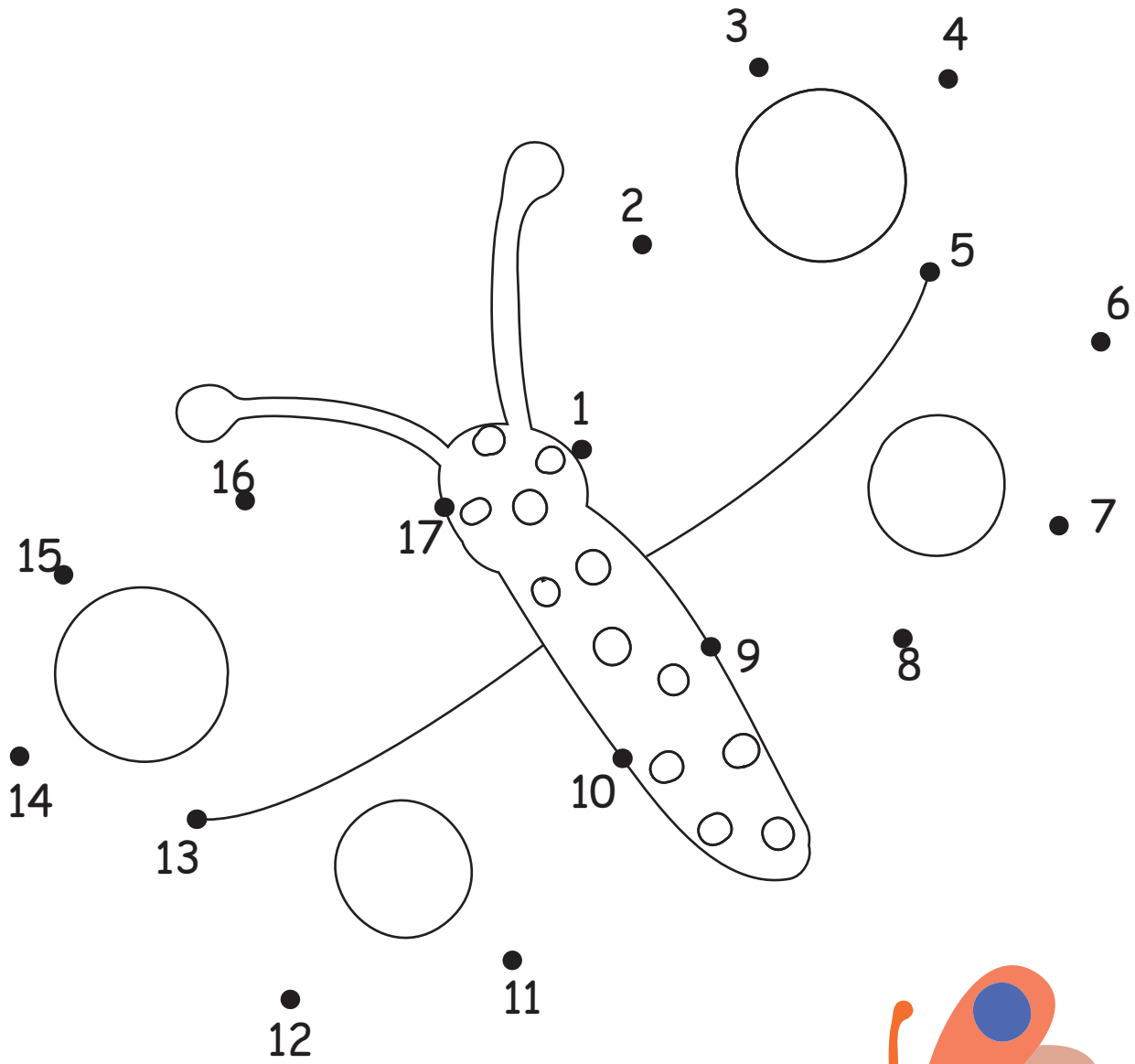

Dot to Dot

