



german english

die Torte
gateau

die Kirsche
cherry

der Teller
plate

die Gabel
fork



BILINGUAL DICTIONARY

VISUAL



Bilingual
VISUAL
dictionary

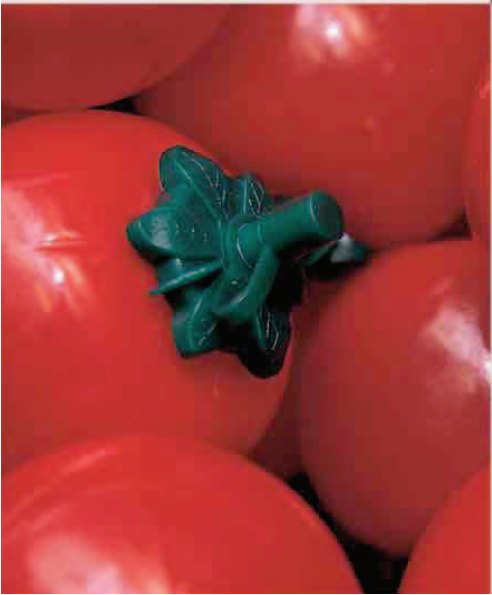
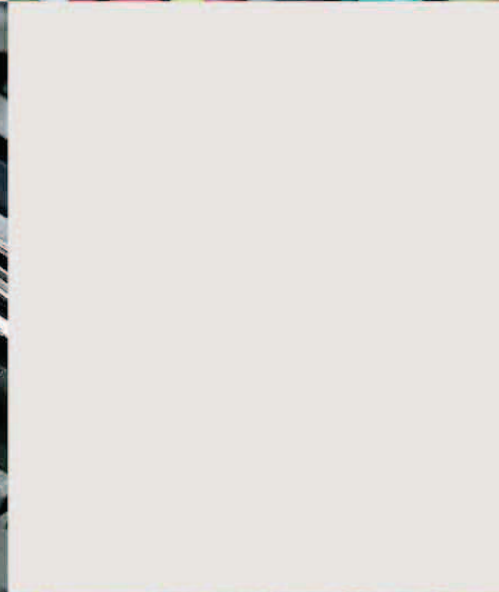

Bilingual **VISUAL** dictionary

Previously published as part of
5-Language Visual Dictionary





Penguin
Random
House

Senior Editor Angeles Gavira

Senior Art Editor Ina Stradins

DTP Designers Sunil Sharma, Balwant Singh,
Harish Aggarwal, John Goldsmid, Ashwani Tyagi

DTP Coordinator Pankaj Sharma

Production Controller Liz Cherry

Picture Researcher Anna Grapes

Managing Editor Liz Wheeler

Managing Art Editor Phil Ormerod

Category Publisher Jonathan Metcalf

Designed for Dorling Kindersley by WaltonCreative.com

Art Editor Colin Walton, assisted by Tracy Musson

Designers Peter Radcliffe, Earl Neish, Ann Cannings

Picture Research Marissa Keating

Language content for Dorling Kindersley by
g-and-w PUBLISHING

Managed by Jane Wightwick, assisted by Ana Bremón

Translation and editing by Christine Arthur

Additional input by Dr. Arturo Pretel, Martin Prill,

Frédéric Monteil, Meinrad Prill, Mari Bremón,

Oscar Bremón, Anunchi Bremón, Leila Gaafar

First American Edition, 2009

This edition published in the United States in 2015

by DK Publishing, 345 Hudson Street, New York,
New York 10014

Copyright © 2015 Dorling Kindersley Limited

A Penguin Random House Company

15 16 17 18 19 10 9 8 7 6 5 4 3 2 1

001 – BD221 – June/15

All rights reserved.

Without limiting the rights under the copyright reserved
above, no part of this publication may be reproduced,
stored in or introduced into a retrieval system, or transmitted,
in any form, or by any means (electronic, mechanical,
photocopying, recording, or otherwise), without the prior
written permission of the copyright owner.

Published in Great Britain by Dorling Kindersley Limited.

A catalog record for this book is available from the
Library of Congress.

ISBN: 978-1-4654-3631-3

DK books are available at special discounts when purchased
in bulk for sales promotions, premiums, fund-raising, or
educational use. For details, contact: DK Publishing Special
Markets, 345 Hudson Street, New York, New York 10014
SpecialSales@dk.com

Printed and bound in China

All images © Dorling Kindersley Limited

For further information see: www.dkimages.com

A WORLD OF IDEAS:
SEE ALL THERE IS TO KNOW

www.dk.com

Inhalt contents



die Gesundheit
health



auswärts essen
eating out



die Freizeit
leisure



8

**über das
Wörterbuch**
about the dictionary



9

**die Benutzung
des Buchs**
how to use this book



10

die Menschen
people



28

**die äußere
Erscheinung**
appearance



56

das Haus
home



92

die Dienstleistungen
services



102

der Einkauf
shopping



116

die Nahrungsmittel
food



160

das Lernen
study



170

die Arbeit
work



192

der Verkehr
transportation



218

der Sport
sports



278

die Umwelt
environment



302

die Information
reference



324

Register
index



360

Dank
acknowledgments

die Menschen •			die Kommunikation	98	
people			communications		
der Körper body	12	die Geburt childbirth	53	das Hotel hotel	100
das Gesicht face	14	die Alternativtherapien	54		
die Hand hand	15	alternative therapy		der Einkauf •	
der Fuß foot	15			shopping	
die Muskeln muscles	16	das Haus • home		das Einkaufszentrum	104
das Skelett skeleton	17	das Haus house	58	shopping center	
die inneren Organe	18	die Hausanschlüsse	60	das Kaufhaus	105
internal organs		internal systems		department store	
die Fortpflanzungsorgane	20	das Wohnzimmer living room	62	der Supermarkt	106
reproductive organs		das Esszimmer dining room	64	supermarket	
die Familie family	22	die Küche kitchen	66	die Apotheke pharmacy	108
die Beziehungen relationships	24	die Küchengeräte	68	das Blumengeschäft florist	110
die Gefühle emotions	25	kitchenware		der Zeitungshändler	112
die Ereignisse des Lebens	25	das Schlafzimmer bedroom	70	newsstand	
life events		das Badezimmer	72	der Konditor confectionery	113
		bathroom		andere Geschäfte	114
die äußere Erscheinung • appearance		das Kinderzimmer	74	other stores	
die Kinderkleidung	30	nursery		die Nahrungsmittel •	
children's clothing		der Allzweckraum utility room	76	food	
die Herrenkleidung	32	die Heimwerkstatt workshop	78	das Fleisch meat	118
men's clothing		der Werkzeugkasten	80	der Fisch fish	120
die Damenkleidung	34	toolbox		das Gemüse vegetables	122
women's clothing		das Tapezieren decorating	82	das Obst fruit	126
die Accessoires accessories	36	der Garten garden	84	die Getreidearten und	130
das Haar hair	38	die Gartenpflanzen	86	die Hülsenfrüchte	
die Schönheit beauty	40	garden plants		grains and legumes	
		die Gartengeräte garden tools	88	die Kräuter und Gewürze	132
die Gesundheit •		die Gartenarbeit gardening	90	herbs and spices	
health		die Dienstleistungen •		die Nahrungsmittel in	134
die Krankheit illness	44	services		Flaschen bottled foods	
der Arzt doctor	45	die Notdienste	94	die Milchprodukte	136
die Verletzung injury	46	emergency services		dairy produce	
die erste Hilfe first aid	47	die Bank bank	96	das Brot und das Mehl	138
das Krankenhaus hospital	48			breads and flours	
der Zahnarzt dentist	50			Kuchen und Nachspeisen	140
der Augenoptiker optometrist	51			cakes and desserts	
die Schwangerschaft	52			die Feinkost delicatessen	142
pregnancy				die Getränke drinks	144



auswärts essen •			
eating out			
das Café café	148		
die Bar bar	150		
das Restaurant restaurant	152		
der Schnellimbiss	154		
fast food			
das Frühstück breakfast	156		
die Hauptmahlzeit	158		
dinner			
das Lernen • study			
die Schule school	162		
die Mathematik maths	164		
die Wissenschaft science	166		
die Hochschule college	168		
die Arbeit • work			
das Büro office	172		
der Computer computer	176		
die Medien media	178		
das Recht law	180		
der Bauernhof farm	182		
der Bau construction	186		
die Berufe professions	188		
der Verkehr •			
transport			
die Straßen roads	194		
der Bus bus	196		
das Auto car	198		
das Motorrad motorcycle	204		
das Fahrrad bicycle	206		
der Zug train	208		
das Flugzeug aircraft	210		
der Flughafen airport	212		
das Schiff ship	214		
der Hafen port	216		
der Sport • sport			
der Football	220		
		football	
		das Rugby rugby	221
		der Fußball soccer	222
		das Hockey hockey	224
		das Cricket cricket	225
		der Basketball basketball	226
		der Baseball baseball	228
		das Tennis tennis	230
		das Golf golf	232
		die Leichtathletik track	234
		der Kampfsport	236
		combat sports	
		der Schwimmsport swimming	238
		der Segelsport sailing	240
		der Reitsport horse riding	242
		der Angelsport fishing	244
		der Skisport skiing	246
		die anderen Sportarten	248
		other sports	
		die Fitness fitness	250
		die Freizeit • leisure	
		das Theater theater	254
		das Orchester orchestra	256
		das Konzert concert	258
		die Besichtigungstour	260
		sightseeing	
		die Aktivitäten im Freien	262
		outdoor activities	
		der Strand beach	264
		das Camping camping	266
		die Privatunterhaltung	268
		home entertainment	
		die Fotografie photography	270
		die Spiele games	272
		das Kunsthandwerk	274
		arts and crafts	
		die Umwelt •	
		environment	
		der Weltraum space	280
		die Erde Earth	282
		die Landschaft landscape	284
		das Wetter weather	286
		das Gestein rocks	288
		die Mineralien minerals	289
		die Tiere animals	290
		die Pflanzen plants	296
		die Stadt town	298
		die Architektur	300
		architecture	
		die Information •	
		reference	
		die Uhrzeit time	304
		der Kalender calendar	306
		die Zahlen numbers	308
		die Maße und Gewichte	310
		weights and measures	
		die Weltkarte	312
		world map	
		Partikeln und Antonyme	320
		particles and antonyms	
		praktische Redewendungen	322
		useful phrases	

über das Wörterbuch

Bilder helfen erwiesenermaßen, Informationen zu verstehen und zu behalten. Dieses zweisprachige Wörterbuch enthält eine Fülle von Illustrationen und präsentiert gleichzeitig ein umfangreiches aktuelles Vokabular in zwei europäischen Sprachen.

Das Wörterbuch ist thematisch gegliedert und behandelt eingehend die meisten Bereiche des heutigen Alltags, vom Restaurant und Fitnesscenter, Heim und Arbeitsplatz bis zum Tierreich und Weltraum. Es enthält außerdem Wörter und Redewendungen, die für die Unterhaltung nützlich sind und das Vokabular erweitern.

Dies ist ein wichtiges Nachschlagewerk für jeden, der sich für Sprachen interessiert – es ist praktisch, anregend und leicht zu benutzen.

Einige Anmerkungen

Die zwei Sprachen werden immer in der gleichen Reihenfolge aufgeführt – Deutsch und Englisch.

Substantive werden mit den bestimmten Artikeln, die das Geschlecht (Maskulinum, Femininum oder Neutrum) und den Numerus (Singular oder Plural) ausdrücken, angegeben, zum Beispiel:

der Samen seed	die Mandeln almonds
--------------------------	-------------------------------

Die Verben sind durch ein (v) nach dem englischen Wort gekennzeichnet:

ernten • harvest (v)

Am Ende des Buchs befinden sich Register für jede Sprache. Sie können dort ein Wort in einer der zwei Sprachen und die jeweilige Seitenzahl nachsehen.

Die Geschlechtsangabe erfolgt mit folgenden Abkürzungen:

m = Maskulinum
f = Femininum
n = Neutrum

about the dictionary

The use of pictures is proven to aid understanding and the retention of information. Working on this principle, this highly illustrated bilingual dictionary presents a large range of useful current vocabulary in two European languages.

The dictionary is divided thematically and covers most aspects of the everyday world in detail, from the restaurant to the gym, the home to the workplace, outer space to the animal kingdom. You will also find additional words and phrases for conversational use and for extending your vocabulary.

This is an essential reference tool for anyone interested in languages – practical, stimulating, and easy to use.

A few things to note

The two languages are always presented in the same order—German and English.

In German, nouns are given with their definite articles reflecting the gender (masculine, feminine or neuter) and number (singular or plural), for example:

der Samen seed	die Mandeln almonds
--------------------------	-------------------------------

Verbs are indicated by a (v) after the English, for example:

ernten • harvest (v)

Each language also has its own index at the back of the book. Here you can look up a word in either of the two languages and be referred to the page number(s) where it appears. The gender is shown using the following abbreviations:

m = masculine
f = feminine
n = neuter



die Benutzung des Buchs

Ganz gleich, ob Sie eine Sprache aus Geschäftsgründen, zum Vergnügen oder als Vorbereitung für einen Auslandsurlaub lernen, oder Ihr Vokabular in einer Ihnen bereits vertrauten Sprache erweitern möchten, dieses Wörterbuch ist ein wertvolles Lernmittel, das Sie auf vielfältige Art und Weise benutzen können.

Wenn Sie eine neue Sprache lernen, achten Sie auf Wörter, die in verschiedenen Sprachen ähnlich sind sowie auf falsche Freunde (Wörter, die ähnlich aussehen aber wesentlich andere Bedeutungen haben). Sie können ebenfalls feststellen, wie die Sprachen einander beeinflusst haben. Englisch hat zum Beispiel viele Ausdrücke für Nahrungsmittel aus anderen europäischen Sprachen übernommen und andererseits viele Begriffe aus der Technik und Popkultur ausgeführt.

Praktische Übungen

- Versuchen Sie sich zu Hause, am Arbeits- oder Studienplatz den Inhalt der Seiten einzuprägen, die Ihre Umgebung behandeln. Schließen Sie dann das Buch und prüfen Sie, wie viele Gegenstände Sie in den anderen Sprachen sagen können.
- Schreiben Sie eine Geschichte, einen Brief oder Dialog und benutzen Sie dabei möglichst viele Ausdrücke von einer bestimmten Seite des Wörterbuchs. Dies ist eine gute Methode, sich das Vokabular und die Schreibweise einzuprägen. Sie können mit kurzen Sätzen von zwei bis drei Worten anfangen und dann nach und nach längere Texte schreiben.
- Wenn Sie ein visuelles Gedächtnis haben, können Sie Gegenstände aus dem Buch abzeichnen oder abpausen. Schließen Sie dann das Buch und schreiben Sie die passenden Wörter unter die Bilder.
- Wenn Sie mehr Sicherheit haben, können Sie Wörter aus einem der Fremdsprachenregister aussuchen und deren Bedeutung aufschreiben, bevor Sie auf der entsprechenden Seite nachsehen.

how to use this book

Whether you are learning a new language for business, pleasure, or in preparation for an overseas vacation, or are hoping to extend your vocabulary in an already familiar language, this dictionary is a valuable learning tool that you can use in a number of different ways.

When learning a new language, look for cognates (words that are alike in different languages) and “false friends” (words that look alike but carry significantly different meanings). You can also see where the languages have influenced each other. For example, English has imported many terms for food from other European languages but, in turn, exported terms used in technology and popular culture.

Practical learning activities

- As you move around your home, workplace, or school, try looking at the pages which cover that setting. You could then close the book, look around you, and see how many of the objects and features you can name.
- Challenge yourself to write a story, letter, or dialogue using as many of the terms on a particular page as possible. This will help you retain the vocabulary and remember the spelling. If you want to build up to writing a longer text, start with sentences incorporating 2–3 words.
- If you have a very visual memory, try drawing or tracing items from the book onto a piece of paper, then closing the book and filling in the words below the picture.
- Once you are more confident, pick out words in a foreign-language index and see if you know what they mean before turning to the relevant page to check if you were right.







die Menschen
people

der Körper • body

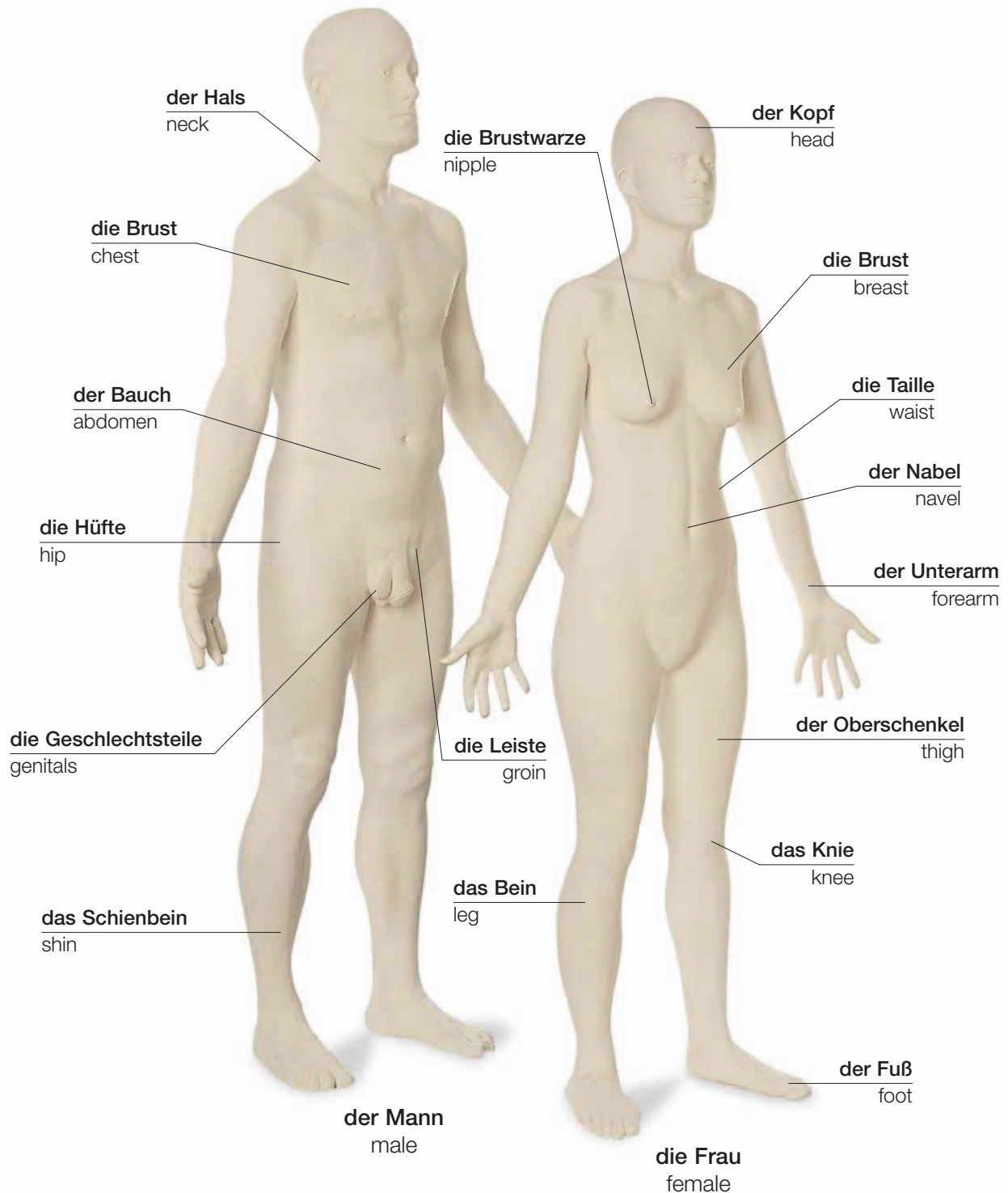

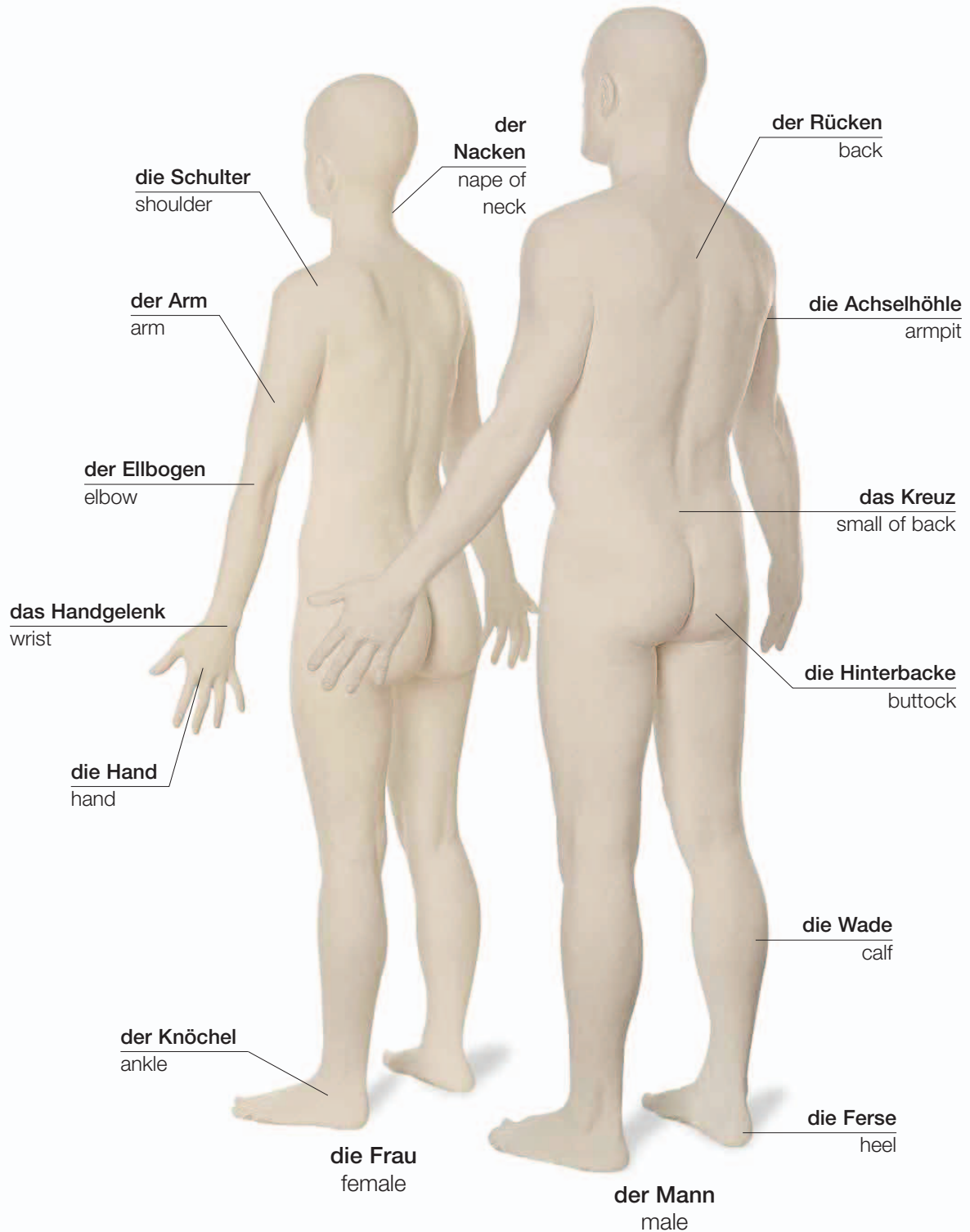

das Gesicht • face

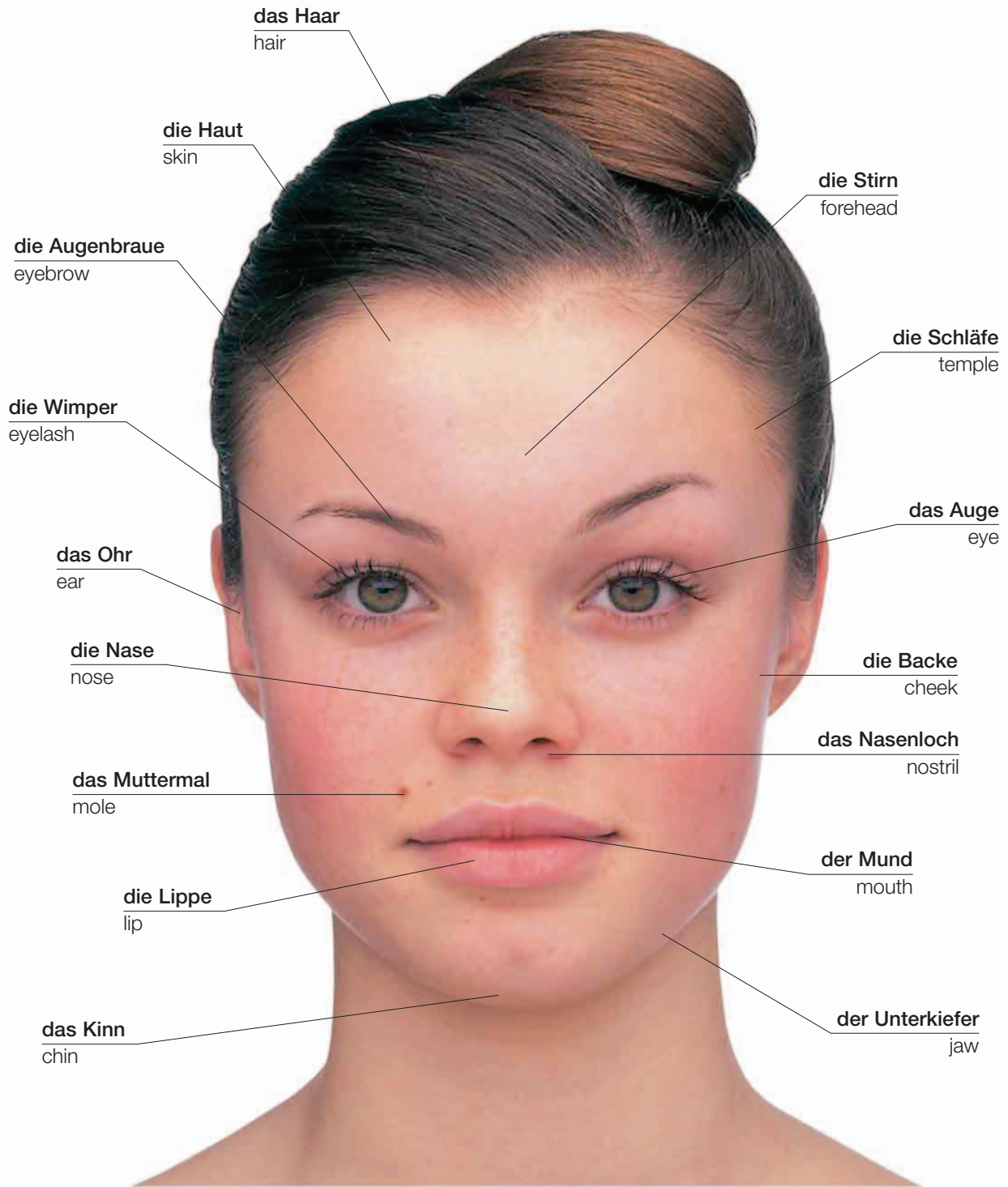



die Falte
wrinkle

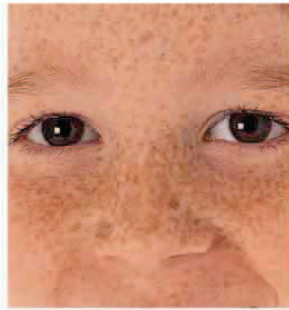

die Sommersprosse
freckle

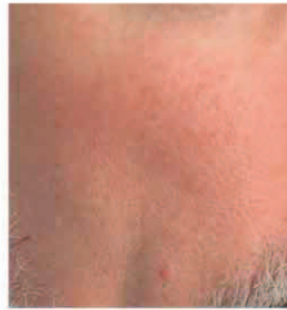

die Pore
pore

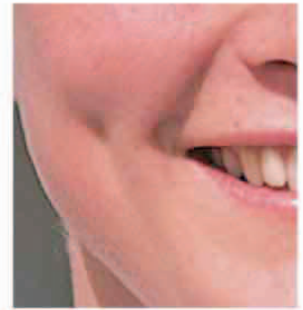

das Grübchen
dimple

die Hand • hand



der Fuß • foot



die Muskeln • muscles

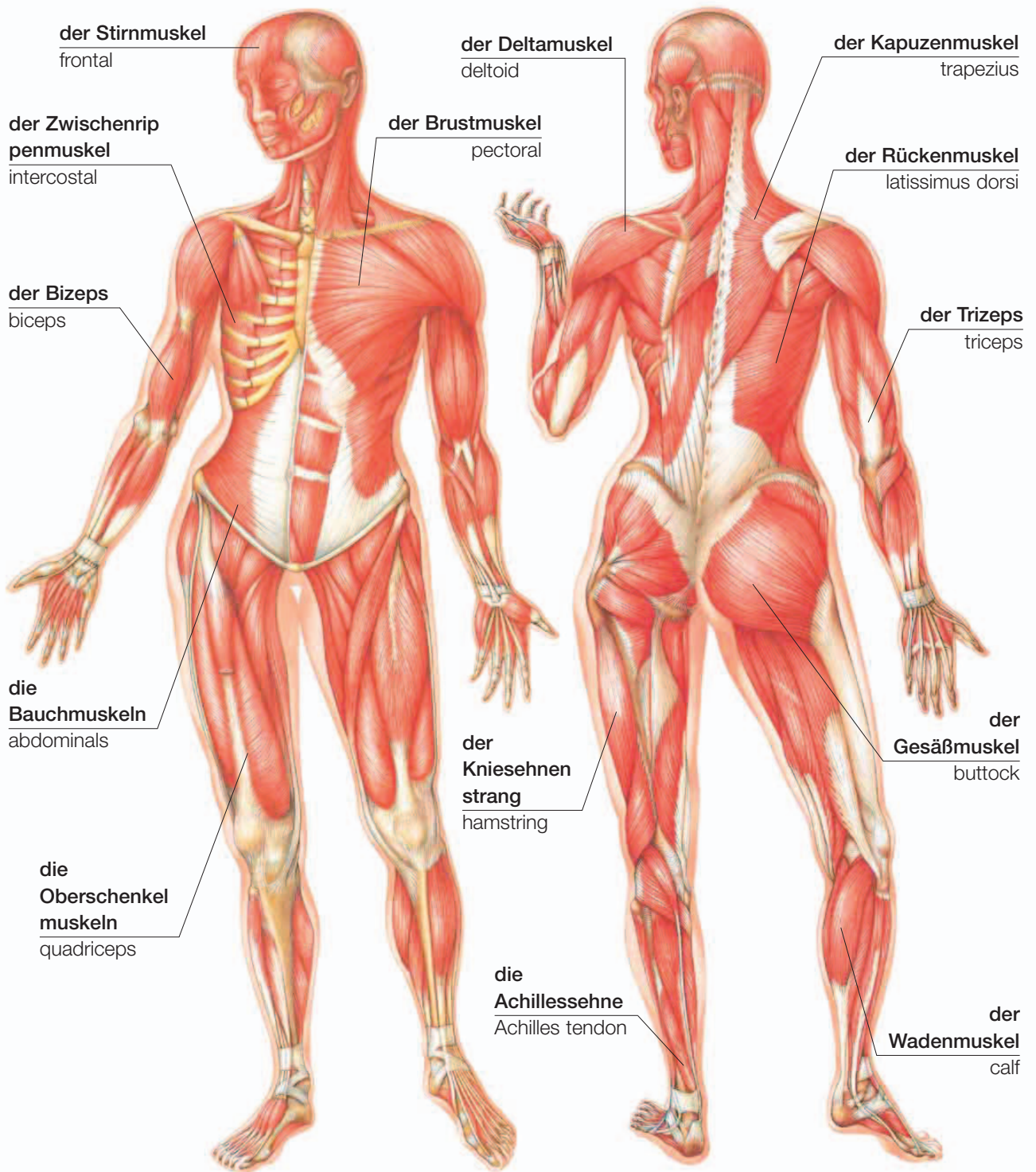

das Skelett • skeleton

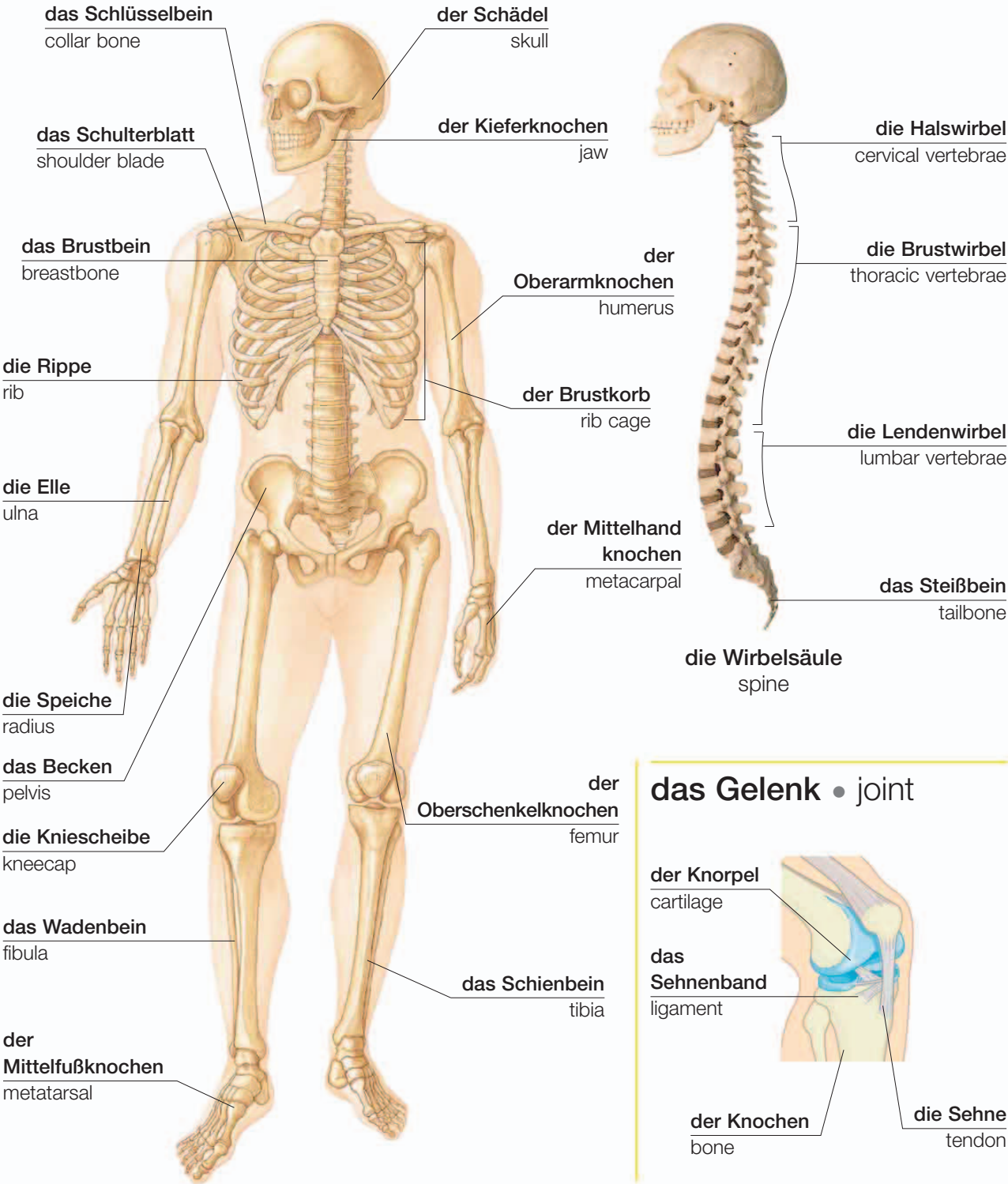

die inneren Organe • internal organs

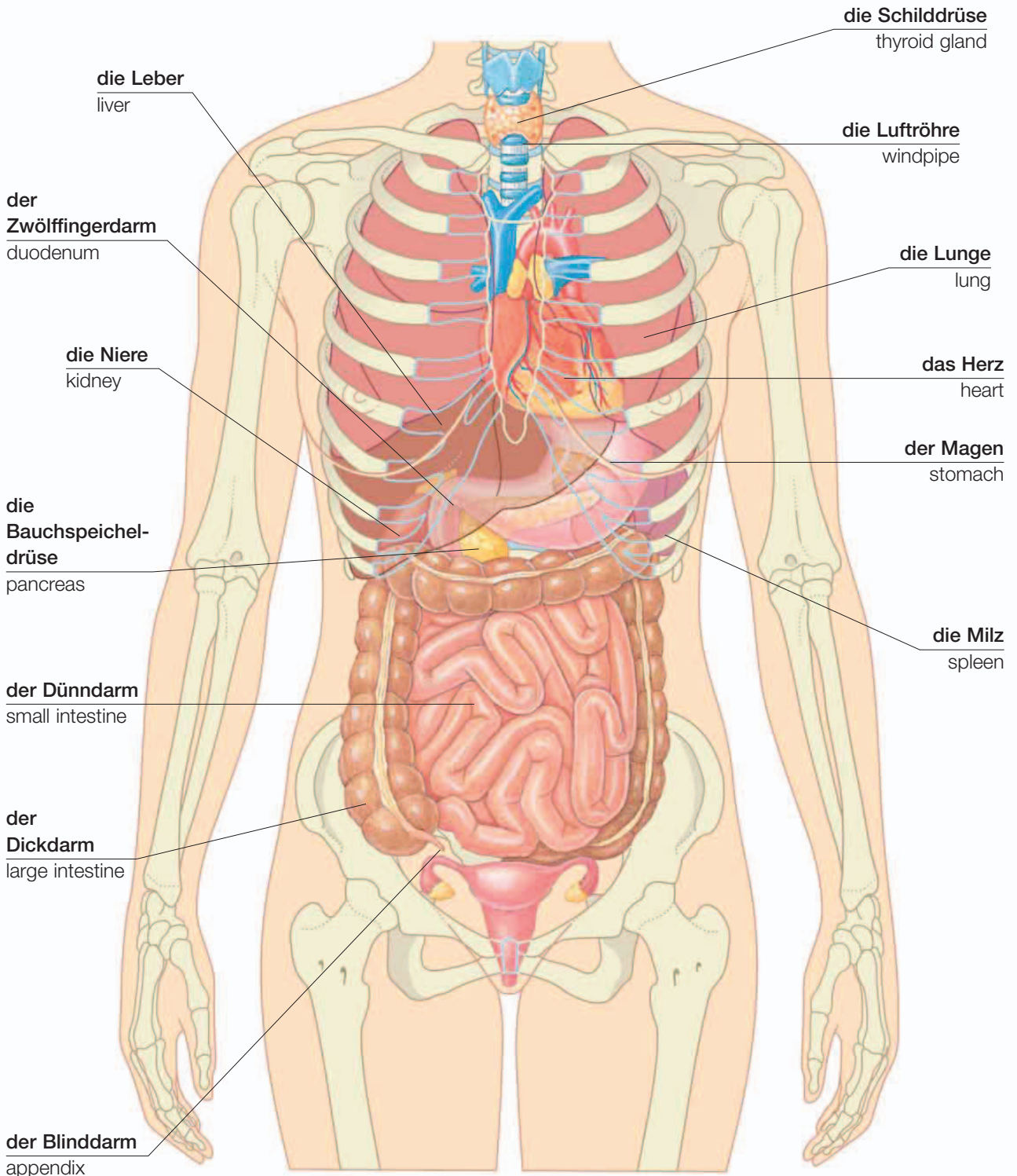

der Kopf • head

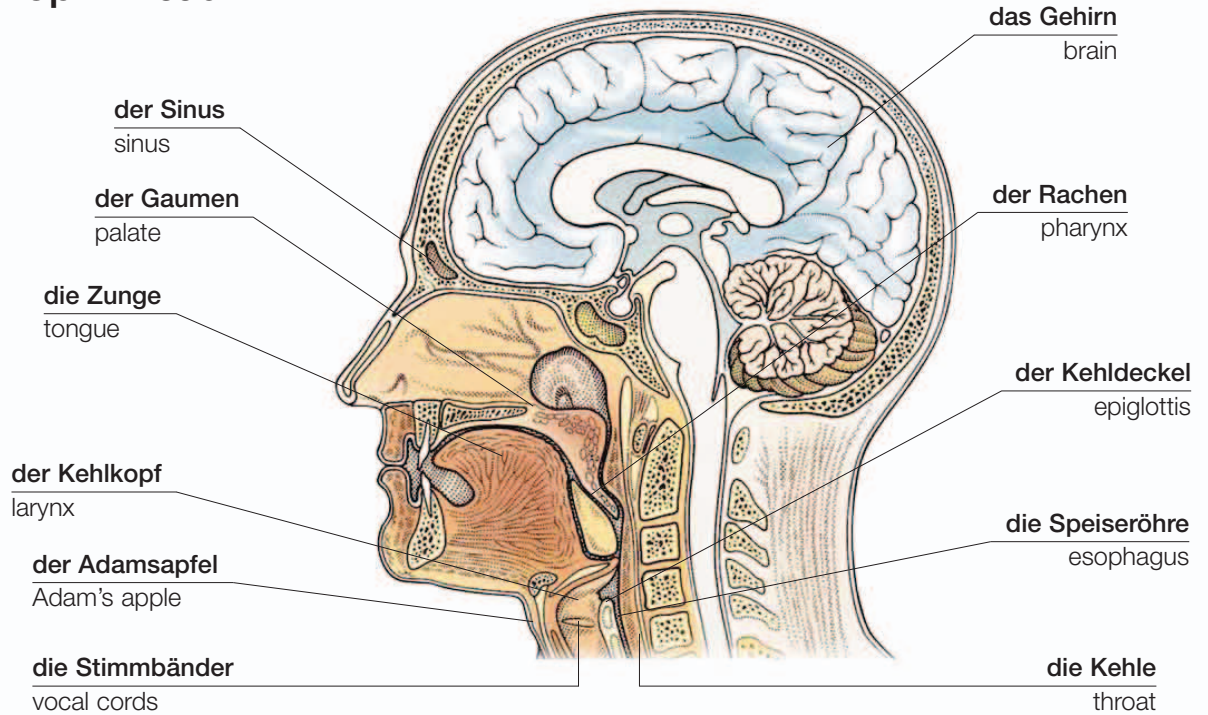

die Körpersysteme • body systems

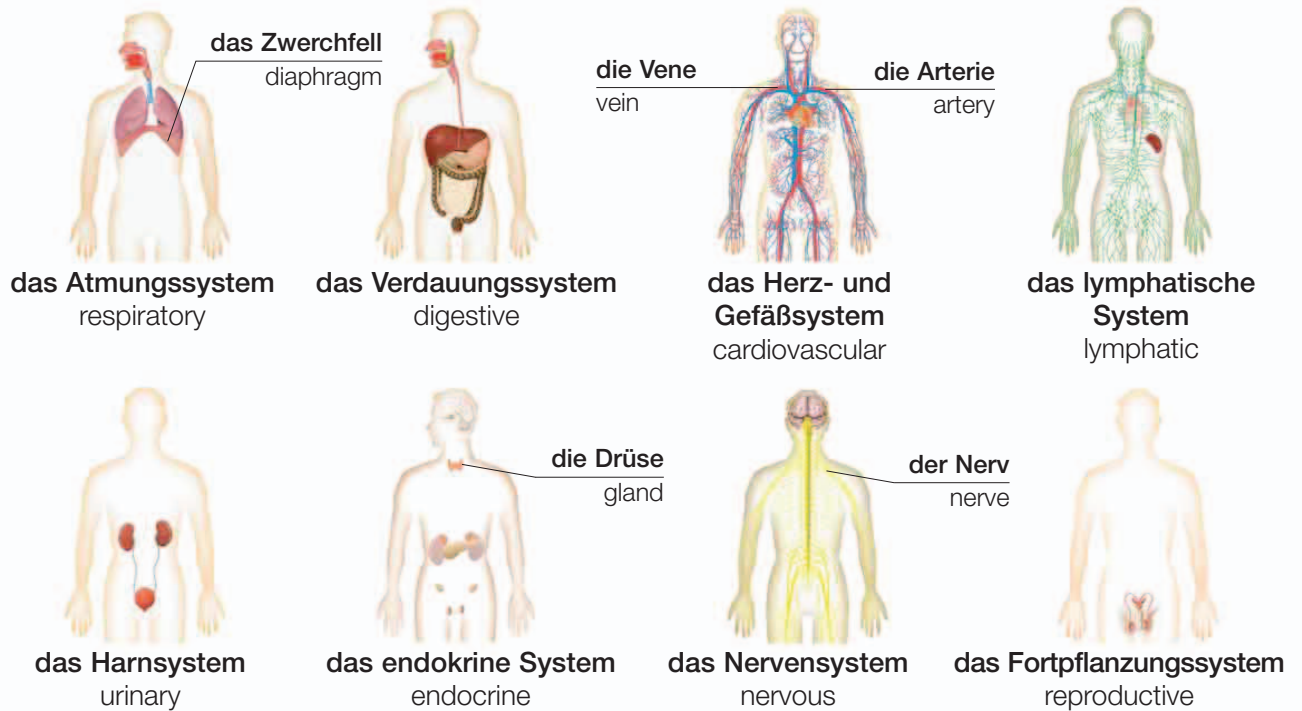

die Fortpflanzungsorgane • reproductive organs

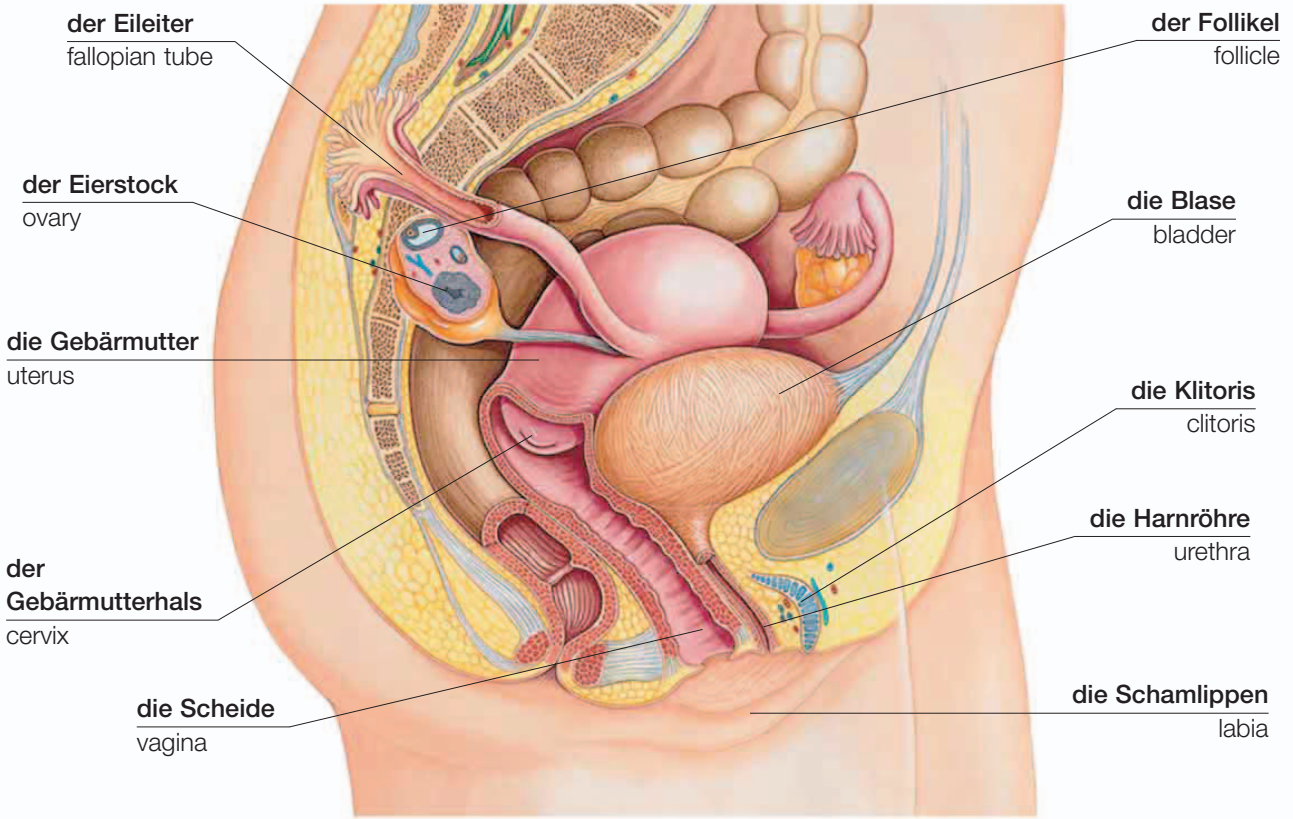

weiblich | female

die Fortpflanzung • reproduction

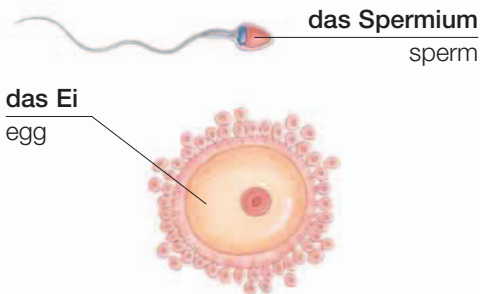

die Befruchtung | fertilization

Vokabular • vocabulary

steril
infertile

impotent
impotent

die Menstruation
menstruation

fruchtbar
fertile

empfangen
conceive

der Geschlechtsverkehr
intercourse

das Hormon
hormone

der Eisprung
ovulation

die Geschlechtskrankheit
sexually transmitted disease

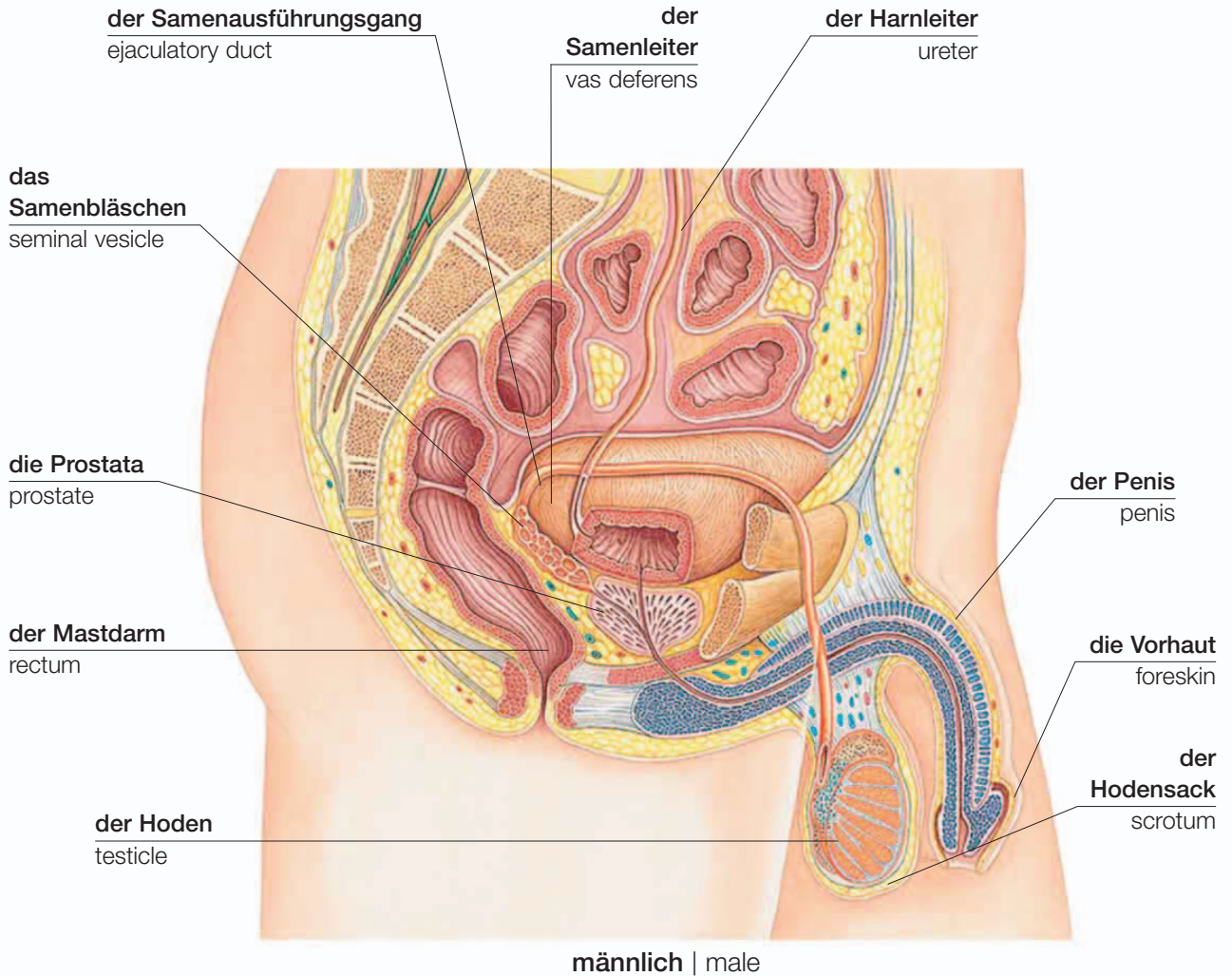

die Empfängnisverhütung • contraception



die Familie • family



Vokabular • vocabulary

die Großeltern grandparents	die Verwandten relatives	die Enkelkinder grandchildren	die Stiefmutter stepmother	die Stieftochter stepdaughter	die Generation generation
die Eltern parents	die Kinder children	der Stiefvater stepfather	der Stiefsohn stepson	der Partner/die Partnerin partner	die Zwillinge twins



die Schwiegermutter
mother-in-law



der Schwiegervater
father-in-law



der Schwager
brother-in-law



die Schwägerin
sister-in-law



die Nichte
niece



der Neffe
nephew

Fräulein
Miss

die Anreden • titles

Frau
Mrs.

Herr
Mr.



die Stadien • stages



das Baby
baby



das Kind
child



der Junge
boy



das Mädchen
girl



die Jugendliche
teenager



der Erwachsene
adult



der Mann
man



die Frau
woman

die Beziehungen • relationships

die
Assistentin
assistant

der **Chef**
manager



die
Geschäftspartnerin
business partner

der
Arbeitnehmer
employee

die
Arbeitgeberin
employer

der
Kollege
colleague



das Büro | office



der Nachbar
neighbor



der Freund
friend



der Bekannte
acquaintance



der Brieffreund
pen pal

der Freund
boyfriend



das Paar | couple

die Freundin
girlfriend

der Verlobte
fiancé



die Verlobte
fiancée

die Verlobten | engaged couple

die Ereignisse des Lebens • life events



geboren werden
be born (v)



zur Schule kommen
start school (v)



sich befreunden
make friends (v)



graduieren
graduate (v)



eine Stelle bekommen
get a job (v)



sich verlieben
fall in love (v)



heiraten
get married (v)



ein Baby bekommen
have a baby (v)



die Hochzeit | wedding



die Scheidung
divorce



das Begräbnis
funeral

vokabular • vocabulary

die Taufe
christening

emigrieren
emigrate (v)

die Bar Mizwa
bar mitzvah

sterben
die (v)

der Hochzeitstag
anniversary

die Hochzeitsfeier
wedding reception

in den Ruhestand treten
retire (v)

die Hochzeitsreise
honeymoon

sein Testament machen
make a will (v)

die Geburtsurkunde
birth certificate

die Feste • celebrations

die
Geburtstagsfeier
birthday party



der Geburtstag
birthday

die Karte
card



das Geschenk
present



das Weihnachten
Christmas

die Feste •
festivals



das Passah
Passover



das Neujahr
New Year



der Karneval
carnival

der Umzug
procession



der Ramadan
Ramadan

das Band
ribbon



der Thanksgiving Day
Thanksgiving



das Ostern
Easter



das Halloween
Halloween



das Diwali
Diwali





die äußere Erscheinung
appearance

die Kinderkleidung • children's clothing

das Baby • baby



das
Hemdchen
undershirt

der
Strampelanzug
coverall

der
Druckknopf
snap



der **Schlafanzug**
sleeper



der **Schneeanzug**
snowsuit



der **Spielanzug**
romper



das **Lätzchen**
bib



die
Babyhandschuhe
mittens



die
Babyschuhe
booties



die
Stoffwindel
cloth diaper



die
Wegwerfwindel
disposable diaper



das
Gummihöschen
plastic pants

das Kleinkind • toddler



der **Sonnenhut**
sun hat



die **Schürze**
apron



die **Latzhose**
overalls

die **Shorts**
shorts



das **T-Shirt**
T-shirt

der **Rock**
skirt

das Kind • child



das Kleid
dress

die Kapuze
hood

die Sandalen
sandals

der Sommer
summer



die Jeans
jeans

der Regenmantel
raincoat



der Rucksack
backpack

der Knebelknopf
toggle

der Herbst
fall



der Dufflecoat
duffle coat



der Schal
scarf

der Anorak
parka

die Gummistiefel
wellington boots

der Winter
winter



der Morgenrock
bathrobe

das Logo
logo

die Sportschuhe
athletic shoes

das Nachthemd
nightgown

die Hausschuhe
slippers

die Nachtwäsche
nightwear



der Fußballdress
soccer uniform



der Trainingsanzug
jogging suit



die Leggings
leggings

Vokabular • vocabulary

die Naturfaser
natural fiber

synthetisch
synthetic

Ist es waschmaschinenfest?
Is it machine washable?

Passt das einem
Zweijährigen?
Will this fit a two-year-old?

die Herrenkleidung • men's clothing



Vokabular • vocabulary

die Strickjacke
cardigan

die Unterwäsche
underwear

der Trainingsanzug
jogging suit

der Bademantel
dressing gown

der Mantel
coat

lang
long

kurz
short

Haben Sie das eine Nummer größer/kleiner?
Do you have this in a larger/smaller size?

Kann ich das anprobieren?
May I try this on?



der Blazer
blazer



das Sportjackett
sport coat



die Weste
waistcoat

der V-Ausschnitt
V-neck

der runde Ausschnitt
round neck



das T-Shirt
T-shirt



der Anorak
parka



das Sweatshirt
sweatshirt



das Hemd
shirt

die Jeans
jeans



der Pullover
sweater



der Schlafanzug
pajamas



das Unterhemd
vest

die Freizeitkleidung
casual wear



die Shorts
shorts



der Slip
briefs



die Boxershorts
boxer shorts



die Socken
socks

die Damenkleidung • women's clothing



die Unterwäsche • lingerie



der Morgenmantel
robe



der Unterrock
slip

der Träger
strap



das Mieder
camisole



das Bustier
bustier

der Strumpfhalter
garter



der Strumpf
stocking



die Strumpfhose
pantyhose



der Büstenhalter
bra



der Slip
panties



das Nachthemd
nightgown

die Hochzeit • wedding



die Spitze
lace

der Schleier
veil

das Bukett
bouquet

die Schleppe
train

das Hochzeitskleid
wedding dress

Vokabular • vocabulary

das Korsett
corset

gut geschnitten
tailored

rückenfrei
halter neck

das Strumpfband
garter

der Rockbund
waistband

der Sport-BH
sports bra

das Schulterpolster
shoulder pad

mit Formbügeln
underwired

die Accessoires • accessories



die Mütze
cap



der Hut
hat



das Halstuch
scarf



der Gürtel
belt

die Gürtelschnalle
buckle



der Griff
handle

die Spitze
tip



das Taschentuch
handkerchief



die Fliege
bow tie



die Krawattennadel
tie-pin



die Handschuhe
gloves

der Regenschirm
umbrella

der Schmuck • jewelry



der Anhänger
pendant



die Brosche
brooch



der Manschettenknopf
cufflink

das Glied
link

der Verschluss
clasp



das Armband
bracelet



die Kette
chain

der Edelstein
stone

die Halskette
necklace

der Ohrring
earring

der Ring
ring

die Uhr
watch

die Perlenkette
string of pearls



der Schmuckkasten | jewelry box

die Taschen • bags



die Brieftasche
wallet



das
Portemonnaie
purse



die
Umhängetasche
shoulder bag

der Verschluss
fastening

der
Schulterriemen
shoulder strap

die Griffe
handles



die Reisetasche
duffle bag



die Aktentasche
briefcase



die Handtasche
handbag



der Rucksack
backpack

die Schuhe • shoes

der Schnürsenkel
lace

die Zunge
tongue

die Öse
eyelet

die Sohle
sole



der Schnürschuh
lace-up

der Absatz
heel



der Stiefel
boot



der Wanderschuh
walking boot



der Sportschuh
athletic shoe



die
Strandsandale
flip-flop



der
Herrenhalbschuh
brogue



der Schuh mit
hohem Absatz
high-heeled shoe



der Keilschuh
wedge



die Sandale
sandal



der Slipper
slip-on



der Pumps
pump

das Haar • hair

der Kamm
comb



kämmen
comb (v)

die
Haarbürste
brush



bürsten | brush (v)



ausspülen
rinse (v)



die Friseurin
hairdresser

das
Washbecken
sink

die Kundin
client

waschen | wash (v)



der
Frisierumhang
robe

schneiden
cut (v)



föhnen
blow-dry (v)



legen
set (v)

die Frisierartikel • accessories



der Föhn
hairdryer



das Shampoo
shampoo



die Haarspülung
conditioner



das Haargel
gel



das Haarspray
hairspray



die Schere
scissors



der Haarreif
headband



der Haarglätter
hair straighteners



die Haarklammer
hairpin

die Frisuren • styles



der Pferdeschwanz
ponytail



der Zopf
braid



die Hochfrisur
French braid



der Haarknoten
bun



die Schwänzchen
pigtails



der Bubikopf
bob



der Kurzhaarschnitt
crop



kraus
curly



die Dauerwelle
perm



glatt
straight

die Wurzeln
roots



die Strähnen
highlights



kahl
bald



die Perücke
wig

die Haarfarben • colors



blond
blonde



brünett
brunette



rotbraun
auburn



rot
red



schwarz
black



grau
grey



weiß
white



gefärbt
dyed

Vokabular • vocabulary

das Haarband
hairband

fettig
greasy

nachschneiden
trim (v)

trocken
dry

der Herrenfriseur
barber

normal
normal

die Schuppen
dandruff

die Kopfhaut
scalp

der Haarspliss
split ends

glätten
straighten (v)

die Schönheit • beauty



das Haarfärbemittel
hair dye

der Lidschatten
eyeshadow

die
Wimperntusche
mascara

der Eyeliner
eyeliner

das Puderrouge
blusher

die Grundierung
foundation

der Lippenstift
lipstick

das Make-up • makeup



der Augenbrauenstift
eyebrow pencil



das Brauenbürstchen
eyebrow brush



die Pinzette
tweezers



das Lipgloss
lip gloss



der Lippenpinsel
lip brush



der Lippenkonturenstift
lip liner



der Puderpinsel
brush



der Korrekturstift
concealer

der Spiegel
mirror

der Gesichtspuder
face powder

die Puderquaste
powder puff



die Puderdose | compact

die Schönheitsbehandlungen • beauty treatments



die Maniküre • manicure

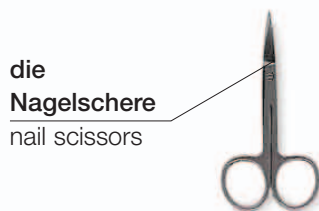

die Toilettenartikel • toiletries



Vokabular • vocabulary

die Sonnenbräune tan	empfindlich sensitive	hell fair
die Tätowierung tattoo	der Farbton shade	dunkel dark
die Wattebällchen cotton balls	Antifalten- antiwrinkle	trocken dry
hypoallergen hypoallergenic	der Teint complexion	fettig oily





die Gesundheit
health



die Krankheit • illness



das Fieber | fever



die Kopfschmerzen
headache



das Nasenbluten
nosebleed



der Husten
cough



das Niesen
sneeze



die Erkältung
cold



die Grippe
flu



der Inhalationsapparat
inhaler



die Krämpfe
cramps



die Übelkeit
nausea



die Windpocken
chickenpox



der Hautausschlag
rash

das Asthma
asthma

Vokabular • vocabulary

der Herzinfarkt
heart attack

die Allergie
allergy

das Ekzem
eczema

die Verkühlung
chill

die Epilepsie
epilepsy

der Durchfall
diarrhea

der Blutdruck
blood pressure

der Mumps
mumps

der Virus
virus

die Migräne
migraine

sich übergeben
vomit (v)

die Masern
measles

der Schlaganfall
stroke

die Zuckerkrankheit
diabetes

die Infektion
infection

die Magenschmerzen
stomachache

in Ohnmacht fallen
faint (v)

der Heuschnupfen
hayfever

der Arzt • doctor
die Konsultation • consultation

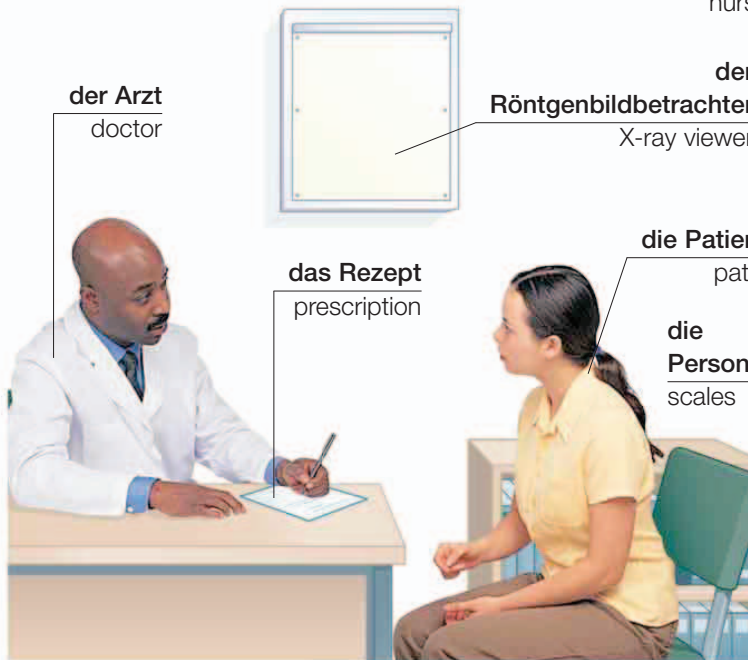

der Arzt
doctor

das Rezept
prescription

der Röntgenbildbetrachter
X-ray viewer

die Patientin
patient

die Personenwaage
scales



**die Kranken-
schwester**
nurse

die Luftmanschette
cuff

**das elektrische
Blutdruckmessgerät**
electric blood pressure
monitor



Vokabular • vocabulary

der Termin
appointment

die Impfung
vaccination

das Sprechzimmer
surgery

die Untersuchung
medical
examination

der Warteraum
waiting room

das Thermometer
thermometer

**Ich muss mit einem Arzt
sprechen.**

I need to see a doctor.

Es tut hier weh.

It hurts here.

die Verletzung • injury



die Verstauchung | sprain

die Schlinge
sling



die Fraktur
fracture

die Halskrawatte
neck brace



das Schleudertrauma
whiplash



der Schnitt
cut



die Abschürfung
graze



die Prellung
bruise



der Splitter
splinter



der Sonnenbrand
sunburn



die Brandwunde
burn



der Biss
bite



der Stich
sting

Vokabular • vocabulary

der Unfall
accident

die Blutung
hemorrhage

die Kopfverletzung
head injury

Wird er/sie es gut überstehen?
Will he/she be all right?

der Notfall
emergency

die Blase
blister

die Vergiftung
poisoning

Rufen Sie bitte einen Krankenwagen.
Please call an ambulance.

die Wunde
wound

der elektrische Schlag
electric shock

die Gehirnerschütterung
concussion

Wo haben Sie Schmerzen?
Where does it hurt?

die erste Hilfe • first aid

die Salbe
ointment

das Pflaster
adhesive
bandage

die
Sicherheitsnadel
safety pin

die Bandage
bandage

die Schmerz
tabletten
painkillers



das
Desinfektionstuch
antiseptic wipe

die Pinzette
tweezers

die Schere
scissors

das Antiseptikum
antiseptic

der Erste-Hilfe-Kasten | first aid box

die Gaze
gauze



der Verband
dressing



die Schiene | splint



das Leukoplast
adhesive tape



die Wiederbelebung
resuscitation

Vokabular • vocabulary

der Schock
shock

der Puls
pulse

ersticken
choke (v)

Können Sie mir helfen?
Can you help?

bewusstlos
unconscious

die Atmung
breathing

steril
sterile

Beherrschen Sie die
Erste Hilfe?
Do you know first aid?

das Krankenhaus • hospital



die Blutuntersuchung
blood test



die Spritze
injection

der Operationssaal
operating room

die fahrbare Liege
gurney



die Notaufnahme
emergency room

der Rufknopf
call button



die Krankenhausstation
ward



der Rollstuhl
wheelchair



die Röntgenaufnahme
X-ray

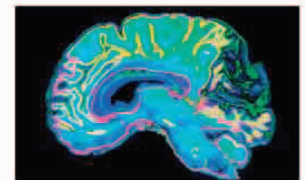

der CT-Scan
scan

Vokabular • vocabulary

die Operation operation	entlassen discharged	die Besuchszeiten visiting hours	die Entbindungsstation maternity ward	die Intensivstation intensive care unit
aufgenommen admitted	die Klinik clinic	die Kinderstation children's ward	das Privatzimmer private room	der ambulante Patient outpatient

die Abteilungen • departments



die HNO-Abteilung
ENT (otolaryngology)



die Kardiologie
cardiology



die Orthopädie
orthopedics



die Gynäkologie
gynecology



die Physiotherapie
physiotherapy



die Dermatologie
dermatology



die Pädiatrie
pediatrics



die Radiologie
radiology



die Chirurgie
surgery



die
Entbindungsstation
maternity



die Psychiatrie
psychiatry



die Ophthalmologie
ophthalmology

Vokabular • vocabulary

die Neurologie
neurology

die Urologie
urology

die plastische Chirurgie
plastic surgery

die Pathologie
pathology

das Ergebnis
result

die Onkologie
oncology

die Endokrinologie
endocrinology

die Überweisung
referral

die Untersuchung
test

der Facharzt
specialist

der Zahnarzt • dentist

der Zahn • tooth

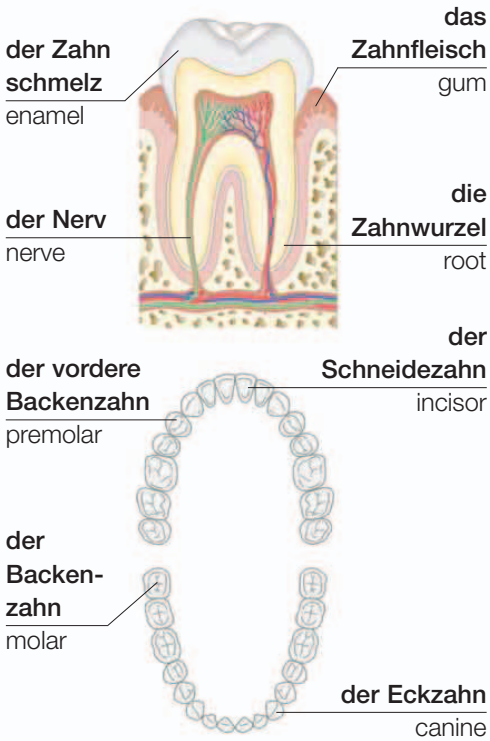

der Check-up • checkup



Vokabular • vocabulary

der Zahnbelag plaque	der Bohrer drill
die Karies decay	die Zahnseide dental floss
die Zahnfüllung filling	die Extraktion extraction
die Zahnschmerzen toothache	die Krone crown



mit Zahnseide reinigen
floss (v)



bürsten
brush



die Zahnspange
brace



die Röntgenaufnahme
dental X-ray



das Röntgenbild
X-ray film



die Zahnprothese
dentures

der Augenoptiker • optometrist



der Sehtest | eye test

das Futteral
case



die Brille
glasses

das Glas
lens



die Sonnenbrille
sunglasses

das Brillengestell
frame

das Reinigungsmittel
cleaning fluid



das Desinfektionsmittel
disinfectant solution

der Kontaktlinsen
behälter
lens case



die Kontaktlinsen | contact lenses

das Auge • eye

die Augenbraue
eyebrow

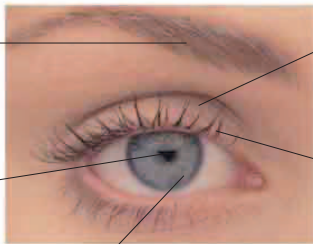

das Lid
eyelid

die Pupille
pupil

die Wimper
eyelash

die Iris
iris

die Linse
lens

die Netzhaut
retina

die Hornhaut
cornea

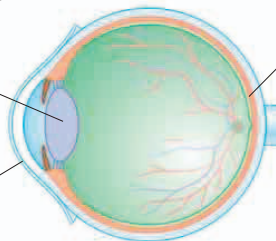

der Sehnerv
optic nerve

Vokabular • vocabulary

die Sehkraft
vision

der Astigmatismus
astigmatism

die Dioptrie
diopter

die Weitsichtigkeit
farsightedness

die Träne
tear

die Kurzsichtigkeit
nearsightedness

der graue Star
cataract

Bifokal-
bifocal

die Schwangerschaft • pregnancy



der Schwangerschaftstest
pregnancy test

die Ultraschallaufnahme
scan



der Ultraschall | ultrasound

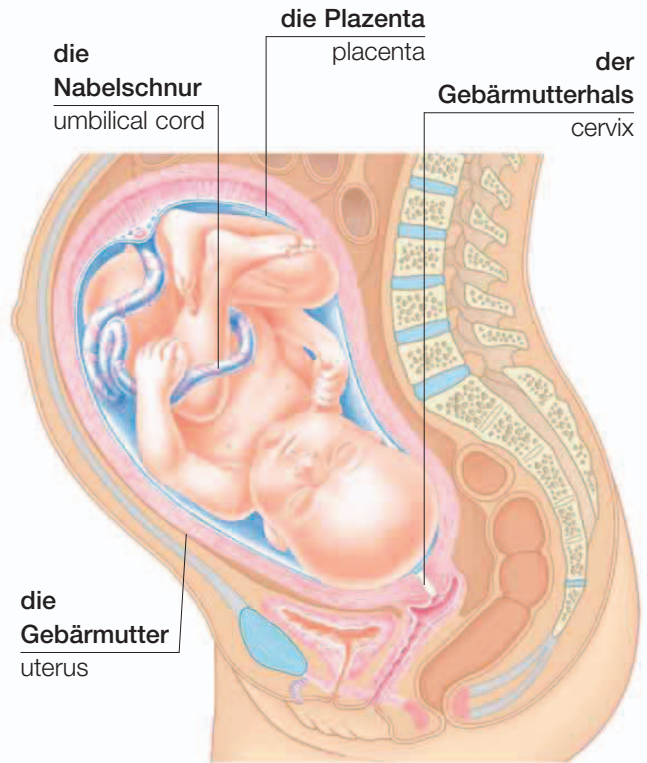

die Nabelschnur
umbilical cord

die Plazenta
placenta

der Gebärmutterhals
cervix

die Gebärmutter
uterus

der Fetus | fetus

Vokabular • vocabulary

der Eisprung ovulation	vorgeburtlich prenatal	das Fruchtwasser amniotic fluid	die Erweiterung dilation	die Naht stitches	Steiß- brech
schwanger pregnant	der Embryo embryo	die Amniozentese amniocentesis	der Kaiserschnitt cesarean section	die Geburt birth	vorzeitig premature
die Empfängnis conception	die Gebärmutter womb	das Fruchtwasser geht ab break water (v)	die Periduralanästhesie epidural	die Entbindung delivery	der Gynäkologe gynecologist
schwanger expecting	das Trimester trimester	die Wehe contraction	der Dammschnitt episiotomy	die Fehlgeburt miscarriage	der Geburtshelfer obstetrician

die Geburt • childbirth

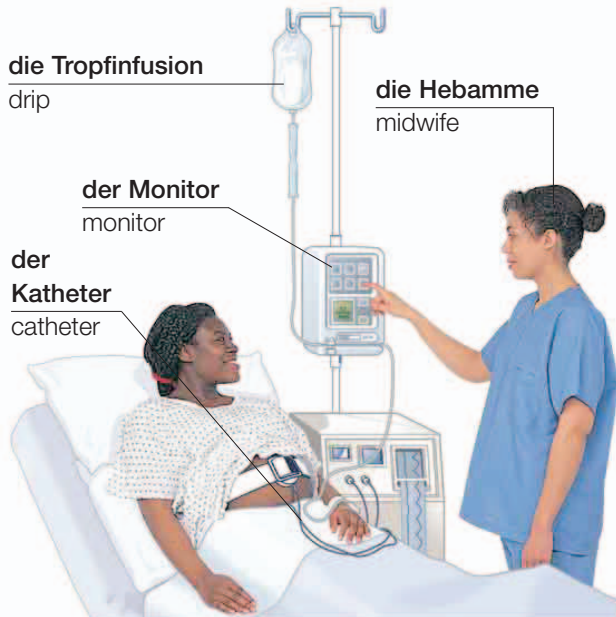

die Tropfinfusion
drip

die Hebamme
midwife

der Monitor
monitor

der
Katheter
catheter

die Geburt einleiten
induce labor (v)



der Brutkasten | incubator



das Geburtsgewicht
birth weight

die Geburtszange
forceps

die Saugglocke
suction cup

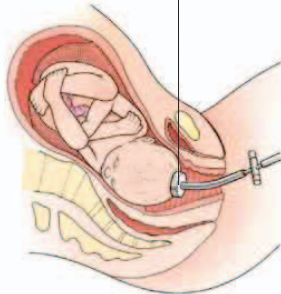
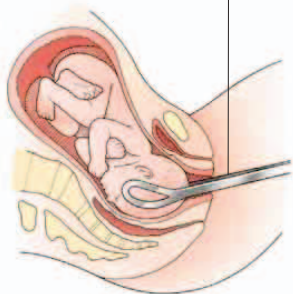

die assistierte Entbindung
assisted delivery

das Erkennungsetikett
identity tag



das Neugeborene
newborn baby

das Stillen • nursing



die Brustpumpe
breast pump



der Stillbüstenhalter
nursing bra



stillen
breastfeed (v)



die Einlagen
pads

die Alternativtherapien • complementary therapy



das Yoga | yoga



die Massage
massage



das Shiatsu
shiatsu



die Chiropraktik
chiropractic



die Osteopathie
osteopathy



die Reflexzonenmassage
reflexology



die Meditation
meditation

der Berater
counselor



die Gruppentherapie
group therapy



das Reiki
reiki



die Akupunktur
acupuncture



das Ayurveda
ayurveda



die Hypnotherapie
hypnotherapy

die ätherischen Öle
essential oils



die Kräuterheilkunde
herbalism



die Aromatherapie
aromatherapy



die Homöopathie
homeopathy



die Akupressur
acupressure

die Therapeutin
therapist



die Psychotherapie
psychotherapy

Vokabular • vocabulary

die
Kristalltherapie
crystal healing

die
Naturheilkunde
naturopathy

die
Entspannung
relaxation

das
Heilkraut
herb

die Wasserbe-
handlung
hydrotherapy

das Feng Shui
feng shui

der Stress
stress

die
Ergänzung
supplement





das Haus
home

das Haus • house

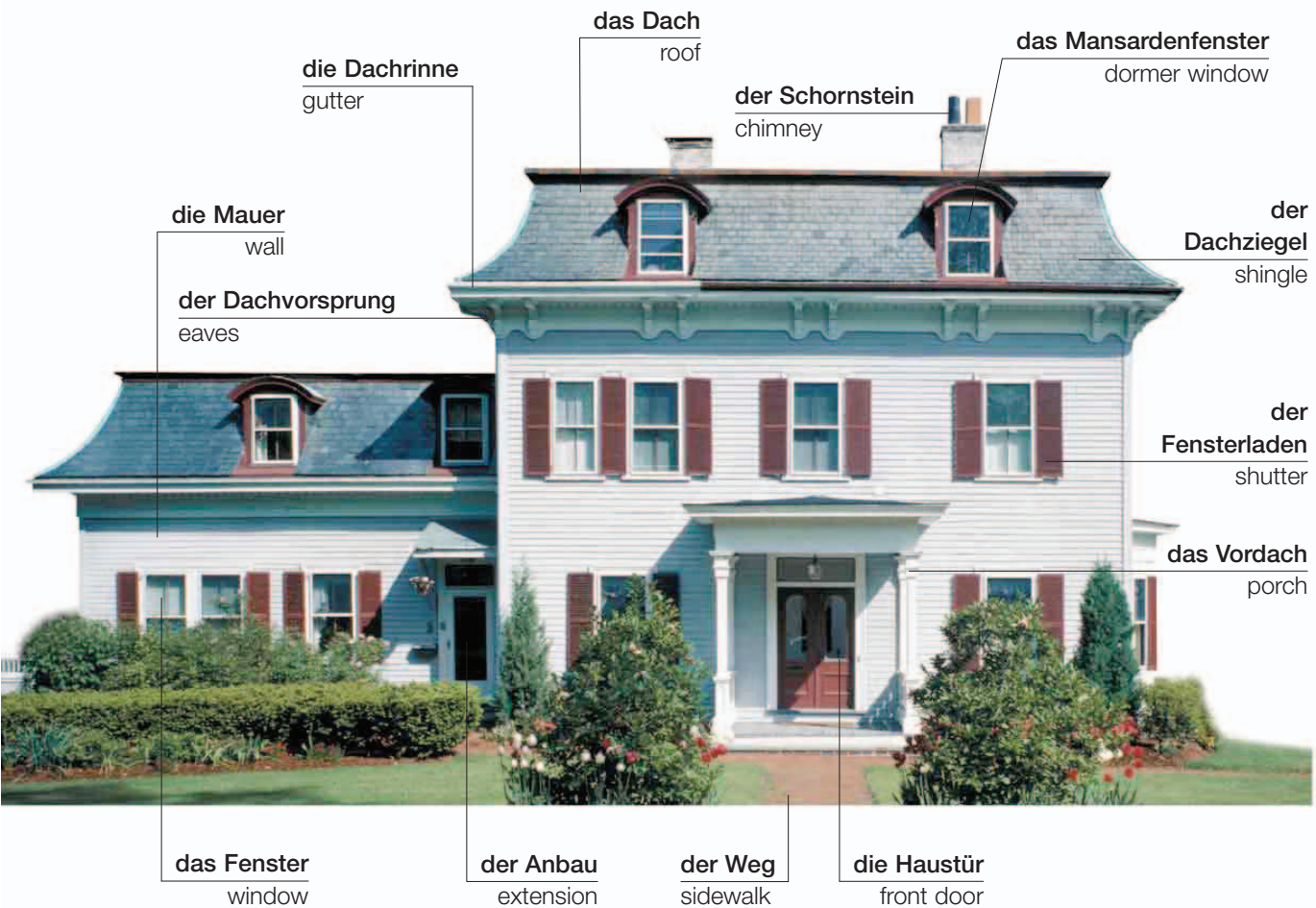

Vokabular • vocabulary

Einzel(haus) single-family	Reihen(haus) row house	die Garage garage	das Stockwerk floor	die Alarmanlage burglar alarm	mieten rent (v)
Doppel(haus) duplex	der Bungalow ranch house	das Zimmer room	der Hof courtyard	der Briefkasten mailbox	die Miete rent
das dreistöckige Haus townhouse	das Kellergeschoss basement	der Dachboden attic	die Haustürleuchte porch light	der Vermieter landlord	der Mieter tenant

der Eingang • entrance



das
Geländer
hand rail

die Treppe
staircase

der Treppen-
absatz
landing

das Treppen-
geländer
banister

die Diele
foyer



die Türklingel
doorbell



der Fußabtreter
doormat



der Türklopfer
door knocker



die Türkette
door chain

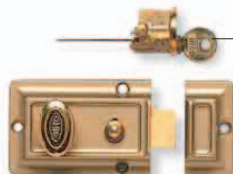

das Schloss
lock

der Schlüssel
key



der Türriegel
bolt

die Wohnung • apartment



der Balkon
balcony

der Wohnblock
apartment building



die Sprechanlage
intercom



der Fahrstuhl
elevator

die Hausanschlüsse • internal systems



der Heizkörper
radiator



der Heizofen
space heater



der Flügel
blade

der Ventilator
fan



der Heizlüfter
convector heater

die Elektrizität • electricity



der Glühfaden
filament

die Energiesparbirne
energy-saving bulb

die Erdung
ground



der Stecker
plug



der Pol
pin

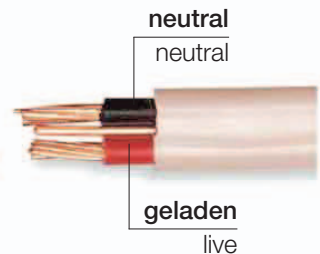

neutral
neutral

geladen
live

die Leitung
wires

Vokabular • vocabulary

die Spannung
voltage

die Sicherung
fuse

die Steckdose
outlet

der Gleichstrom
direct current

der Transformator
transformer

das Ampère
amp

der Generator
generator

der Schalter
switch

der Stromzähler
electric meter

das Stromnetz
household current

der Strom
power

der Sicherungskasten
fuse box

der Wechselstrom
alternating current

der Stromausfall
power outage

die Installation • plumbing

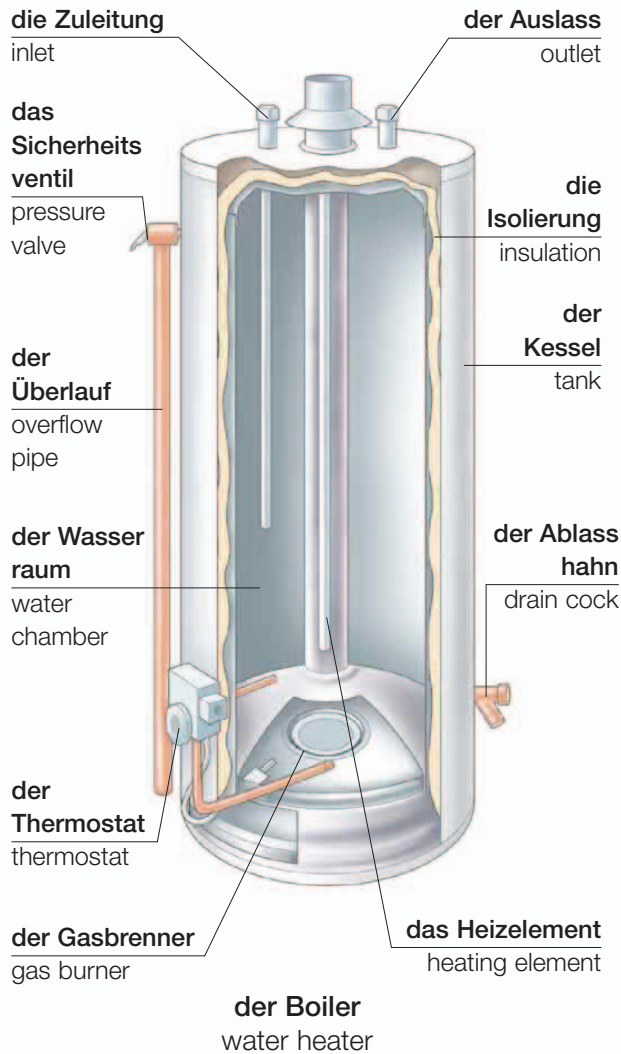

die Spüle • sink

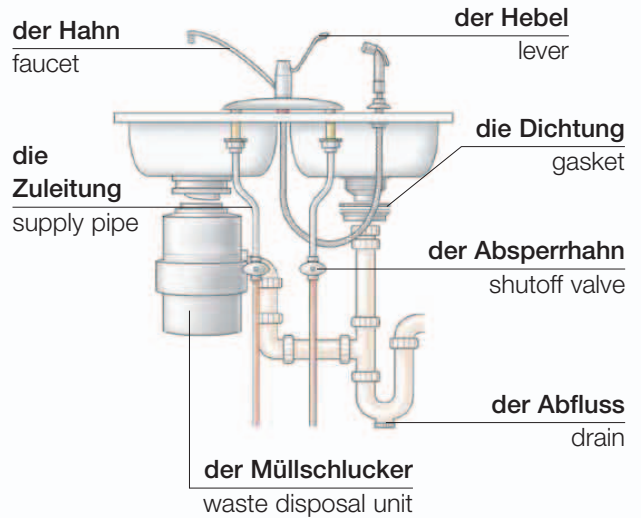

das WC • toilet

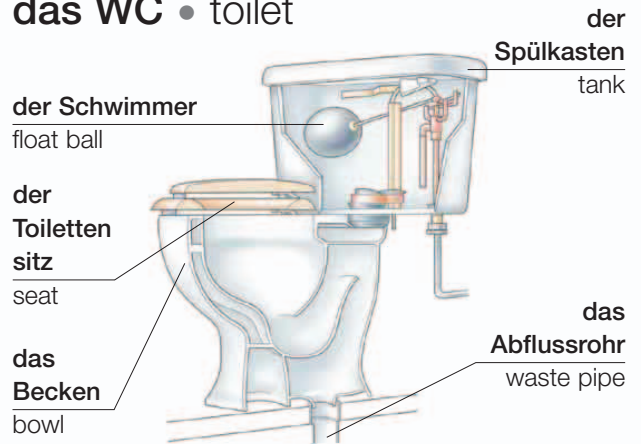

die Abfallentsorgung • waste disposal

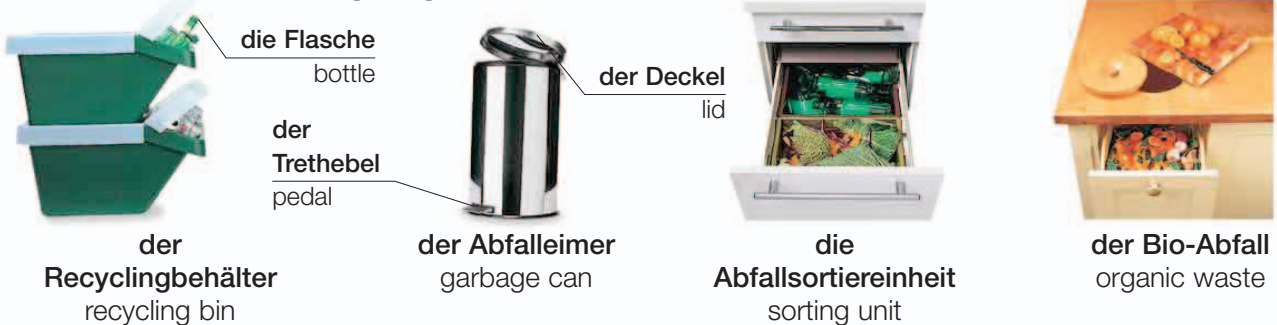

das Wohnzimmer • living room

die Decke
ceiling

die Vase
vase

das
Sofakissen
cushion

die Lampe
lamp

der
Couchtisch
coffee table

das Sofa
sofa

der
Fußboden
floor

die Wandlampe
wall light

der Kamin
fireplace



der
Bilderrahmen
frame



das Gemälde
painting

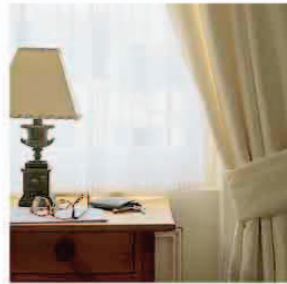

der Vorhang
curtain



die Gardine
net curtain



die Jalousie
venetian blind



das Rollo
roller shade

der Stuck
molding

der Sessel
armchair

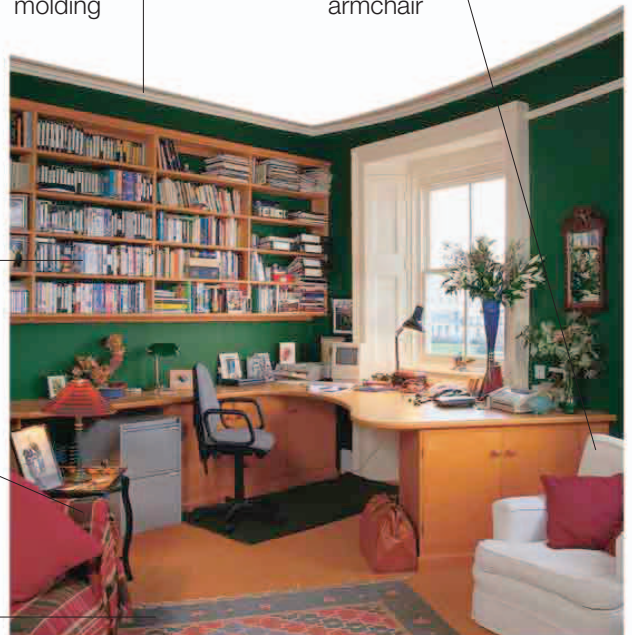

das Bücherregal
bookshelf

die
Bettcouch
sofabed

der Teppich
rug

das Arbeitszimmer | study

das Esszimmer • dining room



Vokabular • vocabulary

die Tischdecke
tablecloth

die Gastgeberin
hostess

die Portion
portion

den Tisch decken
set the table
(v)

das Frühstück
breakfast

Könnte ich bitte noch ein bisschen haben?
Can I have some more, please?

das Set
placemat

der Gast
guest

hungrig
hungry

servieren
serve (v)

das Mittagessen
lunch

Ich bin satt, danke.
I've had enough, thank you.

das Essen
meal

der Gastgeber
host

satt
full

essen
eat (v)

das Abendessen
dinner

Das war lecker.
That was delicious.

das Geschirr und das Besteck • crockery and cutlery



der Becher
mug



die Kaffeetasse
coffee cup



die Teetasse
teacup

der Teelöffel
teaspoon



der Teller
plate



die Schüssel
bowl



die Cafetière
cafetière



die Teekanne
teapot



das Kännchen
jug



der Eierbecher
egg cup

das Weinglas
wine glass

das Wasserglas
tumbler



die Glaswaren
glassware

der Serviettenring
napkin ring

der Beilagenteller
side plate

der Essteller
dinner plate

der Suppenteller
soup bowl

der Suppenlöffel
soup spoon



die Serviette
napkin



die Gabel
fork



das Gedeck
place setting



der Löffel
spoon

das Messer
knife

die Küche • kitchen



die Küchengeräte • appliances



das
Eisfach
icemaker

das
Gefrierfach
freezer



der Rost
shelf

das
Gemüsefach
crisper

der Gefrier-Kühlschrank | refrigerator

Vokabular • vocabulary

das Kochfeld **einfrieren**
range freeze (v)

das Abtropfbrett **auftauen**
drainage board defrost (v)

der Brenner **dämpfen**
burner steam (v)

der Mülleimer **anbraten**
garbage can sauté (v)

das Kochen • cooking



schälen
peel (v)



schneiden
slice (v)



reiben
grate (v)



gießen
pour (v)



verrühren
mix (v)



schlagen
whisk (v)



kochen
boil (v)



braten
fry (v)



ausrollen
roll (v)



rühren
stir (v)



köcheln lassen
simmer (v)



pochieren
poach (v)



backen
bake (v)



braten
roast (v)



grillen
broil (v)

die Küchengeräte • kitchenware



das Hackbrett
cutting board

das Brotmesser
bread knife



**das
Küchenmesser**
kitchen knife



**das
Hackmesser**
cleaver



**der Messer-
schärfer**
knife sharpener



**der
Fleischklopper**
meat tenderizer



der Spieß
skewer



die Reibe
grater



der Stößel
pestle



**der Kartoffel-
stampfer**
masher



der Schäler
vegetable peeler



der Apfelstecher
apple corer



der Dosenöffner
can opener



**der
Flaschenöffner**
bottle opener



**die
Knoblauchpresse**
garlic press



der Servierlöffel
serving spoon



**der
Pfannenwender**
slotted spatula



das Sieb
colander



der Spachtel
spatula



der Holzlöffel
wooden spoon



der Schaumlöffel
slotted spoon



der Schöpflöffel
ladle



die Tranchiergabel
carving fork



der Portionierer
ice-cream scoop



der Schneebesen
whisk



das Sieb
sieve



das Kuchenbacken • baking cakes



das Schlafzimmer • bedroom

der Kleiderschrank

wardrobe

**die
Nachtisch
lampe**

bedside lamp

das Kopfende

headboard

der Nachtisch

nightstand

die Kommode

chest of drawers



die Schublade

drawer

das Bett

bed

die Matratze

mattress

die Tagesdecke

bedspread

das

Kopfkissen

pillow



**die
Wärmflasche**
hot-water bottle



**der
Radiowecker**
clock radio



der Wecker
alarm clock



**die
Papiertaschen
tuchschachtel**
box of tissues



der Kleiderbügel
coat hanger

die Bettwäsche • bed linen



der Spiegel
mirror

der Frisiertisch
dressing table

der Fußboden
floor



der Kissenbezug
pillowcase

das Bettlaken
sheet

der Volant
dust ruffle

die Bettdecke
comforter

die Steppdecke
quilt

die Decke
blanket



Vokabular • vocabulary

das Einzelbett
twin bed

das Fußende
footboard

die Schlaflosigkeit
insomnia

aufwachen
wake up (v)

den Wecker stellen
set the alarm (v)

das Doppelbett
full bed

die Sprungfeder
spring

ins Bett gehen
go to bed (v)

aufstehen
get up (v)

schnarchen
snore (v)

die Heizdecke
electric blanket

der Teppich
carpet

einschlafen
go to sleep (v)

das Bett machen
make the bed (v)

der Einbauschränk
built-in wardrobe

das Badezimmer • bathroom

der Handtuchhalter
towel bar

die Duschtür
shower door

der Kaltwasserhahn
cold faucet

der Heißwasserhahn
hot faucet

das Waschbecken
sink

der Duschkopf
shower head

der Stöpsel
plug

die Dusche
shower

der Abfluss
drain



die Badewanne
bathtub



das Bidet | bidet



der Toilettensitz
toilet seat

die Toilette
toilet

die Toilettenbürste
toilet brush

Vokabular • vocabulary

die Hausapotheke
medicine cabinet

die Badematte
bath mat

die Rolle Toilettenpapier
toilet paper

der Duschvorhang
shower curtain

duschen
take a shower (v)

baden
take a bath (v)

die Zahnpflege • dental hygiene



die Zahnbürste
toothbrush



die Zahnseide
dental floss



die Zahnpasta
toothpaste



das Mundwasser
mouthwash

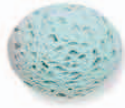

der Schwamm
sponge



der Bimsstein
pumice stone



die Rückenbürste
back brush



das Deo
deodorant

die Seifenschale
soap dish



die Seife
soap

das Duschgel
shower gel



die Gesichtscreme
face cream



das Schaumbad
bubble bath



der Bademantel
bathrobe

das Handtuch
hand towel



die Handtücher
towels

das Badetuch
bath towel



die Körperlotion
body lotion



der Körperpuder
talcum powder

das Rasieren • shaving



der Elektrorasierer
electric razor



der Rasierschaum
shaving foam



der Einwegrasierer
disposable razor



die Rasierklinge
razor blade



das Rasierwasser
aftershave

das Kinderzimmer • nursery

die Säuglingspflege • baby care



der Schwamm
sponge

die Wundsalbe
diaper rash cream

die Babywanne
baby bath



das Erfrischungstuch
wet wipe

das Töpfchen
potty



die Wickelmatte
changing mat

das Schlafen • sleeping



das Mobile
mobile

die Matratze
mattress

das Kinderbett | crib

das Laken
sheet

die Decke
blanket

die Gitterstäbe
bars

die Flauschdecke
fleece

das Bettzeug
bedding

der Kopfschutz
bumper



die Rassel
rattle



das Körbchen
bassinet

das Spielen • playing



die Sicherheit • safety

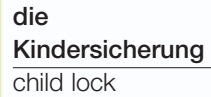

das Essen • eating



der Allzweckraum • utility room

die Wäsche • laundry

die
schmutzige
Wäsche
dirty laundry



der Wäschekorb
laundry basket



die
Waschmaschine
washing machine



der
Waschtrockner
washer-dryer



der Trockner
tumble dryer

die saubere Wäsche
clean clothes



der
Wäschekorb
linen basket

die Wäsche
klammer
clothespin



trocknen
dry (v)

die Wäscheleine
clothesline



das Bügelbrett | ironing board



das Bügeleisen
iron

Vokabular • vocabulary

füllen
load (v)

schleudern
spin (v)

bügeln
iron (v)

Wie benutze ich die Waschmaschine?
How do I operate the washing machine?

spülen
rinse (v)

die Wäscheschleuder
spin-dryer

der Weichspüler
fabric softener

Welches Programm nehme ich für
farbige/weiße Wäsche?
What is the setting for colors/whites?

die Reinigungsartikel • cleaning equipment



die Tätigkeiten • activities



die Heimwerkstatt • workshop

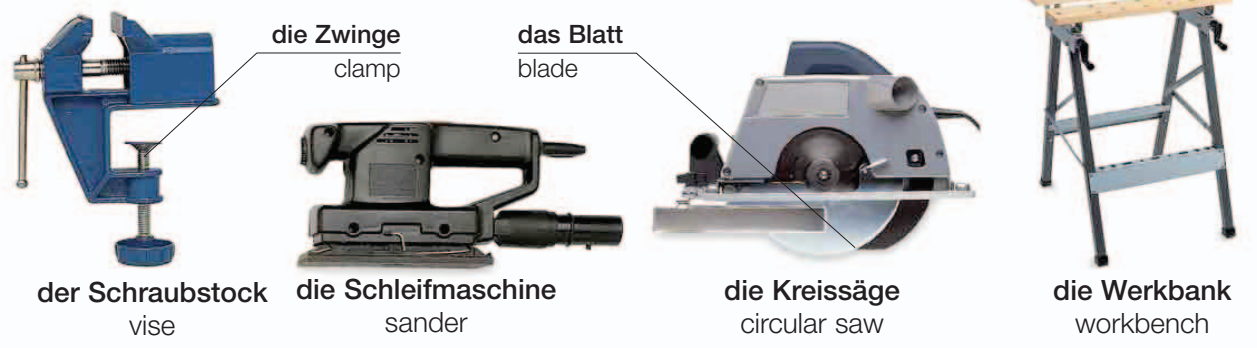

die Fertigkeiten • techniques

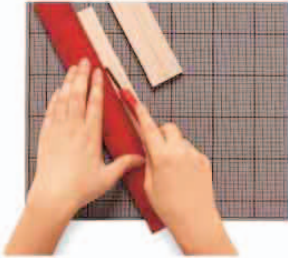

schneiden
cut (v)



sägen
saw (v)



bohren
drill (v)



hämmern
hammer (v)



hobeln
plane (v)

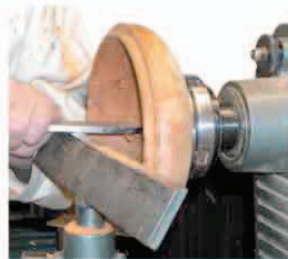

dreheln
turn (v)

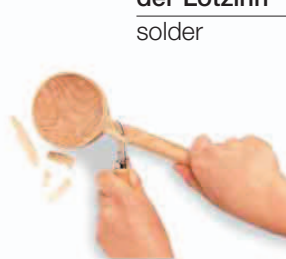

schnitzen
carve (v)

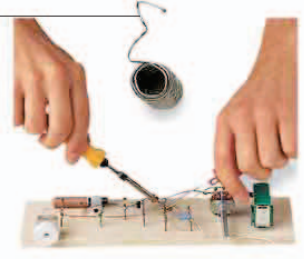

der Lötzinn
solder

löten
solder (v)

die Materialien • materials

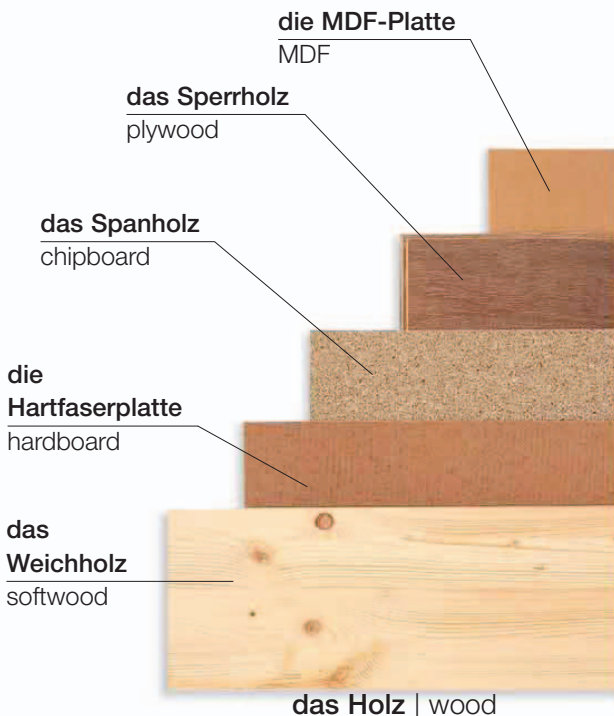

der Werkzeugkasten • toolbox

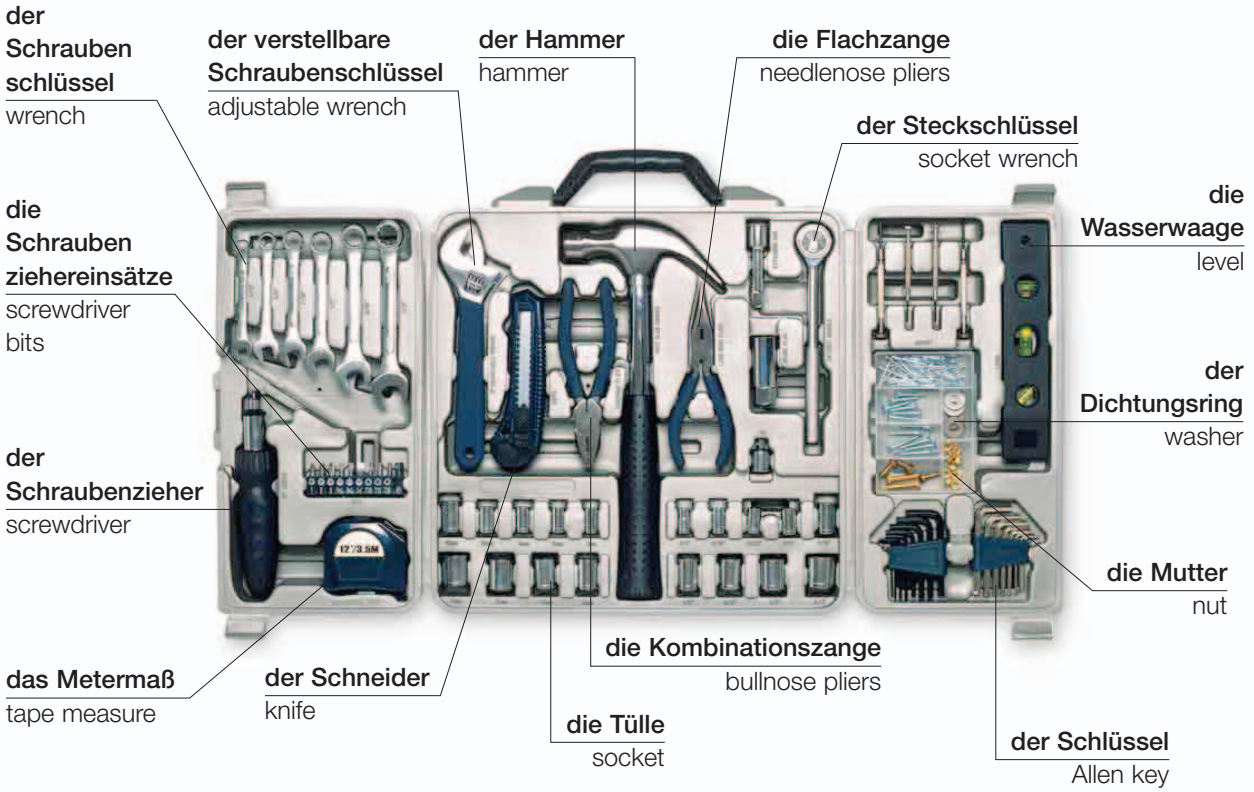

die Bohrer • drill bits

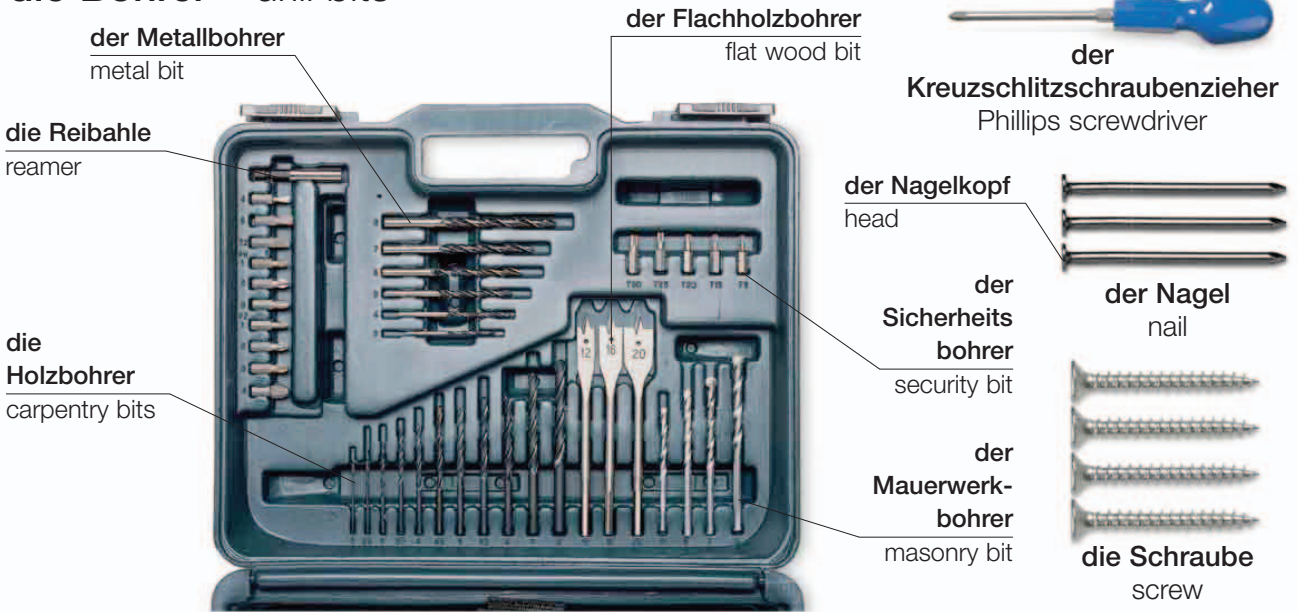

die Entisolierzange
wire strippers

der Drahtschneider
wire cutters

der LötKolben
soldering iron

das Isolierband
insulating tape

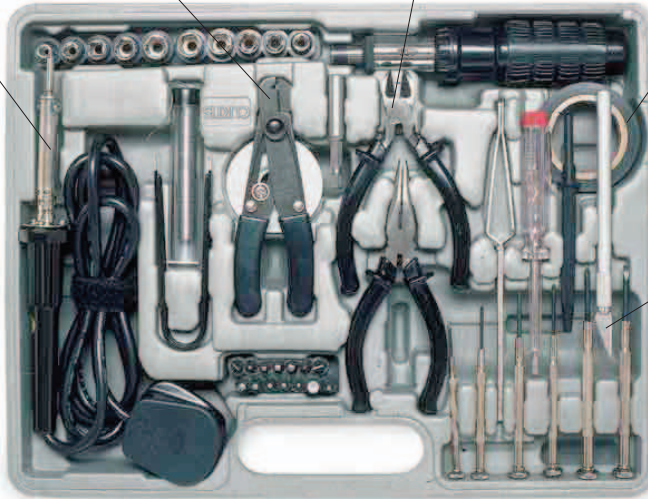

das Skalpell
craft knife

die Schweißsäge
fretsaw

der LötZinn
solder



die Profilsäge | tenon saw



die Schutzbrille
safety goggles



der Hobel
plane



die Gehrungslade
miter block



der Fuchsschwanz
handsaw



der Handbohrer
hand drill



die Stahlwolle
steel wool



die Metallsäge
hacksaw



das Schmirgelpapier
sandpaper

die RohrZange
wrench



der Meißel
chisel



der Wetzstahl
whetstone

der Sauger
plunger



die Feile
file



der Rohrabschneider | pipe cutter



das Tapezieren • decorating



die Tapezierschere
scissors



das Tapeziermesser
utility knife



das Senkblei
plumb line



der Spachtel
scraper

der Tapezierer
decorator

die Tapete
wallpaper

die Trittleiter
stepladder



die Tapezierbürste
wallpaper brush

der Tapeziertisch
pasting table

die Kleisterbürste
pasting brush

der Tapetenkleister
wallpaper paste

der Eimer
pail

tapezieren | wallpaper (v)



abziehen
strip (v)



spachteln
fill (v)



schmirlen
sand (v)



verputzen | plaster (v)



anbringen | hang (v)



kacheln | tile (v)



anstreichen
paint (v)

der Roller
roller

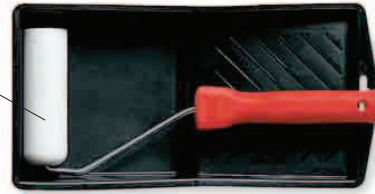

die Wanne
paint tray



die Farbe
paint

die Streichbürste
brush

der Farbtopf
paint can



der Schwamm
sponge



das Abdeckband
masking tape



**das Schmirgel
papier**
sandpaper

der Overall
overalls



die Spachtelmasse
filler

das Terpentin
turpentine



das Verdünnungsmittel
mineral spirits

das Abdecktuch
dustsheet

Vokabular • vocabulary

der Gips
plaster

Glanz-
gloss

das Relieftapete
embossed paper

die Grundierung
undercoat

das Lösungsmittel
solvent

der Lack
varnish

matt
mat

die Grundfarbe
primer

der Fugenkitt
grout

der Deckanstrich
topcoat

die Emulsionsfarbe
latex paint

die Schablone
stencil

das Einsatzpapier
lining paper

der Schutzanstrich
preservative

das Versiegelungsmittel
sealant

der Garten • garden

die Gartentypen • garden styles



der Patio
patio garden



der Dachgarten
roof garden



der Steingarten
rock garden



der Hof
courtyard



der architektonische Garten | formal garden



der Bauerngarten
cottage garden



der Kräutergarten
herb garden



der Wassergarten
water garden

die Garten ornamente • garden features



die Blumenampel
hanging basket



das Spalier
trellis



die Pergola
pergola

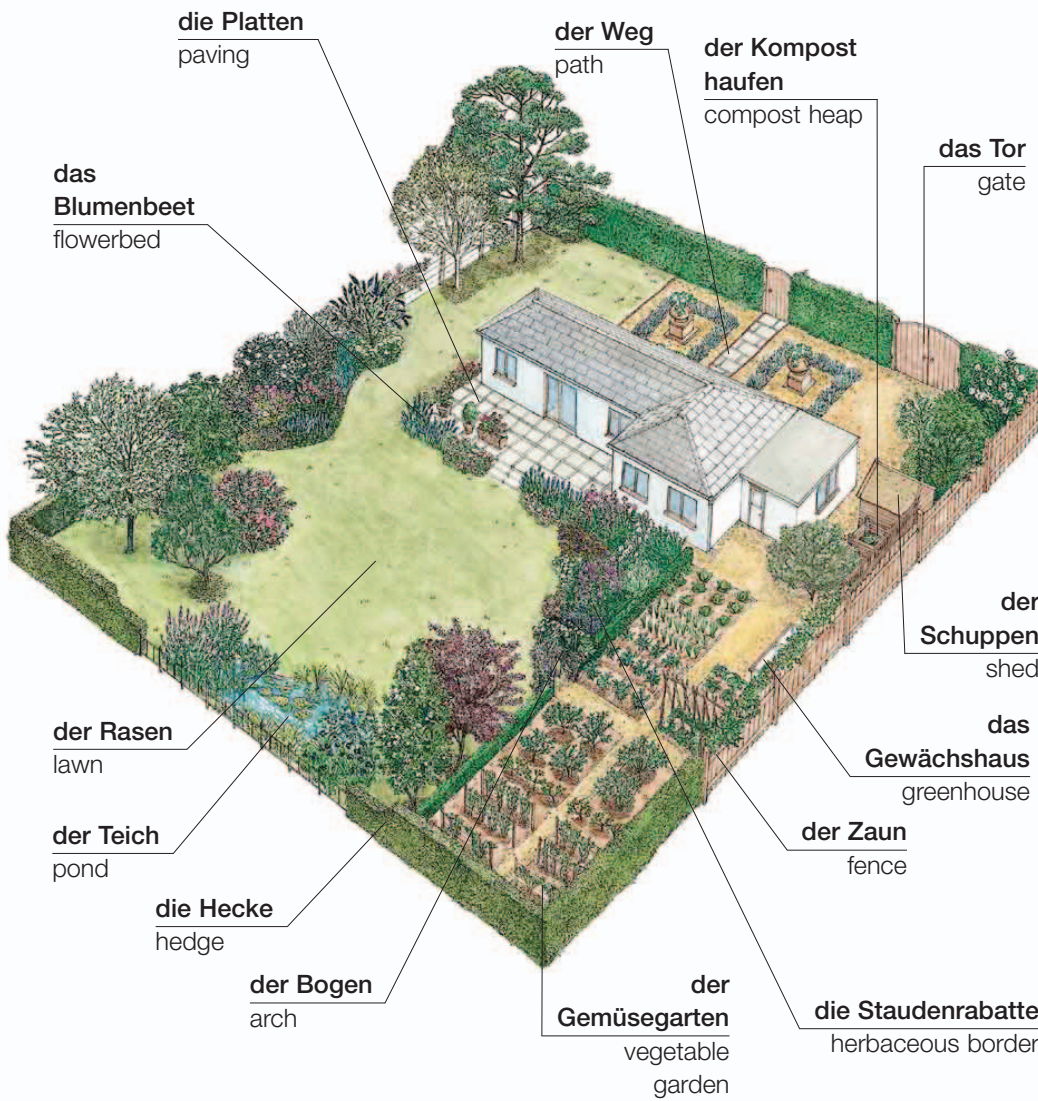

der Boden

• soil



die Erde
topsoil



der Sand
sand



der Kalk
chalk



der Schlick
silt



der Lehm
clay



die Planken
decking



der Springbrunnen | fountain

die Gartenpflanzen • garden plants

die Pflanzenarten • types of plants



einjährig
annual



zweijährig
biennial



mehrfährig
perennial



die Zwiebel
bulb



der Farn
fern



die Binse
rush



der Bambus
bamboo



das Unkraut
weeds



das Kraut
herb



die Wasserpflanze
water plant



der Baum
tree



die Palme
palm



der Nadelbaum
conifer



immergrün
evergreen



der Laubbaum
deciduous



der Formschnitt
topiary



die Alpenpflanze
alpine



die Fettpflanze
succulent



der Kaktus
cactus

die Topfpflanze
potted plant

die Schattenpflanze
shade plant

die Kletterpflanze
climber

der Zierstrauch
flowering shrub

der Bodendecker
ground cover



die Kriechpflanze
creeper

Zier-
ornamental

das Gras
grass

die Gartengeräte • garden tools



der Spaten
spade



die Gabel
fork



die Schere
long-handled shears



der Laubrechen
lawn rake



der Rechen
rake



die Hacke
hoe



die Komposterde
compost



die Samen
seeds

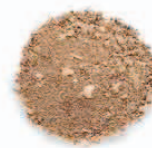

die Knochenasche
bone meal



der Kies
gravel

der Grasfangsack
grass bag

der Motor
motor

der Griff
handle



der Gartenkorb
trug



der Schutz
shield

der Schneider
trimmer

der Rasenmäher
lawnmower



der Ständer
stand

der Schubkarren
wheelbarrow



die Handgabel
hand fork



die Rosenschere
pruners

die Gartenhandschuhe
gardening gloves



die Pflanzschaufel
trowel



der Setzkasten
seed tray

das Messer
blade

der Zwirn
twine

die Pflanzschildchen
labels

die Befestigungen
twist ties



die Heckenschere
shears



das Pestizid
pesticide

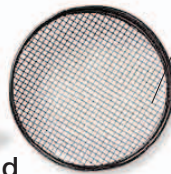

das Sieb
sieve

die Ringbefestigungen
ring ties

die Garten
stöcke
canes



die Handsäge
hand saw



der Blumentopf
plant pot



die Gummistiefel
rubber boots

das Gießen • watering



die Gartenspritze
spray bottle



der
Rasensprenger
sprinkler

die Düse
nozzle

die Gießkanne
watering can

der Gartenschlauch
hose

die Brause
rose

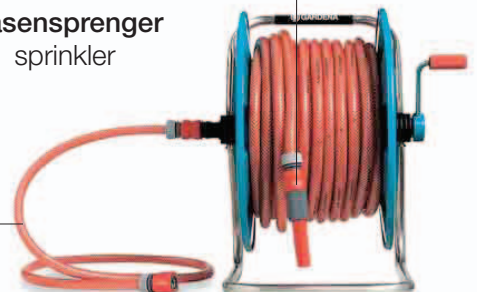

der Schlauchwagen | hose reel

die Gartenarbeit • gardening

der Rasen
lawn

das
Blumenbeet
flowerbed

der
Rasenmäher
lawnmower



die Hecke
hedge

die Stange
stake

mähen | mow (v)



mit Rasen bedecken
turf (v)



stechen
spike (v)



harken
rake (v)



stutzen
trim (v)



graben
dig (v)



säen
sow (v)



mit Kopfdünger
düngen
topdress (v)



gießen
water (v)



ziehen
train (v)



köpfen
deadhead (v)

sprühen
spray (v)



der Stock
cane

hochbinden
stake (v)



pfpflanzen
graft (v)



der Ableger
cutting

vermehren
propagate (v)



beschneiden
prune (v)



umpflanzen
transplant (v)



jäten
weed (v)



mulchen
mulch (v)



ernten
harvest (v)

Vokabular • vocabulary

züchten cultivate (v)	gestalten landscape (v)	düngen fertilize (v)	sieben sift (v)	biodynamisch organic	die Entwässerung drainage	der Dünger fertilizer
hegen tend (v)	eintopfen pot (v)	pflücken pick (v)	auflockern aerate (v)	der Untergrund subsoil	der Unkrautvernichter weedkiller	der Sämling seedling



JKL

5

TUV

7

8

SYMBOL

0



die Dienstleistungen
services

die Dienstleistungen • emergency services

die Notdienste • ambulance



der Krankenwagen
ambulance



der Rettungsanwärter
paramedic

die Tragbahre
stretcher

die Polizei • police

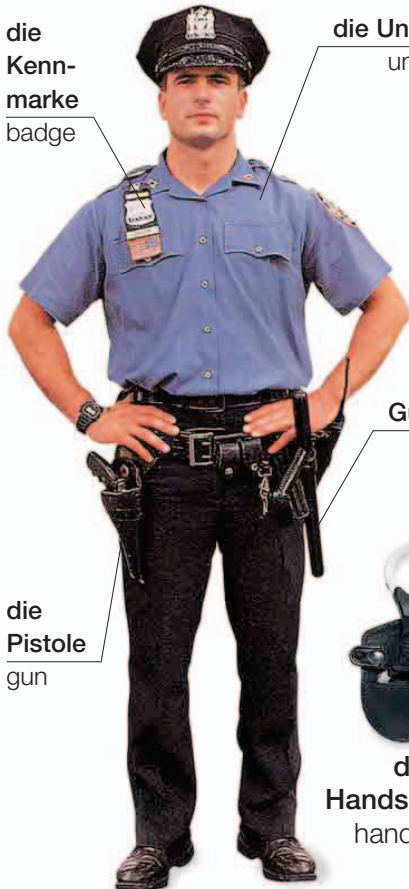

die Kenn-
marke
badge

die Uniform
uniform

die Sirene
siren

das Licht
lights

der
Gummiknüppel
nightstick

die
Pistole
gun



die
Handschellen
handcuffs

der Polizist
police officer



das Polizeiauto
police car



die Polizeiwache
police station

Vokabular • vocabulary

der
Inspektor
inspector

das
Verbrechen
crime

die
Beschwerde
complaint

die
Festnahme
arrest

der Kriminal-
beamte
detective

der Einbruch-
diebstahl
burglary

die
Ermittlung
investigation

die
Anklage
charge

die
Polizeizelle
cell

die Körperver-
letzung
assault

der
Verdächtige
suspect

der Finger
abdruck
fingerprint

die Feuerwehr • fire department



der Brand | fire



die Feuerwache
fire station



die Feuertreppe
fire escape



der Schutzhelm
helmet

der Rauch
smoke

der Schlauch
hose

der Auslegerkorb
basket

die Feuerwehrleute
firefighters

der Wasserstrahl
water jet

der Ausleger
boom

die Leiter
ladder

die Fahrkabine
cab

das Löschfahrzeug
fire engine



der Rauchmelder
smoke alarm



der Feuermelder
fire alarm



das Beil
ax



der Feuerlöscher
fire extinguisher



der Hydrant
hydrant

Die Polizei/die Feuerwehr/einen Krankenwagen, bitte.
I need the police/fire department/ambulance.

Es brennt in...
There's a fire at...

Es ist ein Unfall passiert.
There's been an accident.

Rufen Sie die Polizei!
Call the police!

die Bank • bank

der Kunde
customer

der Schalter
window

der Kassierer
teller



die Broschüren
brochures

der Schalter
counter

die Einzahlungs
scheine
deposit slips

die EC-Karte
debit card

der
Abschnitt
stub

die
Kontonummer
account number

die
Unterschrift
signature

der Betrag
amount



der Filialleiter
bank manager



die Kreditkarte
credit card



das Scheckheft
checkbook

der Scheck
check

Vokabular • vocabulary

die Steuer
tax

die Hypothek
mortgage

die Zahlung
payment

einzahlen
deposit (v)

das Girokonto
checking
account

das Darlehen
loan

der Zinssatz
interest rate

der Einzugsauftrag
automatic payment

die Bankgebühr
bank charge

das Sparkonto
savings account

die
Spareinlagen
savings

die
Kontoüberziehung
overdraft

das
Abhebungsformular
withdrawal slip

die
Banküberweisung
electronic transfer

der PIN-Kode
PIN

die Münze
coin



der Schein
bill

das Geld
money

der
Bildschirm
screen

das
Tastenfeld
key pad



der
Kartenschlitz
card slot

der Geldautomat
ATM

die Wahrung • currency

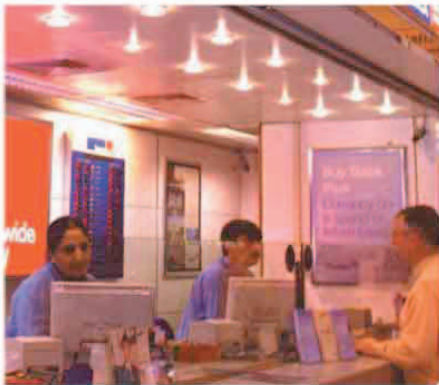

die Wechselstube
bureau de change



der Reisescheck
traveler's check



der Wechselkurs
exchange rate

Vokabular • vocabulary

einlösen
cash (v)

die Aktien
shares

der Nennwert
denomination

die Gewinnanteile
dividends

die Provision
commission

das Portefeuille
portfolio

die Wertpapiere
stocks

die Stammaktie
equity

die
Kapitalanlage
investment

der
Wirtschaftsprüfer
accountant

die ausländische
Wahrung
foreign currency

Könnte ich das bitte wechseln?
Can I change this, please?

Wie ist der heutige Wechselkurs?
What's today's exchange rate?

die Geldwirtschaft • finance

der Aktienpreis
share price

der
Börsenmakler
stockbroker



die Finanzberaterin
financial advisor



die Börse | stock exchange

die Kommunikation • communications

der Postbeamte
postal worker

der Schalter
window

die Waage
scale

der Schalter
counter



die Post | post office



der Briefträger
mail carrier

der Poststempel
postmark

die Briefmarke
stamp

die Adresse
address

die Postleitzahl
ZIPcode



der Umschlag | envelope

Vokabular • vocabulary

der Brief
letter

der Absender
return address

die Zustellung
delivery

zerbrechlich
fragile

nicht falten
do not bend (v)

per Luftpost
by airmail

die Unterschrift
signature

die Postgebühr
postage

der Postsack
mailbag

oben
this way up

das Einschreiben
registered mail

die Leerung
pickup

die Postanweisung
money order

das Telegramm
telegram

das Fax
fax



der Briefkasten
mailbox



der Hausbriefkasten
letter slot



das Paket
package



der Kurierdienst
courier

das Telefon • telephone

der Hörer
handset

die Basis
base station



der Anrufbeantworter
answering machine

das schnurlose Telefon
cordless phone



das Fernsehtelefon
video phone



die Telefonzelle
telephone booth



das Smartphone
smartphone



das Handy
mobile phone

das Tastenfeld
keypad



der Hörer
receiver

die Münzrückgabe
coin return

der Münzfernsprecher
payphone

Vokabular • vocabulary

abheben
answer (v)

wählen
dial (v)

das R-Gespräch
collect call

die App
app

die Auskunft
directory
assistance

die SMS
text (SMS)

die Sprachmitteilung
voice message

besetzt
busy

unterbrochen
disconnected

die Vermittlung
operator

der Passcode
passcode

Können Sie mir die Nummer für...geben?
Can you give me the number for...?

Was ist die Vorwahl für...?
What is the area code for...?

Schick mir eine SMS!
Text me!

das Hotel • hotel

die Empfangshalle • lobby



der Empfang | reception



der Hoteldiener
porter

das
Gepäck
luggage

der Kofferkuli
cart



der Fahrstuhl
elevator



die Zimmernummer
room number

die Zimmer • rooms



das Einzelzimmer
single room

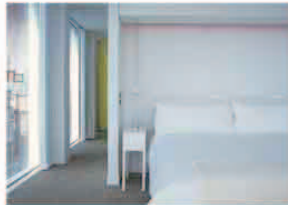

das Doppelzimmer
double room



das Zweibettzimmer
twin room



das
Privatbadezimmer
private bathroom

die Dienstleistungen • services



die Zimmerreinigung
maid service



der Wäschedienst
laundry service

das Frühstückstablett

breakfast tray



der Zimmerservice | room service



die Minibar
mini bar



das Restaurant
restaurant



der Fitnessraum
gym



das Schwimmbad
swimming pool

Vokabular • vocabulary

die Vollpension
full board

Haben Sie ein Zimmer frei?
Do you have any vacancies?

Ich möchte ein Zimmer für drei
Nächte.

I'd like a room for three nights.

die Halbpension
half-board

Ich möchte ein Einzelzimmer.
I'd like a single room.

Was kostet das Zimmer pro Nacht?
What is the charge per night?

die Übernachtung mit
Frühstück
bed and breakfast

Ich habe ein Zimmer
reserviert.
I have a reservation.

Wann muss ich das Zimmer
räumen?

When do I have to check out?





der Einkauf
shopping

das Einkaufszentrum • shopping center

das Atrium
atrium

das Schild
sign

der
Fahrstuhl
elevator



die zweite
Etage
third floor

die erste
Etage
second
floor

die Rolltreppe
escalator

das
Erdgeschoss
ground floor

der Kunde
customer

Vokabular • vocabulary

die Kinderabteilung
children's department

die Gepäckabteilung
luggage department

die Schuhabteilung
shoe department

der Kundendienst
customer services

die Anzeigetafel
store directory

der Verkäufer
sales clerk

die Anprobe
changing rooms

der Wickelraum
baby-changing facilities

die Toiletten
restrooms

Was kostet das?
How much is this?

Kann ich das
umtauschen?
May I exchange this?

das Kaufhaus • department store



die Herrenbekleidung
menswear



die Damenoberbekleidung
women's clothing



die Damenwäsche
lingerie



die Parfümerie
perfume



die Schönheitspflege
beauty



die Wäsche
linen



die Möbel
home furnishings



die Kurzwaren
notions



die Küchengeräte
kitchenware



das Porzellan
china



die Elektroartikel
electrical goods



die Lampen
lighting



die Sportartikel
sports



die Spielwaren
toys



die Schreibwaren
stationery



die Lebensmittelabteilung
food

der Supermarkt • supermarket

der Gang
aisle

das
Warenregal
shelf

das Laufband
conveyer belt

der Kassierer
checker

die
Angebote
specials



die Kasse | checkout

der Kunde
customer

die Kasse
cash register

die
Einkaufstasche
shopping bag



der Einkaufswagen
cart

die
Lebensmittel
groceries

der Henkel
handle



der Einkaufskorb
basket



der Strichcode
bar code



der Scanner
scanner



die Backwaren
bakery



die Milchprodukte
dairy



die Getreideflocken
cereals



die Konserven
canned food



die Süßwaren
confectionery



das Gemüse
vegetables



das Obst
fruit



das Fleisch und das Geflügel
meat and poultry



der Fisch
fish



die Feinkost
deli



die Gefrierware
frozen food



die Fertiggerichte
convenience food



die Getränke
drinks



die Haushaltswaren
household products



die Toilettenartikel
toiletries



die Babyprodukte
baby products



die Elektroartikel
electrical goods



das Tierfutter
pet food



die Zeitschriften | magazines

die Apotheke • pharmacy

die Zahnpflege
dental care

die Monats-
hygiene
feminine
hygiene

die Deos
deodorants

die
Vitamin-tabletten
vitamins

die Apotheke
pharmacy

der Apotheker
pharmacist

das
Hustenmedikament
cough medicine

das Kräuterheilmittel
herbal remedies

die Hautpflege
skin care



die After-
Sun-Lotion
aftersun



die Sonnenschutzcreme
sunscreen

der Sonnenblock
sunblock



das
Insektenschutzmittel
insect repellent



das Reinigungstuch
wet wipe



das Papiertaschentuch
tissue



die Damenbinde
sanitary napkin



der Tampon
tampon



die Slipeinlage
panty liner



die Kapsel
capsule



die Pille
pill

der Messlöffel
measuring spoon



der Saft
syrup

die Gebrauchs-
anweisung
instructions



der Inhalierstift
inhaler



die Creme
cream



die Salbe
ointment



das Gel
gel



das Zäpfchen
suppository



die Tropfen
drops

der Tropfer
dropper



die Spritze
syringe

die Nadel
needle



der Spray
spray



der Puder
powder

Vokabular • vocabulary

das Eisen
iron

das Multivitaminmittel
multivitamins

Wegwerf-
disposable

das Medikament
medicine

das Schmerzmittel
painkiller

das Kalzium
calcium

die Nebenwirkungen
side-effects

löslich
soluble

der Durchfall
diarrhea

das Beruhigungsmittel
sedative

das Insulin
insulin

das Verfallsdatum
expiration date

die Dosierung
dosage

die Halspastille
cough drop

die Schlaftablette
sleeping pill

das
Magnesium
magnesium

die
Reisekrankheitstabletten
travel-sickness pills

die
Verordnung
medication

das
Abführmittel
laxative

der
Entzündungshemmer
anti-inflammatory

das Blumengeschäft • florist

die Blumen
flowers

die Lilie
lily

die Akazie
acacia

die Nelke
carnation

die Topfpflanze
potted plant



die Gladiole
gladiolus

die Iris
iris

die Margerite
daisy

die
Chrysantheme
chrysanthemum

das
Schleierkraut
gypsophila



die Levkoje
stocks



die Gerbera
gerbera



die Blätter
foliage



die Rose
rose



die Freesie
freesia

die
Blumenvase
vase



die Orchidee
orchid



die Pfingstrose
peony

der Strauß
bunch



der Stengel
stem

die Osterglocke
daffodil

die Knospe
bud



das Einwickelpapier
wrapping

die Tulpe | tulip

die Blumenarrangements • arrangements



das Band
ribbon

das Bukett
bouquet



die Trockenblumen
dried flowers



das Duftsträußchen | potpourri



der Kranz | wreath



die Blumengirlande
garland

Ich möchte einen Strauß..., bitte.

Can I have a bunch of... please.

Können Sie die Blumen bitte einwickeln?

Can I have them wrapped?

Kann ich eine Nachricht mitschicken?

Can I attach a message?

Wie lange halten sie?

How long will these last?

Duften sie?

Are they fragrant?

Können Sie die Blumen an... schicken?

Can you send them to...?

der Zeitungshändler • newsstand



die Zigaretten
cigarettes

das Päckchen Zigaretten
pack of cigarettes

die
Briefmarken
stamps



die Postkarte
postcard



das Comicheft
comic



die Zeitschrift
magazine



die Zeitung
newspaper

das Rauchen • smoking



der Tabak
tobacco



das Feuerzeug
lighter



der Kopf
bowl

der Stiel
stem

die Pfeife
pipe



die Zigarre
cigar

der Konditor • confectionery

die Schachtel Pralinen
box of chocolates

die
Nascherei
snack bar

die Chips
chips



das Süßwarengeschäft | candy store

Vokabular • vocabulary

die
Milkschokolade
milk chocolate

die bittere
Schokolade
semisweet
chocolate

die weiße
Schokolade
white chocolate

die bunte
Mischung
pick-and-mix

der Karamell
caramel

der Trüffel
truffle

der Keks
cookie

die Bonbons
hard candy

die Süßwaren • confectionery



die Praline
chocolate



die Tafel Schokolade
chocolate bar



die Bonbons
candy



der Lutscher
lollipop



das Toffee
toffee



der Nugat
nougat



das Marshmallow
marshmallow



das Pfefferminz
mint



der Kaugummi
chewing gum



der Geleebonbon
jellybean



der Fruchtgummi
gumdrop



die Lakritze
licorice

andere Geschäfte • other stores



die Bäckerei
bread shop



die Konditorei
bakery



die Metzgerei
butcher shop



das Fischgeschäft
fish counter



der Gemüseladen
produce stand



das Lebensmittelgeschäft
grocery store



das Schuhgeschäft
shoe store



die Eisenwarenhandlung
hardware store



der Antiquitätenladen
antique shop



der Geschenkartikel-laden
gift shop



das Reisebüro
travel agency



das Juweliergeschäft
jewelry store



der Buchladen
bookstore



das Plattengeschäft
record store



die Weinhandlung
liquor store



die Tierhandlung
pet store



das Möbelgeschäft
furniture store



die Boutique
boutique

Vokabular • vocabulary

das Gartencenter
garden center

das Fotogeschäft
camera store

die Reinigung
dry-cleaner

das Reformhaus
health-food store

der Waschsalon
laundromat

die Kunsthandlung
art store

der Immobilienmakler
real estate office

der Gebrauchtwarenhändler
second-hand store



die Schneiderei
tailor shop



der Frisiersalon
beauty salon



der Markt | market





die Nahrungsmittel
food

das Fleisch • meat



Vokabular • vocabulary

das Rindfleisch
beef

das Wild
venison

die Zunge
tongue

aus Freilandhaltung
free-range

das rote Fleisch
red meat

das Kalbfleisch
veal

das Kaninchen
rabbit

gepökelt
cured

biologisch kontrolliert
organic

das magere Fleisch
lean meat

das Schweinefleisch
pork

die Innereien
offal

geräuchert
smoked

das weiße Fleisch
white meat

das gekochte Fleisch
cooked meat

die Fleischsorten • cuts

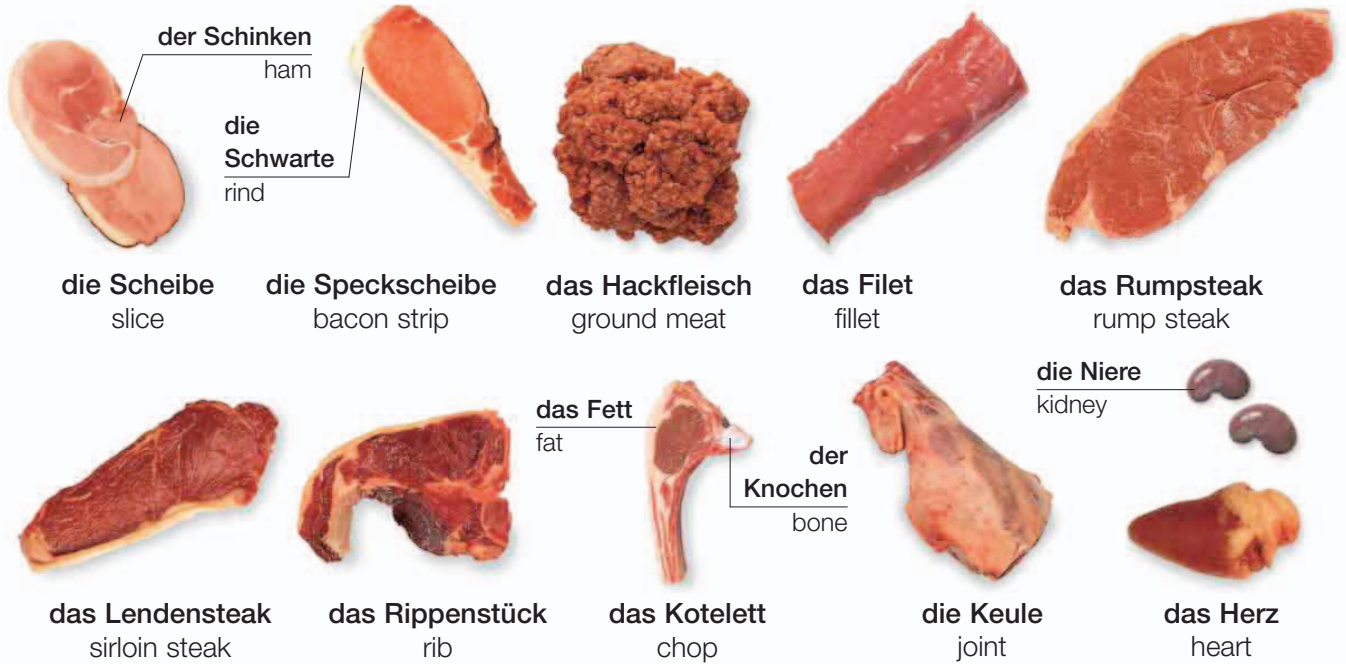

das Geflügel • poultry

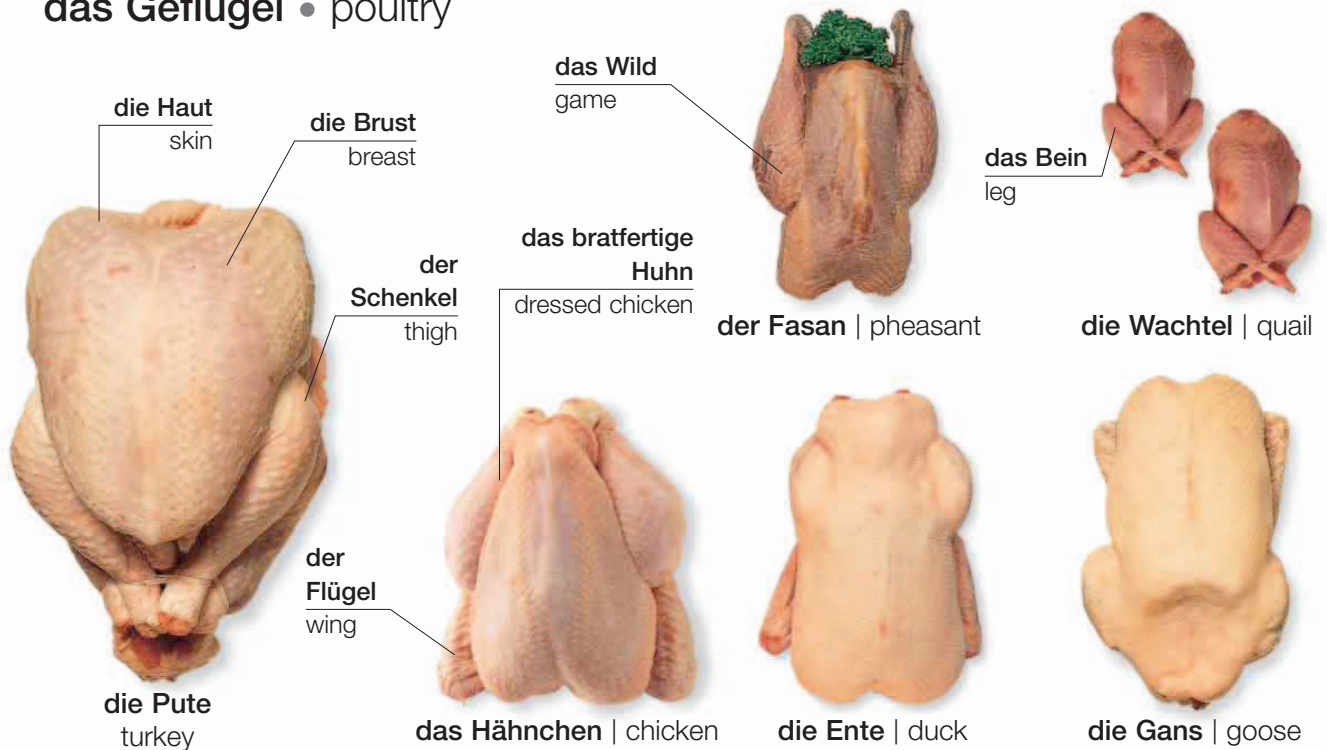

der Fisch • fish

die geschälten
Garnelen

peeled shrimp

das Eis
ice

die rote
Meeräsche
red mullet

die Heilbuttfillets
halibut fillets

die
Regenbogenforelle
rainbow trout

die
Rochenflügel
skate wings

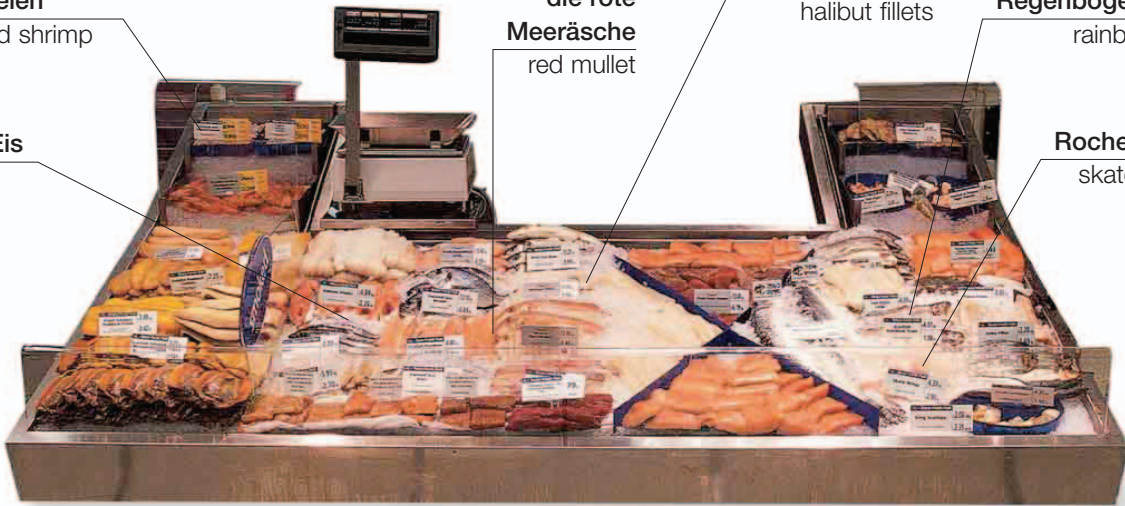

das Fischgeschäft
fish counter



die Quappe
monkfish



die Makrele
mackerel



die Forelle
trout



der Schwertfisch
swordfish



die Seezunge
Dover sole



die Rotzunge
lemon sole



der Schellfisch
haddock



die Sardine
sardine



der Rochen
skate



der Weißfisch
whiting



der Seebarsch
sea bass



der Lachs | salmon



der Kabeljau
cod



der Seebrassen
sea bream



der Tunfisch
tuna

die Meeresfrüchte • seafood

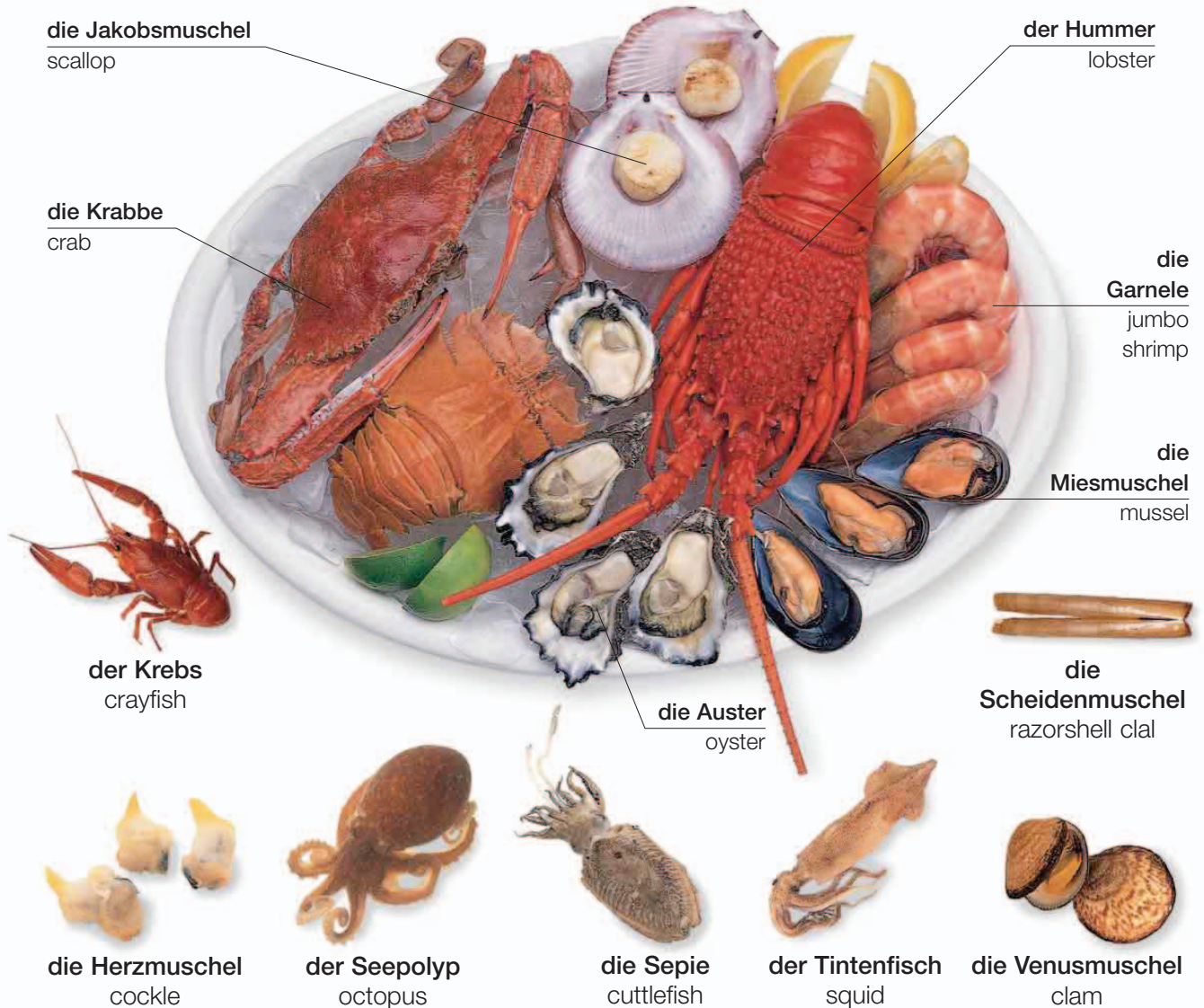

Vokabular • vocabulary

tiefgefroren frozen	gesalzen salted	zubereitet cleaned	entschuppt descaled	enthäutet skinned	die Lende loin	die Gräte bone	das Filet fillet
frisch fresh	geräuchert smoked	filetiert filleted	entgrätet boned	die Schuppe scale	der Schwanz tail	die Schmitte steak	

das Gemüse 1 • vegetables 1

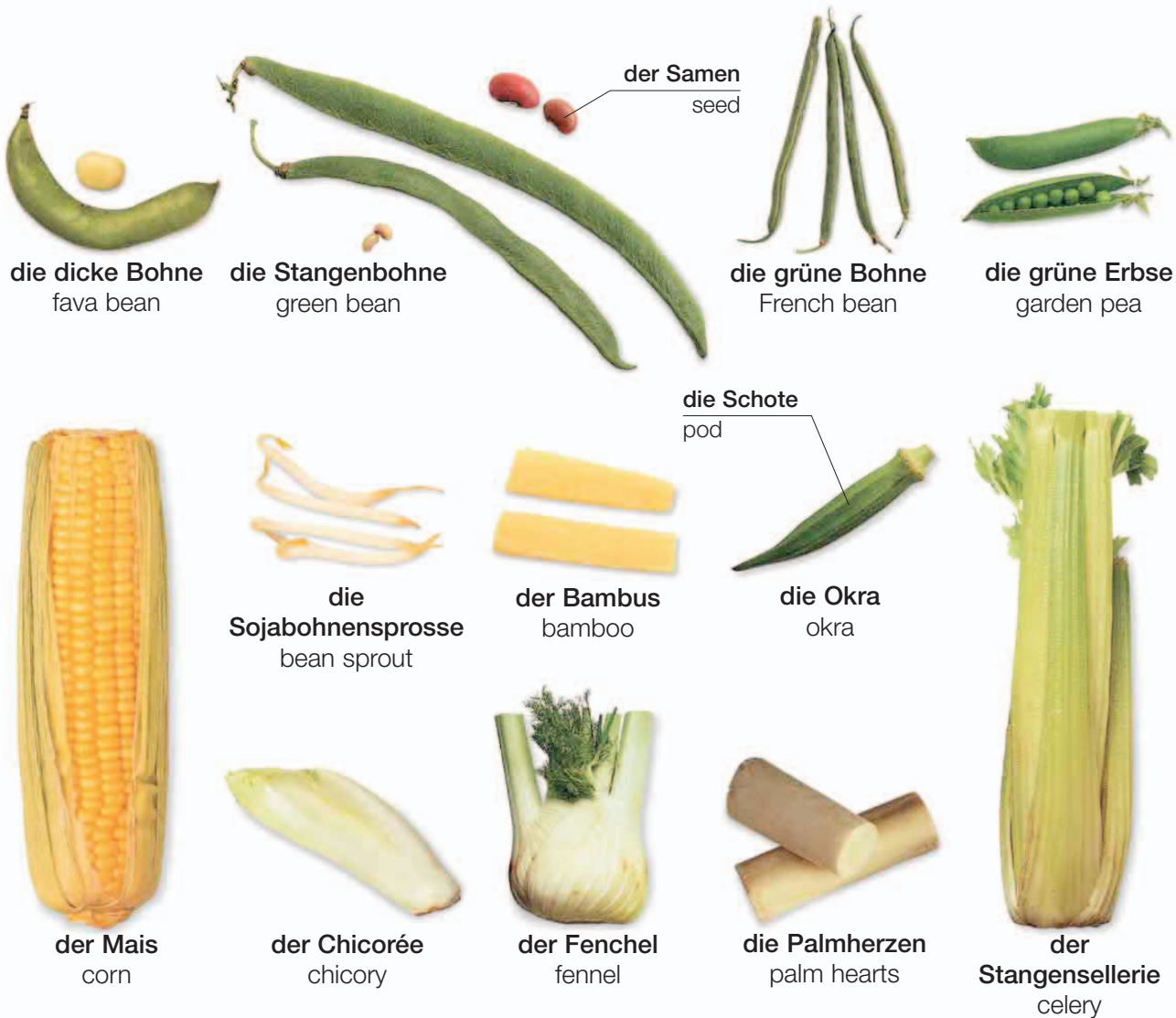

Vokabular • vocabulary

das Blatt
leaf

das Röschen
floret

die Spitze
tip

biodynamisch
organic

Verkaufen Sie Biogemüse?
Do you sell organic vegetables?

der Strunk
stalk

der Kern
kernel

das Herz
heart

die Plastiktüte
plastic bag

Werden sie in dieser Gegend
angebaut?
Are these grown locally?



die Rauke
arugula



die Brunnenkresse
watercress



der Radicchio
radicchio



der Rosenkohl
Brussels sprout



der Mangold
Swiss chard



der Grünkohl
kale



der Garten-Sauerampfer
sorrel



die Endivie
endive



der Löwenzahn
dandelion



der Spinat
spinach



der Kohlrabi
kohlrabi



der Chinakohl
pak-choi



der Salat
lettuce



der Brokkoli
broccoli



der Kohl
cabbage



der Frühl Kohl
spring greens

das Gemüse 2 • vegetables 2

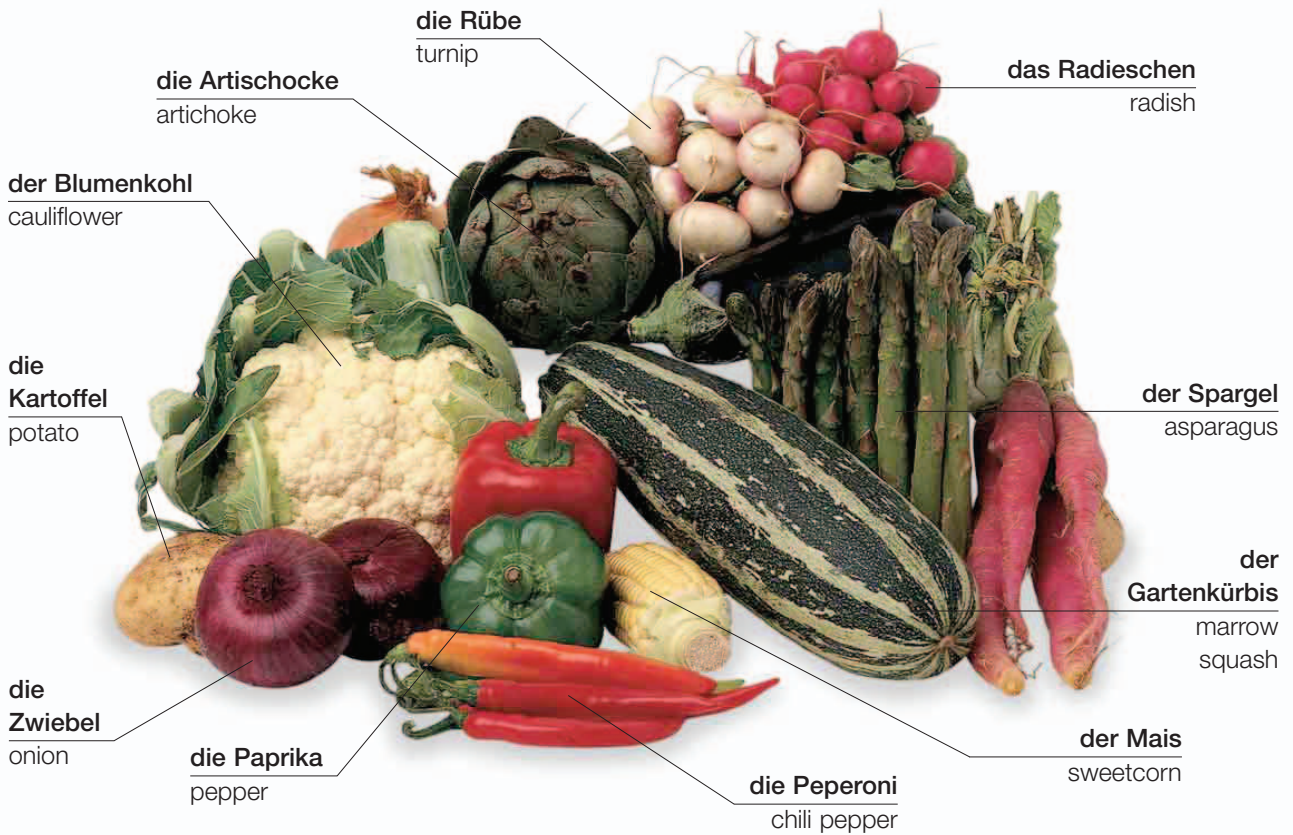

Vokabular • vocabulary

die Kirschtomate
cherry tomato

der Sellerie
celeriac

tiefgefroren
frozen

bitter
bitter

die Karotte
carrot

die Tarowurzel
taro root

roh
raw

fest
firm

die Brotfrucht
breadfruit

der Maniok
cassava

scharf
hot (spicy)

das Fleisch
flesh

die neue Kartoffel
new potato

die Wasserkastanie
water chestnut

süß
sweet

die Wurzel
root

Könnte ich bitte ein Kilo Kartoffeln haben?

Can I have one kilo of potatoes, please?

Was kostet ein Kilo?

What's the price per kilo?

Wie heißen diese?

What are those called?



die Süßkartoffel
sweet potato



die Jamswurzel
yam



die Rote Bete
beet



die Kohlrübe
rutabaga

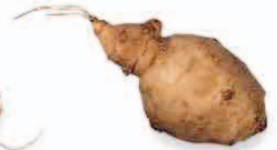

der Topinambur
Jerusalem
artichoke



der Meerrettich
horseradish



die Pastinake
parsnip



der Ingwer
ginger



die Aubergine
eggplant



die Tomate
tomato



die
Frühlingszwiebel
green onion



der Lauch
leek



die Schalotte
shallot



der Knoblauch
garlic

die Zehe
clove



der Pilz
mushroom

die Trüffel
truffle



die Gurke
cucumber



die Zucchini
zucchini



der Butternusskürbis
butternut squash



der Eichelkürbis
acorn squash



der Kürbis
pumpkin

das Obst 1 • fruit 1

die Zitrusfrüchte • citrus fruit



die Orange
orange



die Klementine
clementine

die weiße
Haut
pith

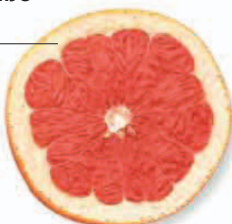

die Grapefruit
grapefruit



die Tangelo
ugli fruit



die Mandarine
tangerine

der Schnitz
segment



die Satsuma
satsuma



die Limone
lime

die Schale
zest



die Zitrone
lemon



die Kumquat
kumquat

das Steinobst • stone fruit



der Pfirsich
peach



die Nektarine
nectarine



die Aprikose
apricot



die Pflaume
plum



die Kirsche
cherry

die Birne
pear

der Apfel
apple



der Obstkorb | basket of fruit

das Beerenobst und die Melonen • berries and melons



die Erdbeere
strawberry



die Himbeere
raspberry



die Melone
melon



die Weintrauben
grapes



die Brombeere
blackberry



die Johannisbeere
red currant



die Preiselbeere
cranberry



die schwarze
Johannisbeere
black currant



die Heidelbeere
blueberry



die weiße Johannisbeere
white currant



die Loganbeere
loganberry



die Stachelbeere
gooseberry

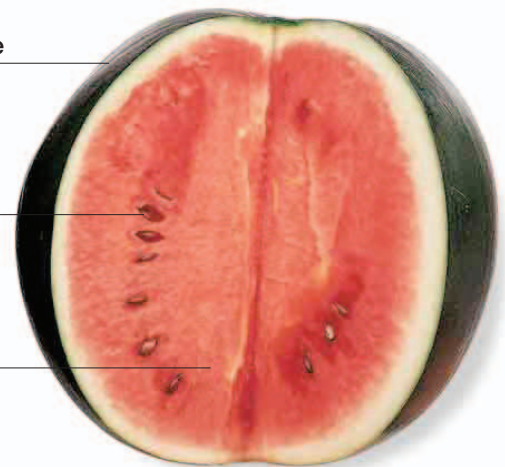

die Schale
rind

der Kern
seed

das
Fruchtfleisch
flesh

die Wassermelone
watermelon

Vokabular • vocabulary

saftig
juicy

sauer
sour

knackig
crisp

kernlos
seedless

Sind sie reif?
Are they ripe?

die Faser
fiber

frisch
fresh

faul
rotten

der Saft
juice

Könnte ich eine
probieren?
Can I try one?

süß
sweet

der
Rhabarber
rhubarb

das
Fruchtmarm
pulp

das
Kerngehäuse
core

Wie lange halten
sie sich?
How long will they
keep?

das Obst 2 • fruit 2

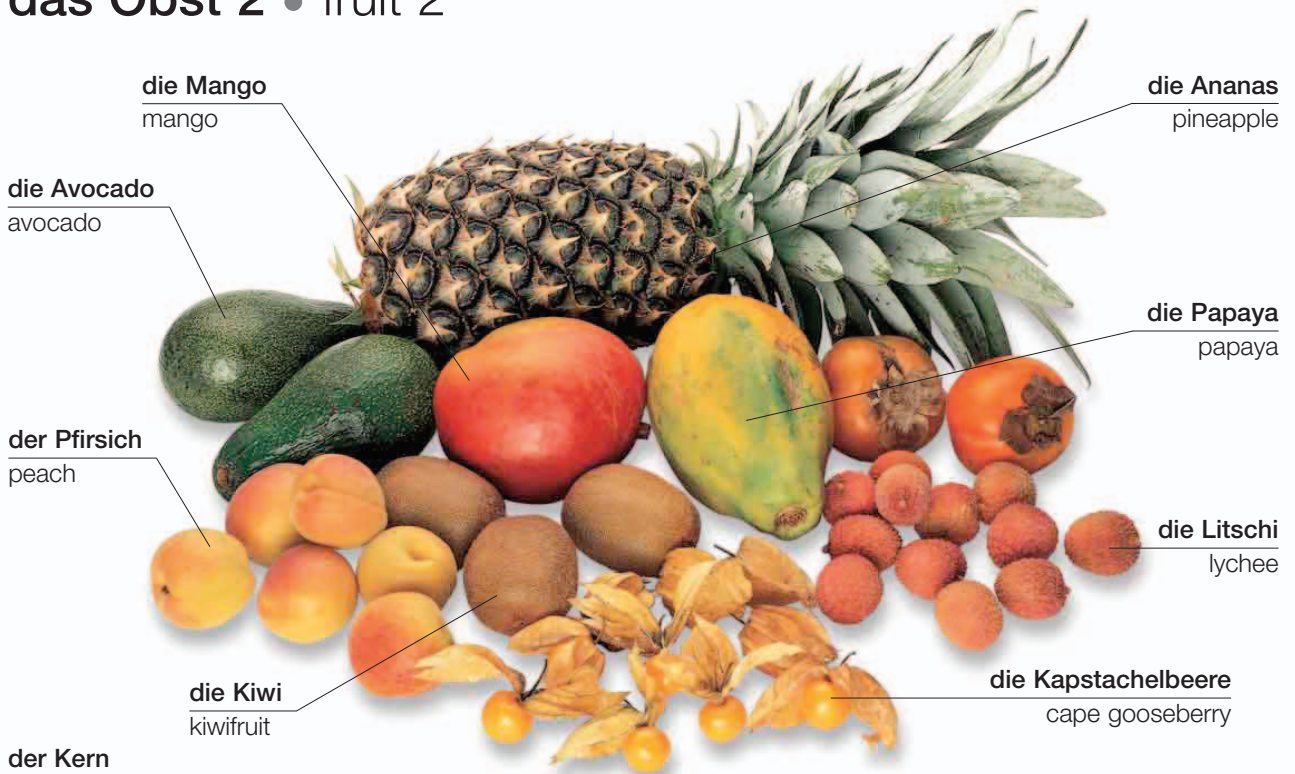

der Kern
seed



die Quitte
quince



die Passionsfrucht
passion fruit

die Schale
skin



die Banane
banana



die Guave
guava



der Granatapfel
pomegranate



die Kaki
persimmon



die Feijoa
feijoa



die Kaktusfeige
prickly pear



die Sternfrucht
starfruit



die Tamarillo
tamarillo

die Nüsse und das Dörrobst • nuts and dried fruit



die Piniennuss
pine nut



die Pistazie
pistachio



die Cashewnuss
cashew



die Erdnuss
peanut



die Haselnuss
hazelnut



die Paranuss
Brazil nut



die Pecannuss
pecan



die Mandel
almond



die Walnuss
walnut



die Esskastanie
chestnut



die Macadamianuss
macadamia



die Feige
fig



die Dattel
date



die Backpflaume
prune

die Schale
shell



die Sultanine
sultana raisin



die Rosine
raisin



die Korinthe
currant

das
Fruchtfleisch
flesh



die Kokosnuss
coconut

Vokabular • vocabulary

grün green	hart hard	der Kern kernel	gesalzen salted	geröstet roasted	die Südfrüchte tropical fruit	geschält shelled
reif ripe	weich soft	getrocknet desiccated	roh raw	Saison- seasonal	die kandierten Früchte candied fruit	ganz whole

die Getreidearten und die Hülsenfrüchte •

grains and legumes

das Getreide • grains



der Weizen
wheat



der Hafer
oats



die Gerste
barley

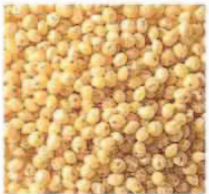

die Hirse
millet



der Mais
corn

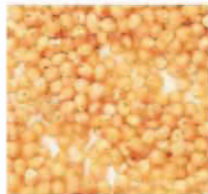

die Reismelde
quinoa

Vokabular • vocabulary

trocken dry	frisch fresh	Vollkorn whole-grain
die Hülse husk	aromatisch fragranced	Langkorn long-grain
der Kern kernel	einweichen soak (v)	Rundkorn short-grain
der Samen seed	die Getreideflocken cereal	leicht zu kochen easy-cook

der Reis • rice



der weiße Reis
white rice



der Naturreis
brown rice



der Wasserreis
wild rice



der Milchreis
pudding rice

die verarbeiteten Getreidearten • processed grains



der Kuskus
couscous



der Weizenschrot
cracked wheat



der Grieß
semolina



die Kleie
bran

die Bohnen und die Erbsen • beans and peas



die **Mondbohnen**
butter beans



die **weißen Bohnen**
haricot beans



die **roten Bohnen**
red kidney beans



die **Adzuki-Bohnen**
aduki beans



die **Saubohnen**
fava beans



die **Sojabohnen**
soybeans



die **Teparybohnen**
black-eyed beans



die **Pintobohnen**
pinto beans



die **Mungbohnen**
mung beans



die **französischen Bohnen**
flageolet beans



die **braunen Linsen**
brown lentils



die **roten Linsen**
red lentils



die **grünen Erbsen**
green peas



die **Kichererbsen**
garbanzos



die **getrockneten Erbsen**
split peas

die Körner • seeds



der **Kürbiskern**
pumpkin seed



das **Senfkorn**
mustard seed



der **Kümmel**
caraway



das **Sesamkorn**
sesame seed



der **Sonnenblumenkern**
sunflower seed

die Kräuter und Gewürze • herbs and spices

die Gewürze • spices



die Vanille
vanilla



die Muskatnuss
nutmeg



die Muskatblüte
mace



die Kurkuma
turmeric



der Kreuzkümmel
cumin



die
Kräutermischung
bouquet garni



der Piment
allspice

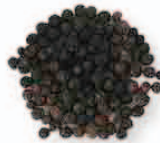

das Pfefferkorn
peppercorn



der
Bockshornklee
fenugreek



der Chili
chili powder

ganz
whole

zerstoßen
crushed



der Safran
saffron



der Kardamom
cardamom



das Currypulver
curry powder

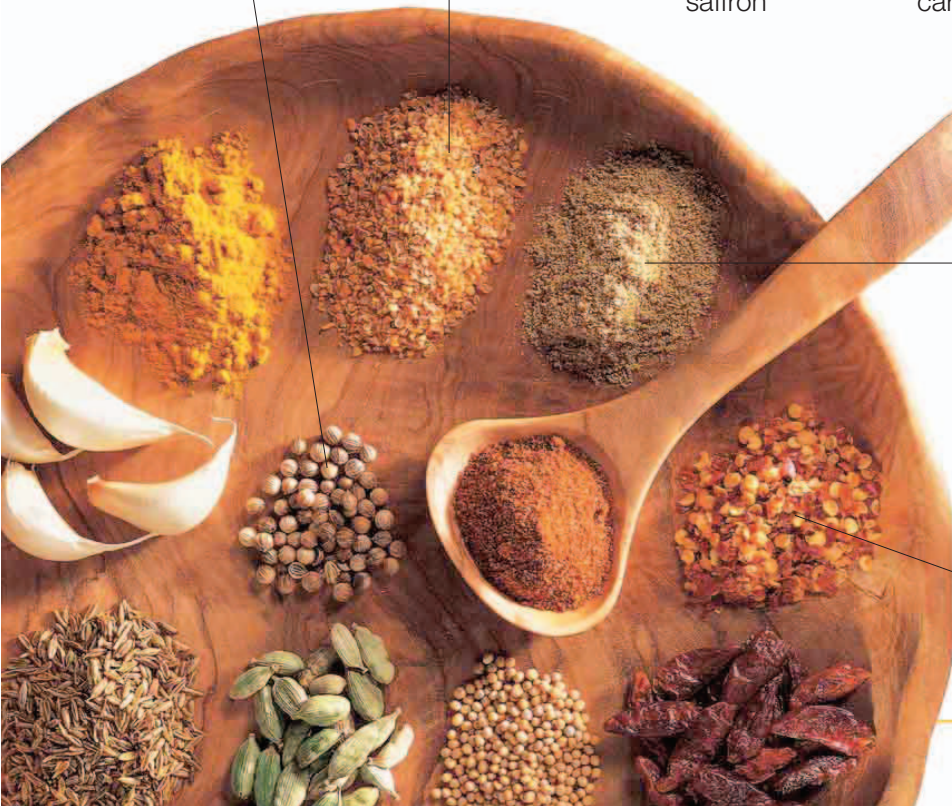

gemahlen
ground



der Paprika
paprika

geraspelt
flakes



der Knoblauch
garlic

die Kräuter • herbs

die Stangen
sticks



der Zimt
cinnamon



das
Zitronengras
lemon grass



die Gewürznelke
cloves



der Sternanis
star anise



der Ingwer
ginger

die
Fenchelsamen
fennel seeds



der Fenchel
fennel



der Schnittlauch
chives



die Minze
mint



das Lorbeerblatt
bay leaf



die Petersilie
parsley



der Salbei
sage



der Estragon
tarragon



der Majoran
marjoram



das Basilikum
basil



der Oregano
oregano



der Koriander
cilantro



der Dill
dill



der Rosmarin
rosemary

die Nahrungsmittel in Flaschen • bottled foods



der süße Aufstrich • sweet spreads



die Würzen • condiments and spreads



Vokabular • vocabulary

das Pflanzenöl das Rapsöl
vegetable oil canola oil

das Maiskeimöl das kaltgepresste Öl
corn oil cold-pressed oil

das Erdnussöl
peanut oil

die Milchprodukte • dairy produce

der Käse • cheese

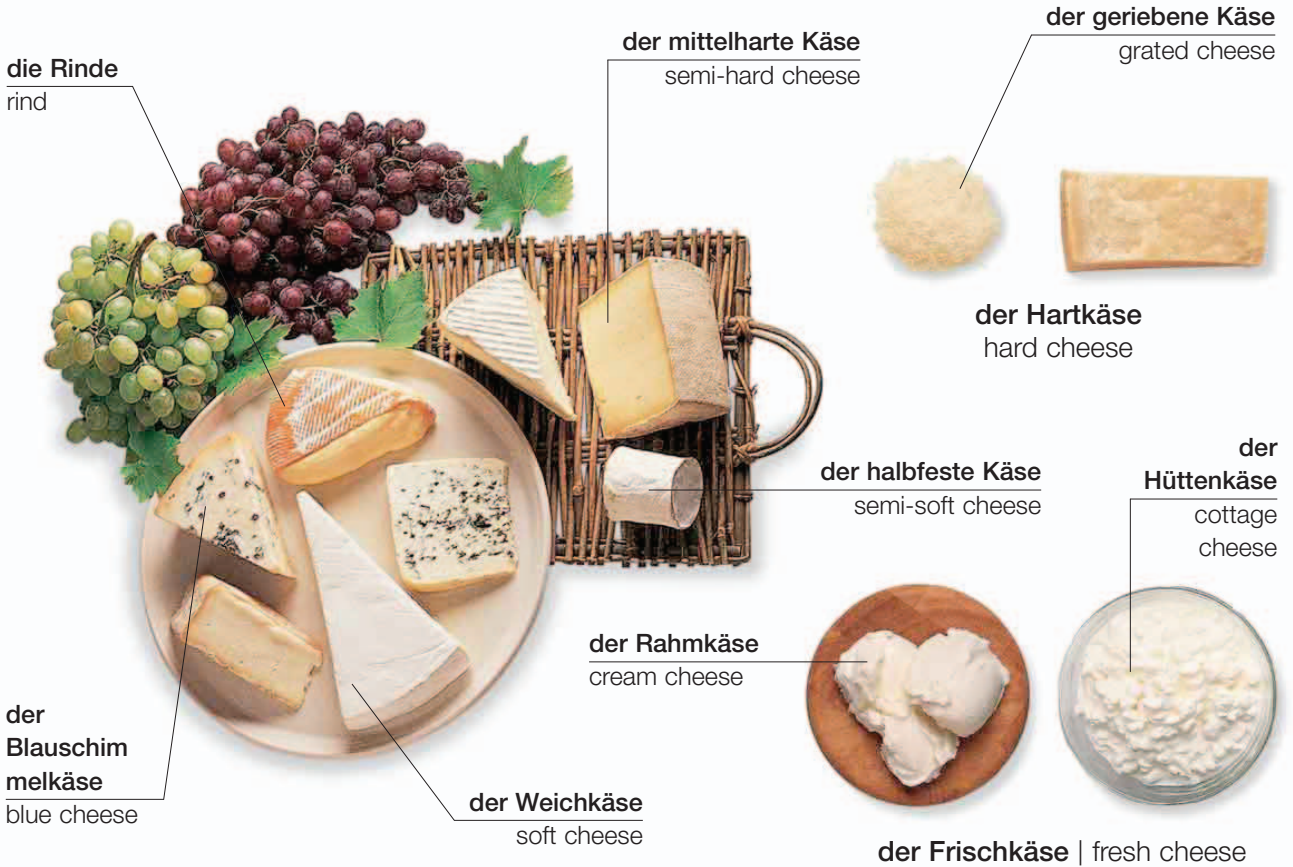

die Milch • milk





die Butter
butter



die Margarine
margarine



die Sahne
cream



die fettarme Sahne
light cream



die Schlagsahne
heavy cream



die Schlagsahne
whipped cream



die saure Sahne
sour cream



der Joghurt
yogurt



das Eis
ice cream

die Eier • eggs

das Eigelb
yolk

das Eiweiß
egg white

die Eierschale
shell

**der Eier
becher**
egg cup



das gekochte Ei
boiled egg



das Gänseei
goose egg



das Hühnerei
hen's egg



das Entenei
duck egg



das Wachtelei
quail egg

Vokabular • vocabulary

pasteurisiert
pasteurized

fettfrei
fat-free

gesalzen
salted

die Schafmilch
sheep's milk

die Laktose
lactose

der Milchshake
milkshake

unpasteurisiert
unpasteurized

**das
Milchpulver**
powdered milk

ungesalzen
unsalted

die Buttermilch
buttermilk

homogenisiert
homogenized

**der gefrorene
Joghurt**
frozen yogurt

das Brot und das Mehl • breads and flours



die Bäckerei | bakery

Brot backen • making bread



das Weizenmehl
white flour



das Roggenmehl
brown flour



das Vollkornmehl
whole-wheat flour



die Hefe
yeast



sieben | sift (v)



verrühren | mix (v)

der Teig
dough



backen | bake (v)



die Kruste
crust

das Weißbrot
white bread



der Laib
loaf

das Graubrot
brown bread



das Vollkornbrot
whole-wheat bread

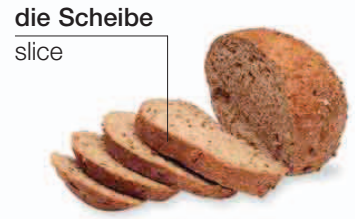

die Scheibe
slice

das Mehrkornbrot
multigrain bread



das Maisbrot
cornbread



das Sodabrot
soda bread



das Sauerteigbrot
sourdough bread



das Fladenbrot
flatbread



das Hefebrötchen
bagel



das weiche Brötchen
bun



das Brötchen
roll



das Rosinenbrot
fruit bread



das Körnerbrot
seeded bread



der Naan
naan bread



das Pitabrot
pita bread

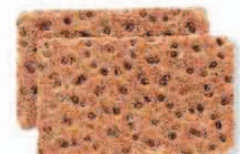

das Knäckebrot
crispbread

Vokabular • vocabulary

das angereicherte Mehl
bread flour

das Paniermehl
breadcrumbs

gehen lassen
prove (v)

aufgehen
rise (v)

der Brotschneider
slicer

das Mehl mit
Backpulver
self-rising flour

das Mehl ohne
Backpulver
all-purpose flour

glasieren
glaze (v)

die Flöte
flute

der Bäcker
baker

Kuchen und Nachspeisen • cakes and desserts



das Eclair
éclair

der Brandteig
choux pastry

die Sahne
cream

der Blätterteig
puff pastry

die Füllung
filling

der Blätterteig
phyllo pastry

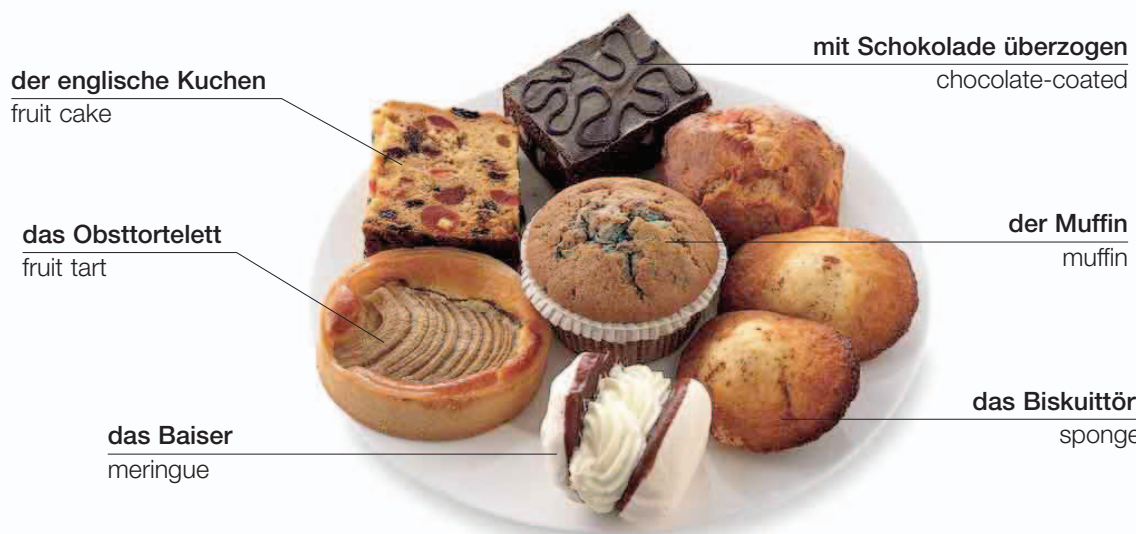

der englische Kuchen
fruit cake

mit Schokolade überzogen
chocolate-coated

das Obsttortelett
fruit tart

der Muffin
muffin

das Baiser
meringue

das Biskuitörtchen
sponge cake

das Gebäck | cakes

Vokabular • vocabulary

die Konditorcreme
crème patisserie

das Teilchen
bun

der Teig
pastry

der Milchreis
rice pudding

Könnte ich bitte ein Stück haben?

die Schokoladentorte
chocolate cake

der Vanillepudding
custard

das Stück
slice

die Feier
celebration

May I have a slice, please?

das Schokoladenstückchen
chocolate chip



die Löffelbiskuits
lady fingers



das Trifle
trifle

der Florentiner
florentine

die Kekse | cookies



die Mousse
mousse



das Sorbett
sherbet



die Sahnetorte
cream pie



der Karamellpudding
crème caramel

die festlichen Kuchen • celebration cakes

der obere Kuchenteil
top tier

das Band
ribbon

der untere Kuchenteil
bottom tier

der Zuckerguss
icing

das Marzipan
marzipan



die Hochzeitstorte | wedding cake

die Dekoration
decoration

die Geburtstagskerzen
birthday candles

ausblasen
blow out (v)



der Geburtstagskuchen | birthday cake

die Feinkost • delicatessen

die pikante
Wurst
spicy sausage

das Öl
oil



die Salami
salami

die
Pepperoniwurst
pepperoni

der Essig
vinegar

das frische Fleisch
uncooked meat

die Theke
counter

die Quiche
quiche



die Pastete
pâté



der Mozzarella
mozzarella



der Brie
brie



der Ziegenkäse
goat's cheese



der Cheddar
cheddar



der Parmesan
parmesan



der Camembert
camembert

die Rinde
rind



der Edamer
edam



der Manchego
manchego

die Pasteten
meat pies

die schwarze Olive
black olive

die Peperoni
chili pepper

die Soße
sauce

das Brötchen
bread roll

**das gekochte
Fleisch**
cooked meat

die grüne Olive
green olive

der Schinken
ham

die Sandwichtheke
sandwich counter



der Räucherfisch
smoked fish



die Kapern
capers



der Prosciutto
prosciutto

die Chorizo
chorizo



die gefüllte Olive
stuffed olive

Vokabular • vocabulary

in Öl
in oil

mariniert
marinated

geräuchert
smoked

in Lake
in brine

gepökelt
salted

getrocknet
cured

Nehmen Sie bitte eine Nummer.

Take a number, please.

Kann ich bitte etwas davon probieren?

Can I try some of that, please?

Ich hätte gerne sechs Scheiben davon, bitte.

May I have six slices of that, please?

die Getränke • drinks

das Wasser • water



die heißen Getränke • hot drinks



die alkoholfreien Getränke • soft drinks



die alkoholischen Getränke • alcoholic drinks



der Gin
gin



das Bier
beer

die Dose
can



der Apfelwein
cider



das halbdunkle
Bier
bitter



der Stout
stout



der Wodka
vodka



der Whisky
whiskey



der Rum
rum



der Weinbrand
brandy



der Portwein
port



der Sherry
sherry

trocken
dry



der Campari
campari

rosé
rosé

weiß
white

rot
red



der Likör
liqueur



der Tequila
tequila



der Champagner
champagne



der Wein
wine





auswärts essen
eating out

das Café • café



die Speisekarte
menu

die Markise
awning

das Straßencafé | sidewalk café



der Sonnenschirm
umbrella

das Terrassencafé
terrace café

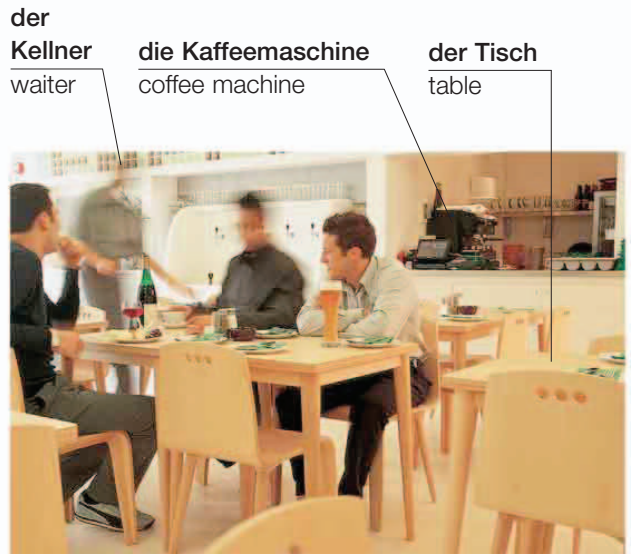

der Kellner
waiter

die Kaffeemaschine
coffee machine

der Tisch
table

die Snackbar | snack bar

der Kaffee • coffee



der Kaffee mit Milch
coffee with milk

der Filterkaffee
filter coffee



der schwarze Kaffee
black coffee

der Espresso
espresso



das Kakaopulver
cocoa powder

der Cappuccino
cappuccino

der Schaum
froth



der Eiskaffee
iced coffee

der Tee • tea

der Kräutertee
herbal tea



der Tee mit Milch
tea with milk

der schwarze Tee
black tea



der Kamillentee
chamomile tea



der grüne Tee
green tea



der Tee mit Zitrone
tea with lemon



der Pfefferminztee
mint tea



der Eistee
iced tea

die Säfte und Milchshakes • juices and milkshakes



der Orangensaft
orange juice



der Apfelsaft
apple juice



der Ananassaft
pineapple juice



der Tomatensaft
tomato juice

der Schokoladenmilchshake
chocolate milkshake

der Erdbeermilchshake
strawberry milkshake

der Kaffeemilchshake
coffee milkshake



das Essen • food

das Graubrot
whole-wheat bread

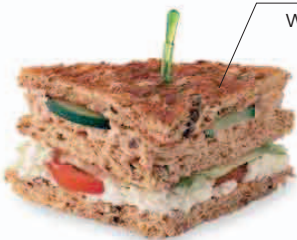

der getoastete Sandwich
toasted sandwich



der Salat
salad



die Kugel
scoop

das Eis
ice cream



das Gebäck
pastry

die Bar • bar



die Gläser
glasses

das Maß
optic

die Kasse
cash register

der Barkeeper
bartender

der Zapfhahn
beer tap

die Kaffeemaschine
coffee machine

der Eiskübel
ice bucket

der Barhocker
bar stool

der Aschbecher
ashtray

der Untersetzer
coaster

die Theke
bar counter

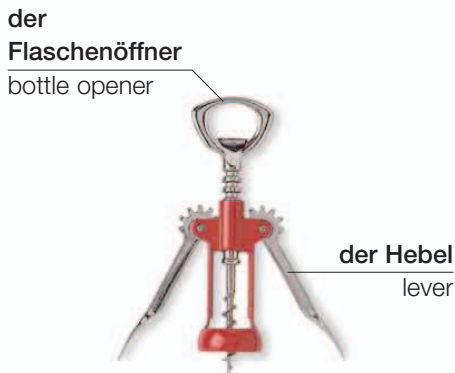

der Flaschenöffner
bottle opener

der Hebel
lever

der Korkenzieher | corkscrew

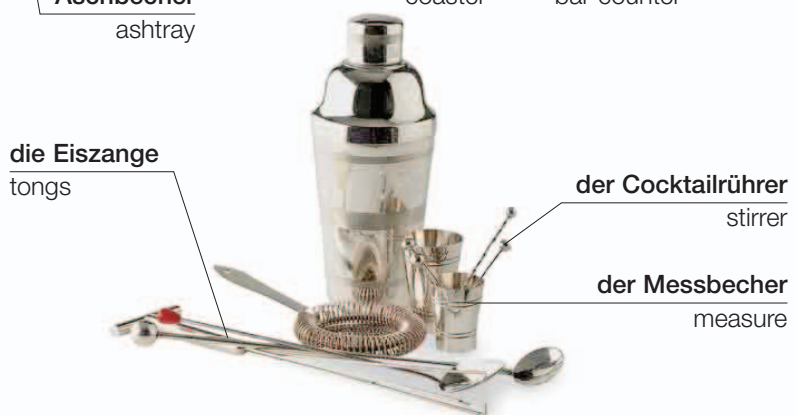

die Eiszange
tongs

der Cocktailrührer
stirrer

der Messbecher
measure

der Cocktailshaker | cocktail shaker



der Gin Tonic
gin and tonic

der Krug
pitcher



der Scotch mit Wasser
scotch and water



der Eiswürfel
ice cube

der Rum mit Cola
rum and cola



der Wodka mit Orangensaft
screwdriver



der Martini
martini



der Cocktail
cocktail



der Wein
wine



das Bier | beer



ein Schuss
shot

einfach
single



das Maß
measure



doppelt
double



ohne Eis
without ice

Eis und Zitrone
ice and lemon



mit Eis
with ice



die Knabberereien • bar snacks



die Kartoffelchips | chips

die Cashewnüsse
cashews

die Mandeln
almonds



die Nüsse | nuts

die Erdnüsse
peanuts



die Oliven | olives

das Restaurant • restaurant



das Gedeck
table setting

der
Hilfskoch
commis chef

der Küchenchef
chef

das Glas
glass

das Tablett
tray

die Küche
kitchen

der Kellner
waiter

Vokabular • vocabulary

das Abendmenü
evening menu

die Spezialitäten
specials

der Preis
price

das Trinkgeld
tip

das Buffet
buffet

der Kunde
customer

die Weinkarte
wine list

à la carte
à la carte

die Quittung
receipt

ohne Bedienung
service not included

die Bar
bar

der
Pfeffer
pepper

das
Mittagsmenü
lunch menu

der
Dessertwagen
dessert cart

die
Rechnung
check

Bedienung
inbegriffen
service included

das Salz
salt



die Speisekarte
menu



die Kinderportion
child's meal



bestellen
order (v)



bezahlen
pay (v)

die Gänge • courses



der Aperitif
apéritif



die Vorspeise
appetizer



die Suppe
soup



das Hauptgericht
entrée



die Beilage
side order



der Nachtisch | dessert



der Kaffee | coffee

Ein Tisch für zwei Personen bitte.

A table for two, please.

Könnte ich bitte die Speisekarte/Weinliste sehen?

Can I see the menu/winelist, please?

Gibt es ein Festpreismenü?

Is there a fixed-price menu?

Haben Sie vegetarische Gerichte?

Do you have any vegetarian dishes?

Könnte ich die Rechnung/Quittung haben?

Could I have the check/a receipt, please?

Könnten wir getrennt zahlen?

Can we pay separately?

Wo sind die Toiletten bitte ?

Where are the restrooms, please?

der Schnellimbiss • fast food

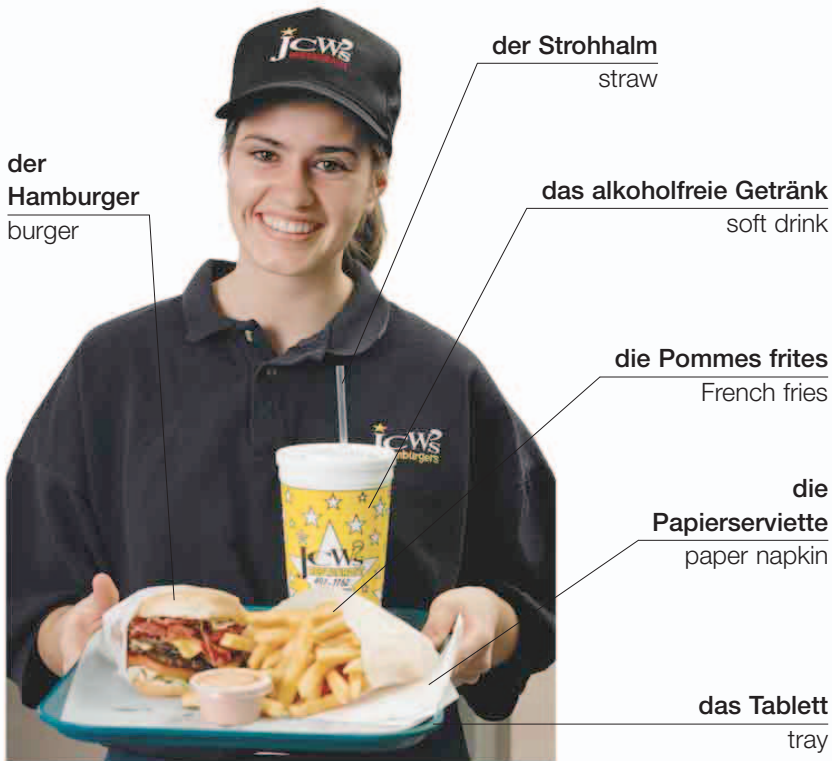

der
Hamburger
burger

der Strohhalm
straw

das alkoholfreie Getränk
soft drink

die Pommes frites
French fries

die
Papierserviette
paper napkin

das Tablett
tray

der Hamburger mit Pommes frites
burger meal

die Pizza
pizza

die Preisliste
price list

das Dosengetränk
canned drink



die Lieferung ins Haus
home delivery



der Imbissstand
street vendor

Vokabular • vocabulary

die Pizzeria
pizzeria

die Imbissstube
burger bar

die Speisekarte
menu

hier essen
for here

zum Mitnehmen
to go

aufwärmen
reheat (v)

der Tomatenketchup
ketchup

Ich möchte das
mitnehmen.
Can I have that to go,
please?

Liefere Sie ins Haus?
Do you deliver?



der Hamburger
hamburger



der Chickenburger
chicken burger



der vegetarische Hamburger
veggie burger

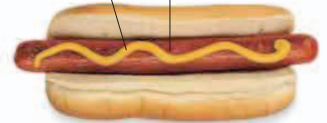

das Hot Dog
hot dog

das
Brötchen
bun

der Senf
mustard

die Wurst
sausage



der Sandwich
sandwich



der Klubsandwich
club sandwich



das belegte Brot
open-face sandwich

die Füllung
filling



das gefüllte Fladenbrot
wrap



der Kebab
kebab

die Soße
sauce



die Hähnchenstückchen
chicken nuggets

salzig
savory



die Crêpes | crêpes



süß
sweet

der Pizzabelag
topping



der Bratfisch mit Pommes
frites
fish and chips



die Rippen
ribs



das gebratene Hähnchen
fried chicken



die Pizza
pizza

das Frühstück • breakfast



die Milch
milk

die Getreide
flocken
cereal

die Konfitüre
jam

das Dörrobst
dried fruit

der Schinken
ham

der Käse
cheese

das Knäckebrot
crispbread

das Frühstücksbuffet
breakfast buffet

die Orangenmarmelade
marmalade

die Pastete
pâté

die Butter
butter

der Obstsaft
fruit juice

der Kaffee
coffee



der Frühstückstisch | breakfast table

die Schokolade
hot chocolate

das Croissant
croissant



der Tee
tea

die Getränke | drinks



die Brioche
brioche



das Brot
bread

der Toast
toast

das Spiegelei
fried egg

die Tomate
tomato

die Blutwurst
black pudding

das Würstchen
sausage

der Frühstücks speck
bacon

das englische Frühstück
English breakfast



die Räucherheringe
kippers



das in Ei gebratene Brot
French toast

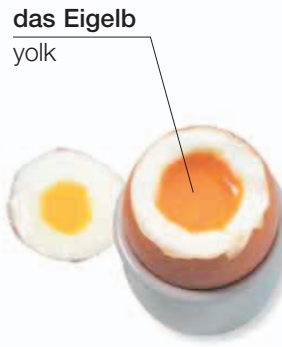

das Eigelb
yolk

das gekochte Ei
boiled egg



das Rührei
scrambled eggs



die Pfannkuchen
crêpes

die Sahne
cream

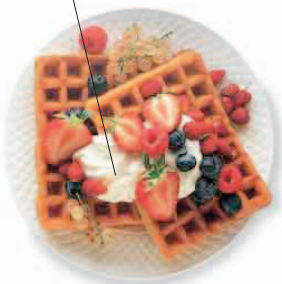

die Waffeln
waffles



der Porridge
oatmeal

der Früchtejoghurt
fruit yogurt



das Obst
fresh fruit

die Hauptmahlzeit • dinner



die Suppe | soup



die Brühe | broth



der Eintopf | stew



das Curry | curry



der Braten
roast



die Pastete
pie



das Soufflé
soufflé



der Schaschlik
kebab



die Fleischklöße
meatballs



das Omelett
omelet



das Schnellbratgericht
stir-fry



die Nudeln
noodles



die Nudeln | pasta



der Reis
rice



der gemischte Salat
tossed salad



der grüne Salat
green salad



die Salatsoße
dressing

die Zubereitung • techniques



gefüllt | stuffed



in Soße | in sauce



gegrillt | grilled



mariniert | marinated



pochiert | poached



püriert | mashed



gebacken | baked



kurzgebraten | pan-fried



gebraten
fried



ingelegt
pickled



geräuchert
smoked



frittiert
deep-fried



in Saft
in syrup



angemacht
dressed



gedämpft
steamed



getrocknet
cured





das Lernen
study

die Schule • school

die Tafel
blackboard

die Lehrerin
teacher



das Klassenzimmer | classroom

die Schultasche
schoolbag

der Schüler
student

das Pult
desk

die Kreide
chalk



das Schulmädchen | der Schuljunge
schoolgirl | schoolboy

Vokabular • vocabulary

die Literatur
literature

die Kunst
art

die Physik
physics

die Sprachen
languages

die Musik
music

die Chemie
chemistry

die Erdkunde
geography

die Mathematik
math

die Biologie
biology

die
Geschichte
history

die Naturwiss-
enschaft
science

der Sport
physical
education

die Aktivitäten • activities



lesen | read (v)



schreiben | write (v)



buchstabieren
spell (v)



zeichnen
draw (v)



der Digitalprojektor
digital projector



der Füller
pen

die Feder
nib



der Bleistift
pencil

der Buntstift
colored pencil



der Spitzer
pencil sharpener



der Radiergummi
eraser



das Heft
notebook

das Schulbuch | textbook



das Federmäppchen
pencil case



das Lineal
ruler



fragen
question (v)



antworten
answer (v)



diskutieren
discuss (v)



lernen
learn (v)

Vokabular • vocabulary

der Schulleiter
principal

die Antwort
answer

die Note
grade

die Stunde
lesson

der Aufsatz
essay

die Klasse
year

die Frage
question

die Prüfung
test

das Lexikon
encyclopedia

Notizen machen
take notes (v)

die Hausaufgabe
homework

das Wörterbuch
dictionary

die Mathematik • math

die Formen • shapes

der Kreis circle
der Mittelpunkt center
der Radius radius
der Bogen arc
der Umfang circumference
der Durchmesser diameter

das Oval oval

das Quadrat square
die Diagonale diagonal

das Rechteck rectangle

das Dreieck triangle
der Winkel angle
die Hypotenuse hypotenuse

das Parallelogramm parallelogram

der Rhombus rhombus

das Trapez trapezium

das Fünfeck pentagon

das Sechseck hexagon

das Achteck octagon

die Körper • solids

der Kegel cone
die Grundfläche base

der Zylinder cylinder

der Würfel cube
die Seite side

die Pyramide pyramid
die Spitze apex

die Kugel sphere

die Linien • lines



die Maße • measurements

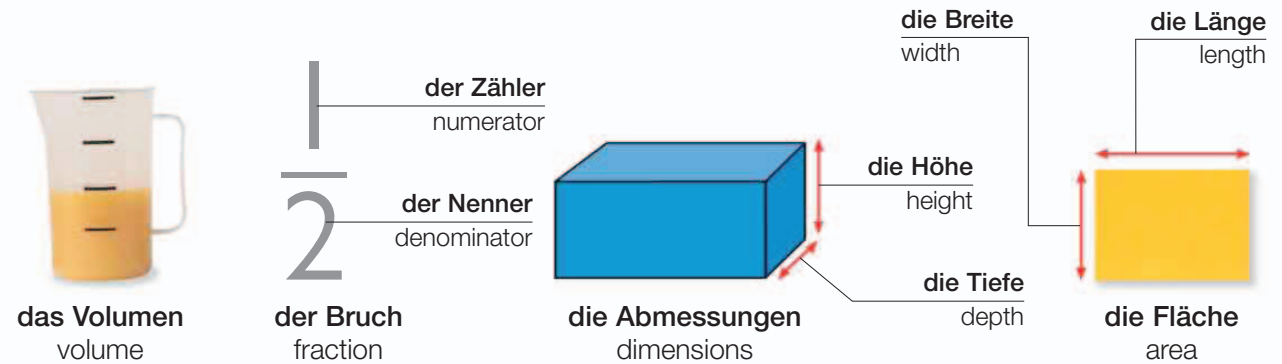

die Ausrüstung • equipment

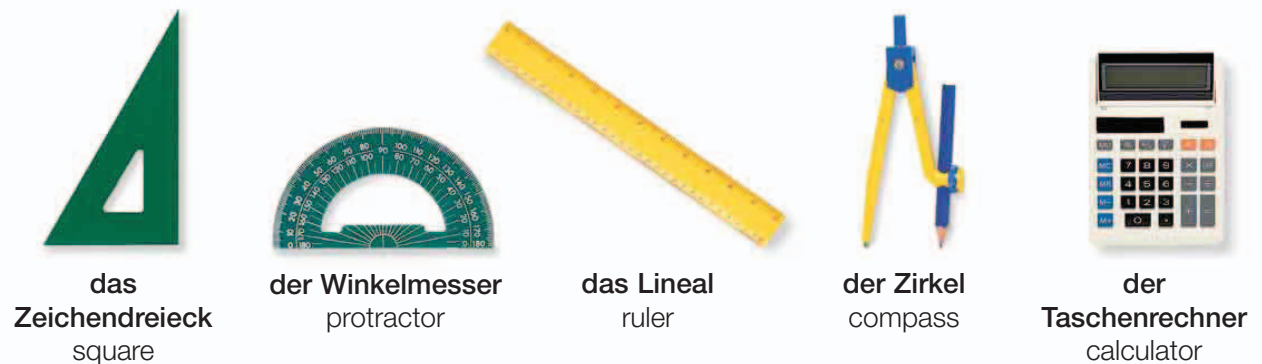

Vokabular • vocabulary

die Geometrie geometry	plus plus	mal times	gleich equals	addieren add (v)	multiplizieren multiply (v)	die Gleichung equation
die Arithmetik arithmetic	minus minus	geteilt durch divided by	zählen count (v)	subtrahieren subtract (v)	dividieren divide (v)	der Prozentsatz percentage

die Wissenschaft • science



das Labor
laboratory



die Laborwaage
scales



das Gewicht
weight

die Federwaage
spring balance

der Tiegel
crucible



der Bunsenbrenner
bunsen burner

der Dreifuß
tripod



die Glasflasche
glass bottle

der Trichter
funnel

der Kolben
flask

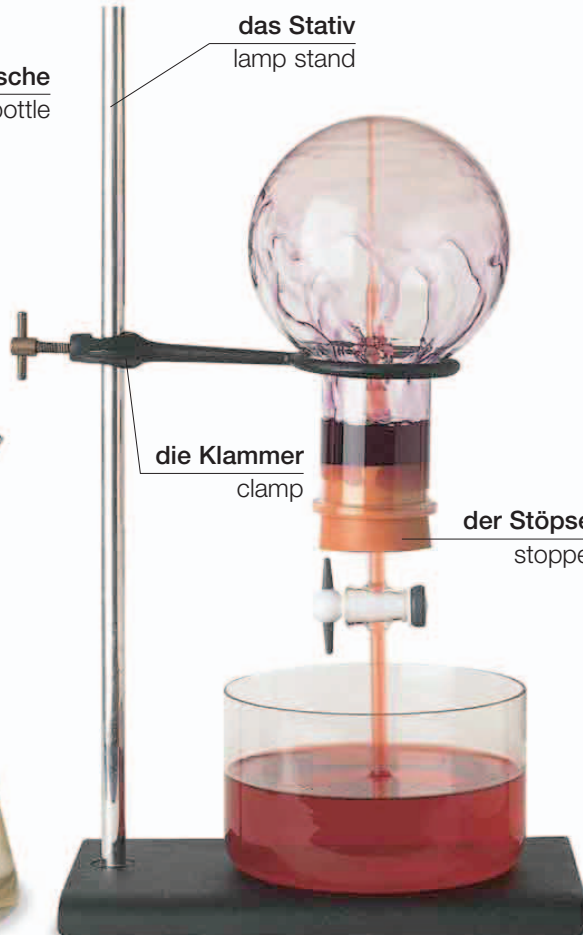

das Stativ
lamp stand

die Klammer
clamp

der Stöpsel
stopper

der Versuch | experiment

das Reagenzglas
test tube



das Gestell
rack



der Zeitmesser
timer



die Petrischale
petri dish



das Thermometer
thermometer



die Spritze
syringe



die Pinzette
tweezers



das Skalpell
scalpel



der Tropfer
dropper



die Zange | forceps



die Greifzange
tongs



der Spatel
spatula

die Keule
pestle



der Mörser
mortar



das Filterpapier
filter paper



die Schutzbrille
safety goggles

das Okular
eyepiece

der Einstellknopf
focusing knob



die Objektivlinse
objective lens

der Tisch
stage

der Objektträger
slide

der Spiegel
mirror



das Glasstäbchen
glass stirrer



das Becherglas
beaker

die Pipette
pipette



der Magnet
magnet



die Krokodilklemme
alligator clip

die negative Elektrode
negative electrode



die positive Elektrode
positive electrode

das Mikroskop | microscope

die Batterie | battery

die Hochschule • college



das Sekretariat
admissions office

die Mensa
cafeteria

die Gesundheits-
fürsorge
clinic

der
Sportplatz
sports field

das
Studenten-
heim
residence hall

der Campus | campus

Vokabular • vocabulary

der Leserausweis library card
die Auskunft helpdesk
verlängern renew (v)

der Lesesaal reading room
ausleihen borrow (v)
das Buch book

die Literaturliste reading list
vorbestellen reserve (v)
der Titel title

das Rückgabedatum due date
die Ausleihe loan
der Gang aisle

die Bibliothekarin
librarian

die Ausleihe
circulation desk

das Bücher
regal
bookshelf

das
Periodikum
periodical

die
Zeitschrift
journal



die Bibliothek | library

der Student
undergraduate

der Dozent
professor



der Hörsaal
lecture hall

die Graduierte
graduate

die Robe
gown



die Graduierungsfeier
graduation ceremony

die Fachhochschulen • schools



das Model
model

die Kunsthochschule
art college



die Musikhochschule
music school



die Tanzakademie
dance academy

Vokabular • vocabulary

das Stipendium
scholarship

die Forschung
research

die Examensarbeit
dissertation

die Medizin
medicine

die Philosophie
philosophy

postgraduiert
postgraduate

der Magister
master's

der Fachbereich
department

die Zoologie
zoology

die Politologie
politics

das Diplom
diploma

die Promotion
doctorate

der Maschinenbau
engineering

die Physik
physics

die Literatur
literature

der akademische Grad
degree

die Dissertation
thesis

die Kunstgeschichte
art history

die Rechtswissenschaft
law

die Wirtschaftswissenschaft
economics

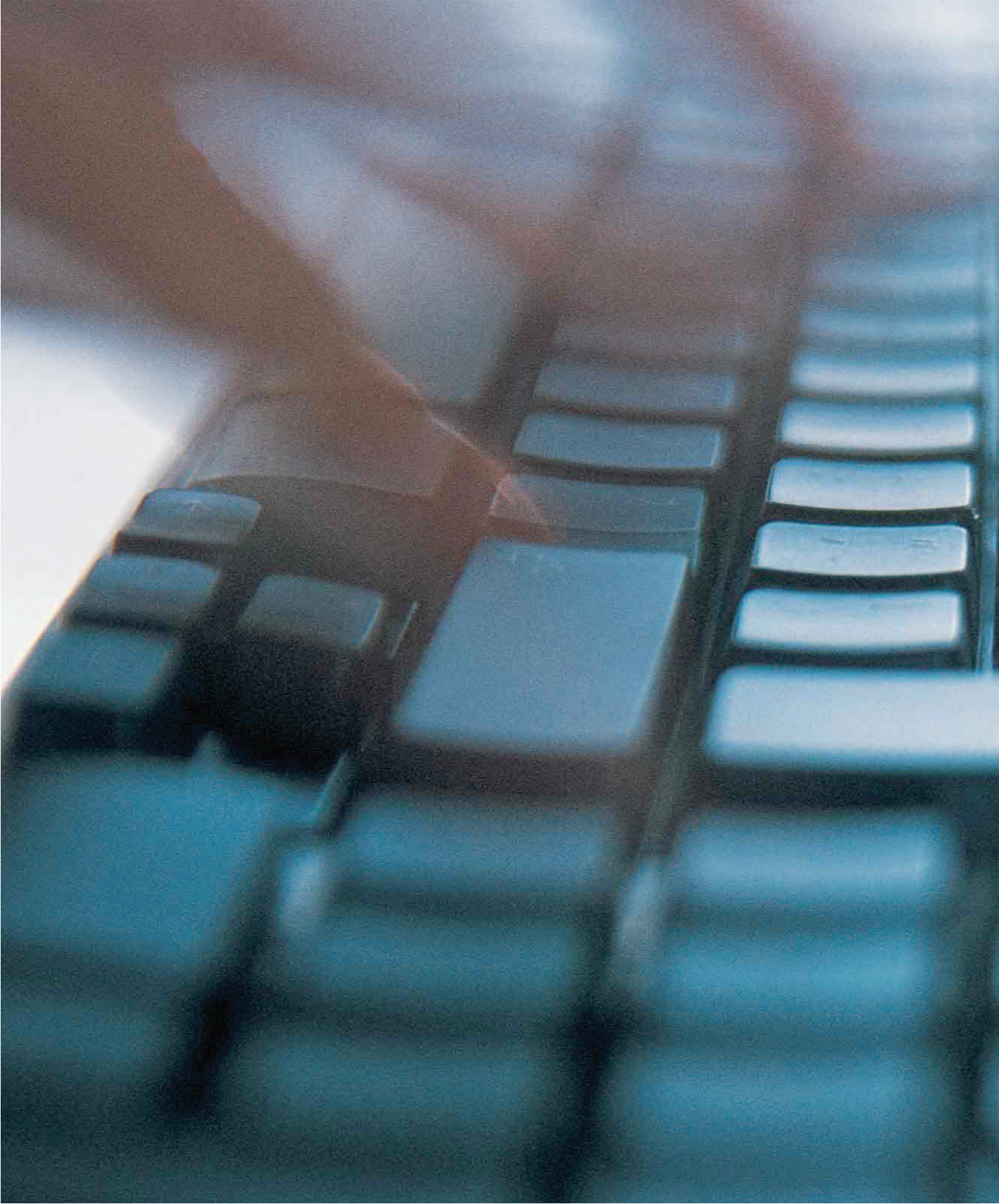



die Arbeit
work

das Büro 1 • office 1



die Büroausstattung • office equipment

der
Papierbehälter
paper tray



der Drucker | printer



das Faxgerät | fax machine

Vokabular • vocabulary

drucken
print (v)

vergrößern
enlarge (v)

kopieren
copy (v)

verkleinern
reduce (v)

Ich möchte fotokopieren.
I need to make some copies.

der Bürobedarf • office supplies

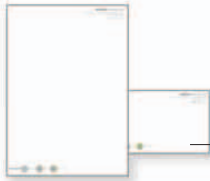

der Empfehlungszettel
notecard



der Briefumschlag
envelope

der Geschäftsbogen
stationery



das Klemmbrett
clipboard



der Notizblock
note pad



der Kartenreiter
tab

der Hängeordner
hanging file



der Teiler
divider

der Fächerordner
expanding file



der Aktenordner
box file

der Leitz-
Ordner
ring binder



der Terminkalender
personal organizer

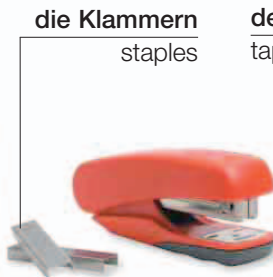

die Klammern
staples

der Hefter
stapler

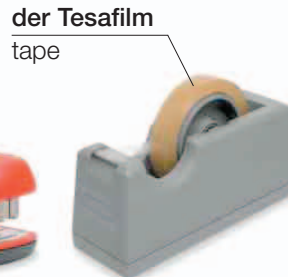

der Tesafilm
tape

der
Tesafilmhalter
tape dispenser



der Locher
hole punch



das Stempelkissen
ink pad

der Stempel
rubber stamp



das Gummiband
rubber band



die Papierklammer
bulldog clip



die Büroklammer
paper clip

der
Reißnagel
thumbtack



die Pinward | notice board

das Büro 2 • office 2

das Flipchart

flipchart

das Gestell

easel

das
Protokoll

minutes



die Sitzung | meeting

Vokabular • vocabulary

der Sitzungsraum

meeting room

teilnehmen

attend (v)

die Tagesordnung

agenda

den Vorsitz führen

chair (v)

Um wieviel Uhr ist die Sitzung?

What time is the meeting?

Was sind Ihre Geschäftszeiten?

What are your office hours?

der Sprecher

speaker



die Präsentation | presentation

das Geschäft • business

der Geschäftsmann
businessman

die Geschäftsfrau
businesswoman



das Arbeitsessen
business lunch



die Geschäftsreise
business trip

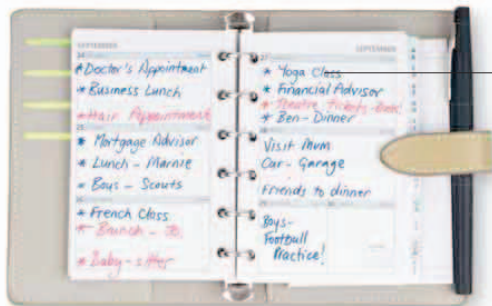

der Terminkalender | organizer

der Termin
appointment

der Kunde
client



**der
Generaldirektor**
CEO

das Geschäftsabkommen
business deal

Vokabular • vocabulary

die Firma
company

das Personal
staff

die Buchhaltung
accounts department

die Rechtsabteilung
legal department

die Zentrale
headquarters

die Lohnliste
payroll

die Marketingabteilung
marketing department

die Kundendienstabteilung
customer service department

die Zweigstelle
regional office

das Gehalt
salary

die Verkaufsabteilung
sales department

die Personalabteilung
human resources
department

der Computer • computer

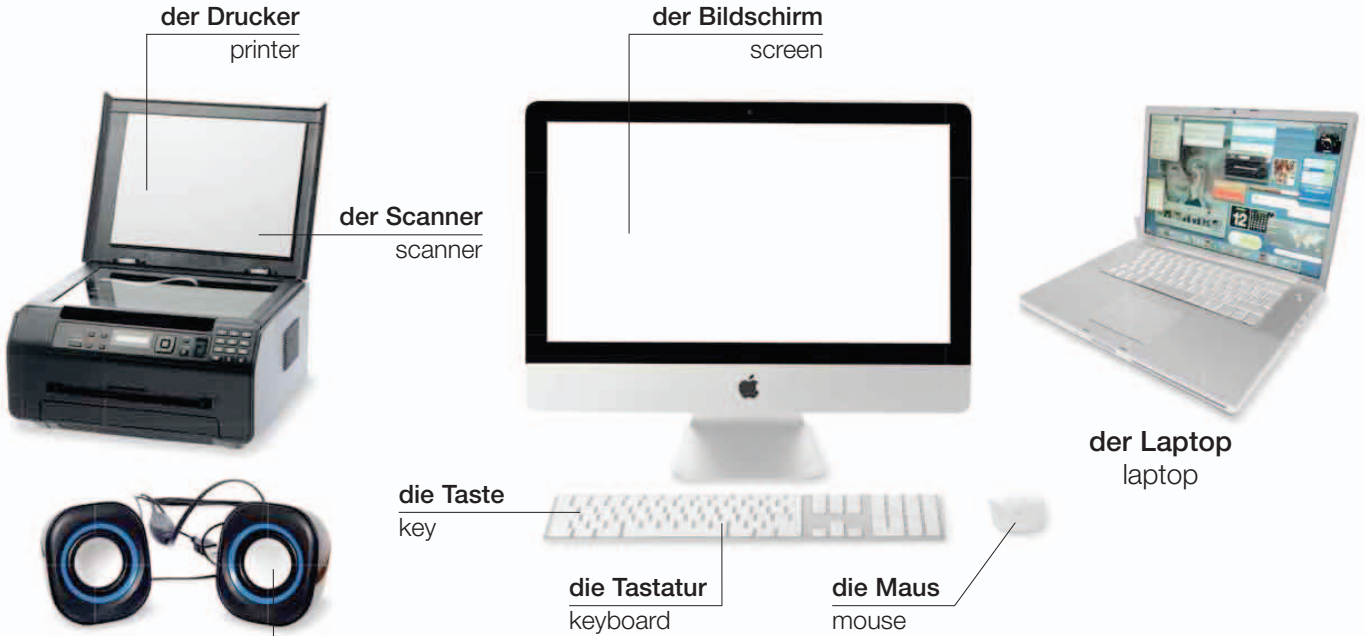

der Lautsprecher
speaker

die Hardware
hardware



Vokabular • vocabulary

das RAM RAM	die Software software	der Server server
die Bytes bytes	das Programm program	der Port port
das System system	das Netzwerk network	der Prozessor processor
der Speicher memory	die Anwendung application	das Stromkabel power cord



das Desktop • desktop

der Menübalken
menubar

die
Werkzeugleiste
toolbar

die Tapete
wallpaper

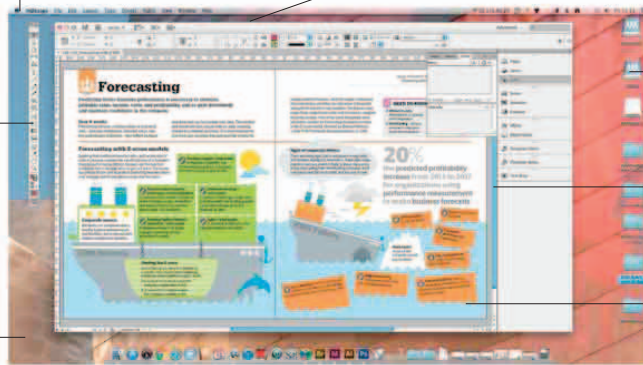

die Schriftart
font



die Datei
file



der Ordner
folder



der Papierkorb
trash

das Symbol
icon

der Scrollbalken
scrollbar

das Fenster
window

das Internet • internet

der Browser
browser



browsen
browse (v)

die Inbox
inbox

die Web-Site
website

die E-Mail • email

die E-Mail-Adresse
email address

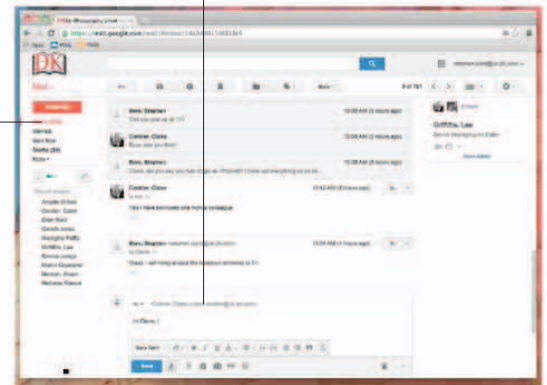

Vokabular • vocabulary

verbinden
connect (v)

der Serviceprovider
service provider

einloggen
log on (v)

herunterladen
download (v)

senden
send (v)

sichern
save (v)

installieren
install (v)

das E-Mail-Konto
email account

online
on-line

der Anhang
attachment

erhalten
receive (v)

suchen
search (v)

die Medien • media

das Fernsehstudio • television studio



Vokabular • vocabulary

der Kanal
channel

die Nachrichten
news

die Presse
press

senden
broadcast (v)

live
live

der Zeichentrickfilm
cartoon

**die Programm-
gestaltung**
programming

**der
Dokumentarfilm**
documentary

**die
Fernsehserie**
television series

**die
Spielshow**
game show

**vorher
aufgezeichnet**
pre-recorded

**die
Seifenoper**
soap opera



der Interviewer
interviewer



die Reporterin
reporter



der Teleprompter
teleprompter



die Nachrichtensprecherin
newscaster



die Schauspieler
actors



der Mikrophongalgen
sound boom



die Klappe
clapper board



das Set
movie set

das Radio • radio

der Tonmeister
sound technician

das Mischpult
mixing desk

das Mikrophon
microphone



das Tonstudio | recording studio

Vokabular • vocabulary

der DJ
DJ

die Kurzwelle
short wave

die Sendung
broadcast

die Mittelwelle
medium wave

die Wellenlänge
wavelength

die Frequenz
frequency

die Langwelle
long wave

die Lautstärke
volume

die Rundfunkstation
radio station

einstellen
tune (v)

digital
digital

analog
analog

das Recht • law

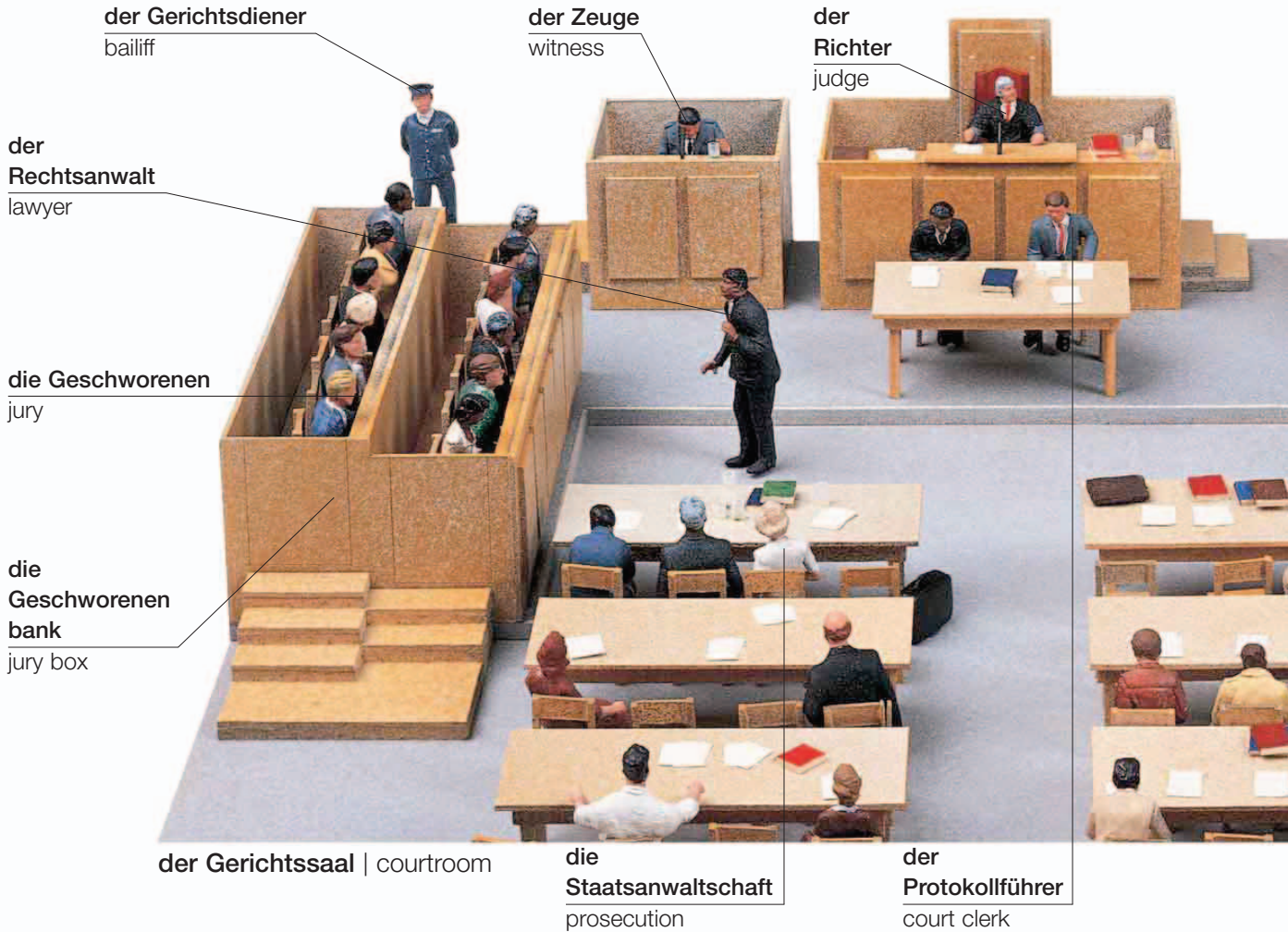

Vokabular • vocabulary

das Anwaltsbüro
lawyer's office

die Vorladung
summons

die Verfügung
writ

der Rechtsfall
court case

die Rechtsberatung
legal advice

die Aussage
statement

der Gerichtstermin
court date

die Anklage
charge

der Klient
client

der Haftbefehl
warrant

das Plädoyer
plea

der Angeklagte
accused

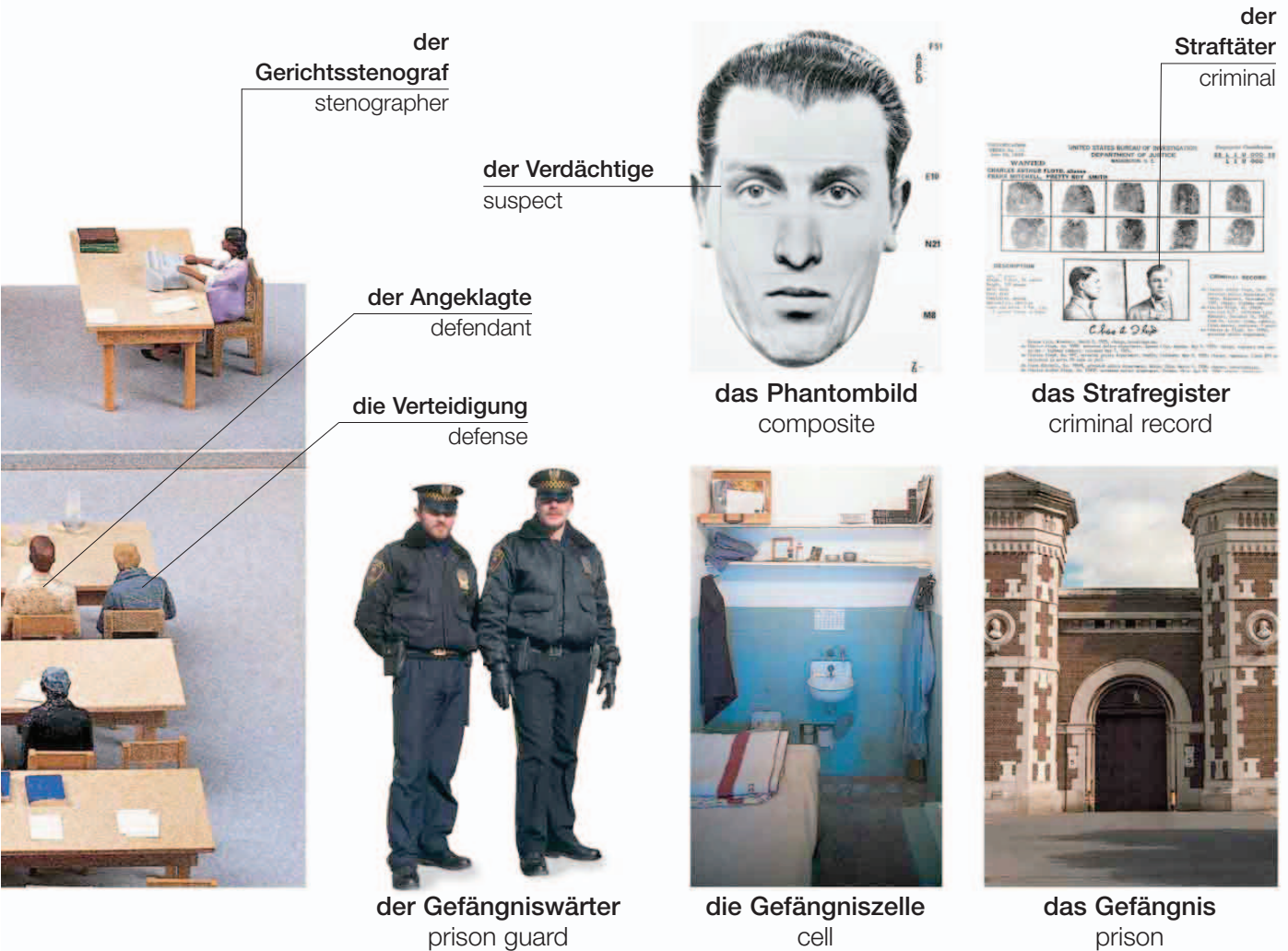

der
Gerichtsstenograf
stenographer

der Verdächtige
suspect

der
Straftäter
criminal

der Angeklagte
defendant

das Phantombild
composite

das Strafregister
criminal record

die Verteidigung
defense

der Gefängniswärter
prison guard

die Gefängniszelle
cell

das Gefängnis
prison

Vokabular • vocabulary

das Beweismittel
evidence

schuldig
guilty

die Kautions
bail

Ich möchte mit einem Anwalt
sprechen.

I want to see a lawyer.

das Urteil
verdict

freigesprochen
acquitted

die Berufung
appeal

Wo ist das Gericht?

Where is the courthouse?

unschuldig
innocent

das Strafmaß
sentence

die Haftentlassung auf
Bewährung
parole

Kann ich die Kautions leisten?

Can I post bail?

der Bauernhof 1 • farm 1



der Bauer
farmer

**der Gemüse-
garten**
vegetable
garden

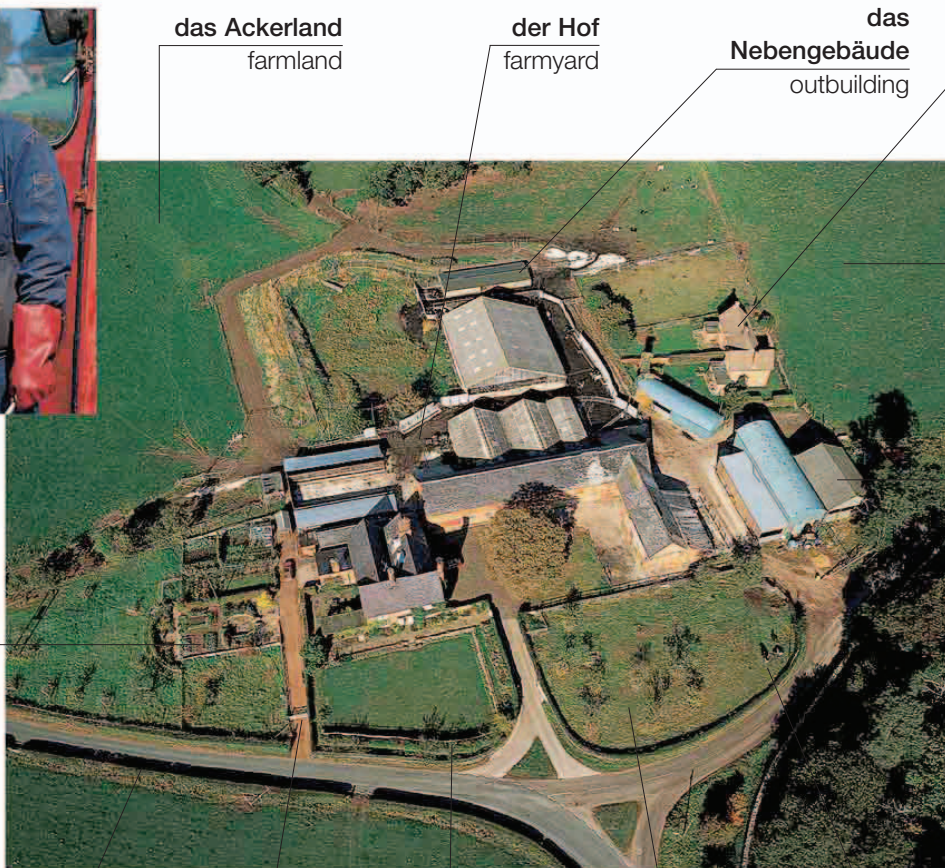

das Ackerland
farmland

der Hof
farmyard

**das
Nebengebäude**
outbuilding

**das
Bauernhaus**
farmhouse

das Feld
field

**die
Scheune**
barn

die Hecke
hedge

das Tor
gate

der Zaun
fence

die Weide
pasture

das Vieh
livestock



der Traktor | tractor

der Kultivator
cultivator



der Mähdrescher | combine

die landwirtschaftlichen Betriebe • types of farm

die Feldfrucht
crop



der Ackerbaubetrieb
crop farm



der Betrieb für
Milchproduktion
dairy farm

die Herde
flock



die Schaffarm
sheep farm



die Hühnerfarm
poultry farm

der Weinstock
vine

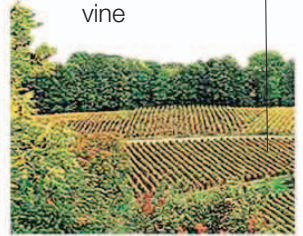

der Weinberg
vineyard



die Schweinefarm
pig farm



die Fischzucht
fish farm



der Obstanbau
fruit farm

die Tätigkeiten • actions

die
Furche
furrow



pflügen
plow (v)



säen
sow (v)



melken
milk (v)

füttern
feed (v)



bewässern | water (v)



ernten | harvest (v)

Vokabular • vocabulary

das Herbizid
herbicide

die Herde
herd

der Trog
trough

das Pestizid
pesticide

der Silo
silo

pflanzen
plant (v)

der Bauernhof 2 • farm 2

die Feldfrüchte • crops



der Weizen
wheat



der Mais
corn



die Gerste
barley



der Raps
rapeseed



die Sonnenblume
sunflower



der Ballen
bale

das Heu
hay



die Luzerne
alfalfa



der Tabak
tobacco



der Reis
rice



der Tee
tea



der Kaffee
coffee



der Flachs
flax



das Zuckerrohr
sugarcane



die Baumwolle
cotton



die Vogelscheuche
scarecrow

das Vieh • livestock



das Ferkel
piglet



das Kalb
calf



der Stier
bull



das Schaf
sheep

das Schwein
pig

die Kuh
cow



das Lamm
lamb



das Zicklein
kid

die Ziege
goat



das Fohlen
foal

das Pferd
horse



der Esel
donkey

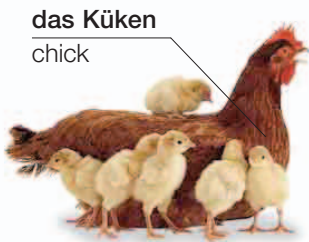

das Küken
chick

das Huhn
chicken



der Hahn
rooster



der Truthahn
turkey

das
Entenküken
duckling



die Ente
duck



der Stall
stable



der Pferch
pen



der Hühnerstall
chicken coop



der Schweinestall
pigsty

der Bau • construction

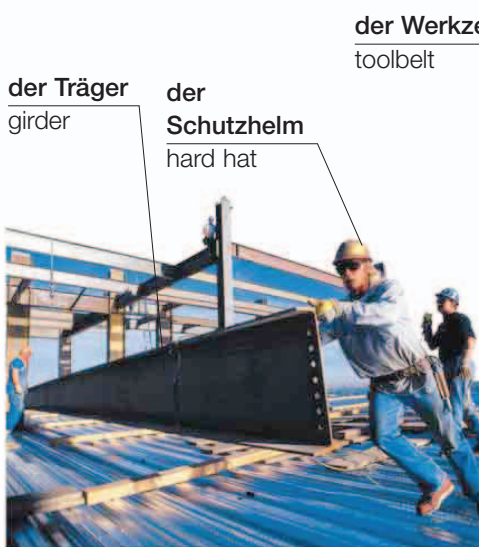
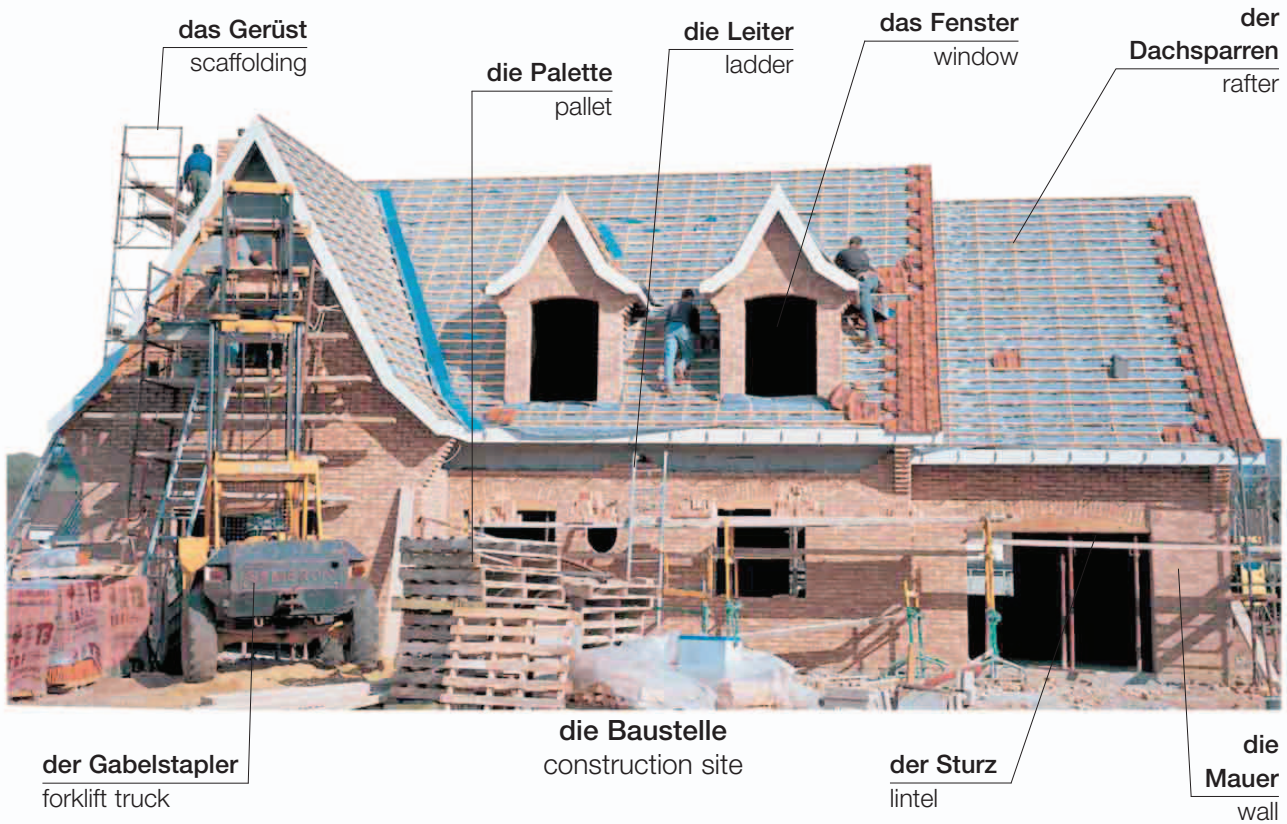

bauen
build (v)

der Werkzeuggürtel
toolbelt



der Bauarbeiter
carpenter

der Zement
cement



das Material • materials



der Ziegelstein
brick



das Bauholz
lumber



der Dachziegel
roof tile



der Betonblock
concrete block

die Werkzeuge • tools

der Mörtel
mortar

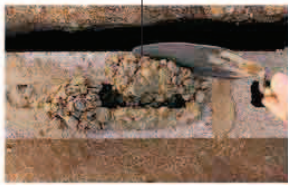

die Kelle
trowel



die Wasserwaage
level



der
Vorschlaghammer
sledgehammer

die
Spitzhacke
pickax

die
Schaufel
shovel

der Stiel
handle

die Maschinen •
machinery



die Walze
roller



der Kipper
dump truck



der Kran | crane

die Stütze
support

der
Haken
hook

die Straßenarbeiten • roadworks

der Asphalt
asphalt

der
Leitkegel
cone



der
Pressluftbohrer
jackhammer

der
Neubelag
resurfacing



der Bagger
excavator

die Berufe 1 • occupations 1



der Schreiner
carpenter



der Elektriker
electrician



der Klempner
plumber



der Bauhandwerker
construction worker



der Gärtner
gardener

**der
Staubsauger**
vacuum
cleaner



der Gebäudereiniger
cleaner



der Mechaniker
mechanic



der Metzger
butcher



der Friseur
hairdresser



die Fischhändlerin
fish seller



der Gemüsehändler
produce seller



die Floristin
florist



der Friseur
barber



der Juwelier
jeweler



die Verkäuferin
store clerk



die Immobilienmaklerin
realtor



der Optiker
optometrist



die Zahnärztin
dentist

die Maske
mask



der Arzt
doctor



die Apothekerin
pharmacist



die Krankenschwester
nurse



die Tierärztin
veterinarian



der Bauer
farmer



der Fischer
fisherman

das
Maschinen-
gewehr
machine-
gun



der Soldat
soldier



der Polizist
police officer

das Abzeichen
badge

die Uniform
uniform



der Wächter
security guard



der Seemann
sailor



der Feuerwehrmann
firefighter

die Berufe 2 • occupations 2



der Rechtsanwalt
lawyer



der Wirtschaftsprüfer
accountant

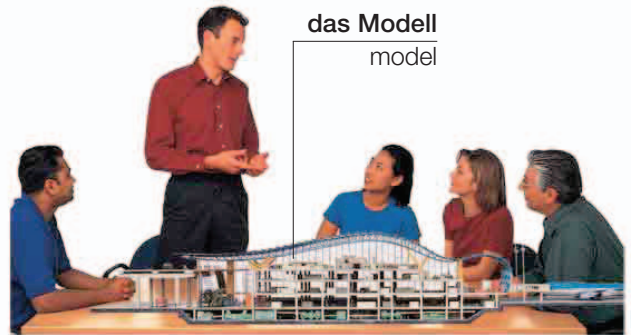

der Architekt
architect

das Modell
model



die Wissenschaftlerin
scientist



die Lehrerin
teacher



der Bibliothekar
librarian



die Empfangsdame
receptionist



die Posttasche
mailbag

der Briefträger
mail carrier



der Busfahrer
bus driver



der Lastwagenfahrer
truck driver



der Taxifahrer
cab driver



der Pilot
pilot



die Flugbegleiterin
flight attendant



die Reisebürokauffrau
travel agent

die Kochmütze
chef's hat



der Koch
chef

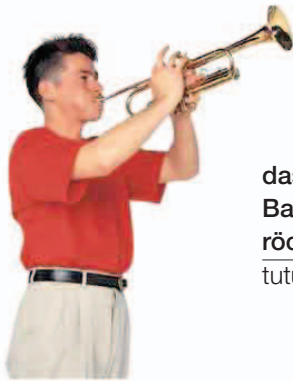

der Musiker
musician



das
Ballett
röckchen
tutu

die Tänzerin
dancer



die Schauspielerin
actress



die Sängerin
singer



die Kellnerin
waitress



der Barkeeper
bartender



der Sportler
sportsman



der Bildhauer
sculptor



die Malerin
painter



der Fotograf
photographer



die Nachrichtensprecherin
newscaster



die Notizen
notes

der Journalist
journalist



die Redakteurin
editor



der Designer
designer



die Damenschneiderin
seamstress



der Schneider
tailor





der Verkehr
transportation



die Straßen • roads

die Autobahn
freeway

die Mautstelle
toll booth

die Straßen-
markierungen
road markings

die
Zufahrtsstraße
frontage road

Einbahn-
one-way

die Verkehrsinsel
divider

die Kreuzung
interchange

die
Verkehrs-
ampel
traffic light

der
Lastwagen
truck

der Mittelstreifen
median strip

die rechte Spur
right lane

die mittlere Spur
center lane

die Überholspur
left lane

die Ausfahrt
exit ramp

der Verkehr
traffic

die
Überführung
overpass

der Seitenstreifen
shoulder

die Unterführung
underpass





der
Fußgängerüberweg
crosswalk



die Notrufsäule
emergency phone



der
Behindertenparkplatz
disabled parking



der Verkehrsstau
traffic jam

das Navi
satnav



die Parkuhr
parking meter



der
Verkehrspolizist
traffic policeman

Vokabular • vocabulary

parken
park (v)

die Umleitung
detour

der Kreisverkehr
roundabout

überholen
pass (v)

die Leitplanke
guardrail

Ist dies die Straße
nach...?
Is this the road to...?

rückwärts
fahren
back up (v)

die
Straßenbaustelle
road construction

Wo kann ich
parken?
Where can I park?

fahren
drive (v)

die
Schnellstraße
divided highway

die
abschleppen
tow away (v)

die Verkehrsschilder • road signs



keine Einfahrt
do not enter



die Geschwindig-
keitsbegrenzung
speed limit



Gefahr
hazard



Halten
verboten
no stopping



rechts abbiegen
verboten
no right turn

der Bus • bus

der
Fahrsitz
driver's seat

der Haltegriff
handrail

die Automattür
automatic door

das Vorderrad
front wheel

das Gepäckfach
luggage hold



die Tür | door



der Reisebus | long-distance bus

die Bustypen • types of buses



die Liniennummer
route number

der Fahrer
driver

der Doppeldecker
double-decker bus



die Straßenbahn
tram



der Obus
trolley bus



der Schulbus | school bus



das Hinterrad
rear wheel

das Fenster
window

der Halteknopf
stop button



der Fahrschein
bus ticket



die Klingel
bell



der Busbahnhof
bus station



die
Bushaltestelle
bus stop

Vokabular • vocabulary

der Fahrpreis
fare

der Rollstuhlzugang
wheelchair access

der Fahrplan
schedule

das Wartehäuschen
bus shelter

Halten Sie am...?
Do you stop at...?

Welcher Bus fährt nach...?
Which bus goes to...?



der Kleinbus
minibus



der Touristenbus | tour bus



der Zubringer | shuttle bus

das Auto 1 • car 1

das Äußere • exterior



die Wagentypen • types



das Elektroauto
electric car



die Fließhecklimousine
hatchback



die Limousine
sedan



der Kombiwagen
station wagon



das Kabriolett
convertible



das Sportkabriolett
sports car



die Großraum-
limousine
minivan



der Geländewagen
four-wheel drive

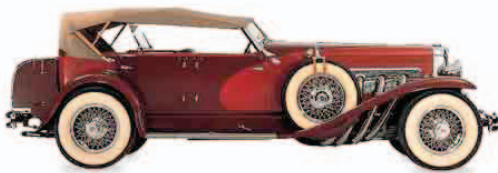

das Vorkriegsmodell
vintage



die verlängerte Limousine
limousine

die Tankstelle • gas station

die Zapfsäule
gas pump

der Benzinpreis
price



der Tankstellenplatz
forecourt

Vokabular • vocabulary

das Benzin verbleit die Autowaschanlage
gasoline leaded carwash

bleifrei das Öl das Frostschutzmittel
unleaded oil antifreeze

die Werkstatt der Diesel die Scheibenwaschanlage
garage diesel screenwash

Voll tanken, bitte.
Fill it up, please.

das Auto 2 • car 2

die Innenausstattung • interior

der Rücksitz
back seat

die Armstütze
armrest

die Kopfstütze
headrest

die
Türverriegelung
door lock

der Türgriff
handle



Vokabular • vocabulary

zweitürig
two-door

viertürig
four-door

die Zündung
ignition

die Bremse
brake

das Gaspedal
accelerator

dreitürig
hatchback

**mit
Handschaltung**
manual

**mit
Automatik**
automatic

**die
Kupplung**
clutch

die Klimaanlage
air conditioning

Wie komme ich nach...?
Can you tell me the way to...?

Wo ist hier ein Parkplatz?
Where is the parking lot?

Kann ich hier parken?
Can I park here?

die Armaturen • controls

das
Lenkrad
steering
wheel

die Hupe
horn

das Armaturenbrett
dashboard

die Warnlichter
hazard lights

das GPS-System
satellite navigation



die Linkssteuerung | left-hand drive

die
Temperaturanzeige
temperature gauge

der Drehzahlmesser
tachometer

der
Tachometer
speedometer

die
Kraftstoffanzeige
fuel gauge

die
Autostereoanlage
car stereo

der Lichtschalter
light switch

der Heizungsregler
heater controls

der
Kilometerzähler
odometer

der Schalthebel
gearstick

der Airbag
air bag



die Rechtssteuerung | right-hand drive

das Auto 3 • car 3

die Mechanik • mechanics

der Scheiben
putzmittelbehälter
screen wash reservoir

der Ölmesstab
dipstick

der Luftfilter
air filter

der
Bremsflüssigkeitsbehälter
brake fluid reservoir

die
Batterie
battery

die
Karosserie
bodywork

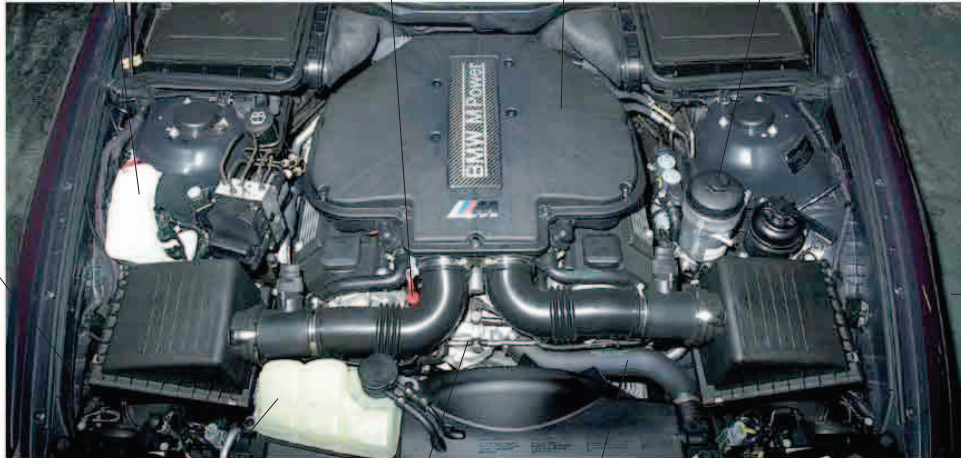

der Kühlmittelbehälter
coolant reservoir

der
Zylinderkopf
cylinder head

das Rohr
pipe

das
Schiebedach
sunroof

der Kühler
radiator

der Ventilator
fan

der Motor
engine

die
Radkappe
hubcap

das
Getriebe
gearbox

die
Transmission
transmission

die
Kardanwelle
driveshaft

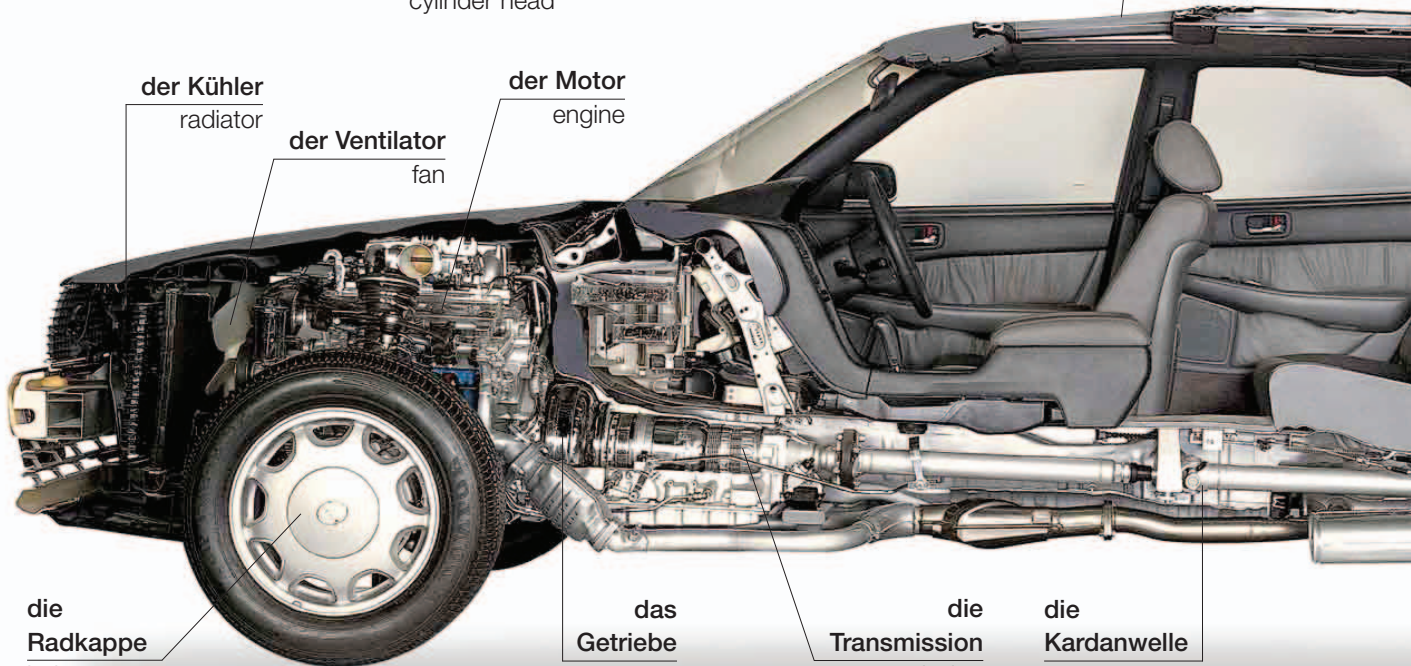

die Reifenpanne • flat tire

das Ersatzrad
spare tire

der Radschlüssel
tire iron

die Radmuttern
wheel nuts

der
Wagenheber
jack

ein Rad wechseln
change a tire (v)

das Dach
roof

die Aufhängung
suspension

der Auspufftopf
muffler

der Auspuff
exhaust pipe

Vokabular • vocabulary

der Autounfall
car accident

der Nockenriemen
cam belt

die Panne
breakdown

der Turbolader
turbocharger

die Versicherung
insurance

der Verteiler
distributor

der Abschleppwagen
tow truck

die Einstellung
timing

der Mechaniker
mechanic

das Chassis
chassis

der Reifendruck
tire pressure

die Handbremse
parking brake

der Sicherungskasten
fuse box

die Lichtmaschine
alternator

die Zündkerze
spark plug

.....
Ich habe eine Panne.
My car has broken down.

der Keilriemen
fan belt

der Benzintank
gas tank

Mein Auto springt nicht an.
My car won't start.

das Motorrad • motorcycle

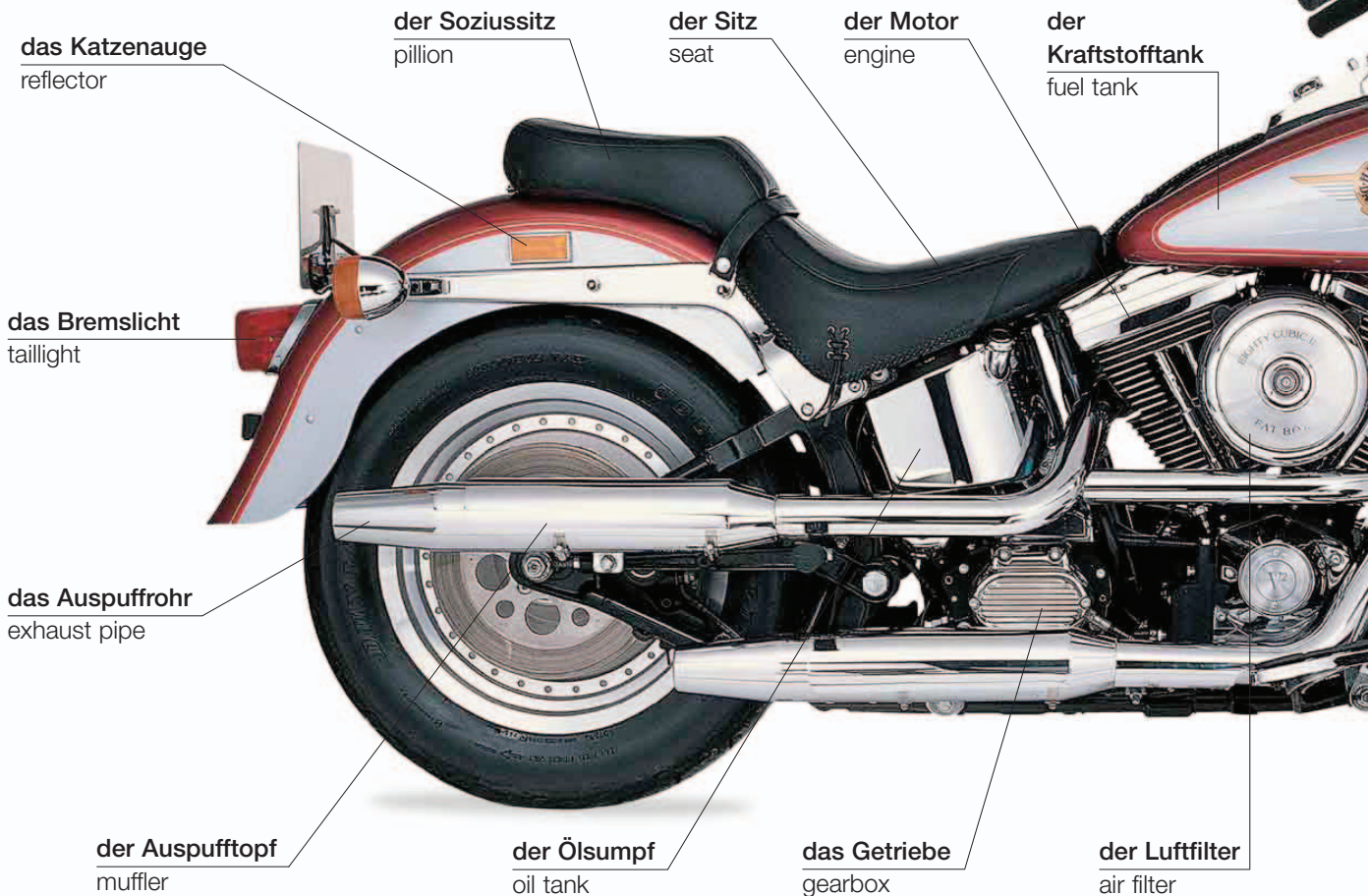
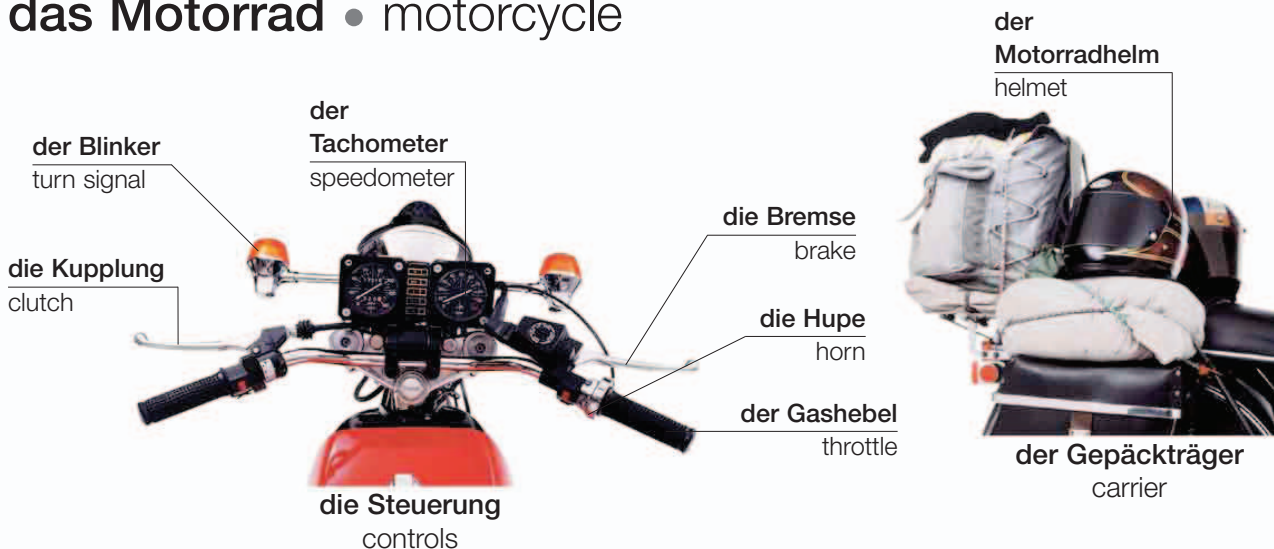

die Typen • types



die Rennmaschine | racing bike

die Windschutzscheibe
windshield



der Tourer | tourer



das Geländemotorrad | dirt bike

der Motor
radständer
stand



der Roller | scooter

das Visier
visor

der Lederanzug
leathers

der
Leuchtstreifen
reflector strap

der
Knieschützer
knee pad

die Kleidung | clothing

der Scheinwerfer
headlight

die
Aufhängung
suspension

das
Schutzblech
mudguard

das Bremspedal
brake pedal

die Achse
axle

der Reifen
tire

das Fahrrad • bicycle



das Tandem
tandem



das Rennrad
racing bike



das Mountainbike
mountain bike



das Tourenfahrrad
touring bike



das Straßenrad
road bike

der Sattel
saddle

die Sattelstütze
seat post

die
Wasserflasche
water bottle

der Rahmen
frame

die Felgenbremse
brake

die Nabe
hub

die Gänge
gears

die Felge
rim

der Reifen
tire

die Fahrradkette
chain

das Pedal
pedal

das Zahnrad
cog



der Fahrradhelm
helmet



der Fahrradweg | cycle lane



Vokabular • vocabulary

das Rücklicht rear light	die Stützräder training wheels	das Kabel cable	der Korb basket	der Riemen toe strap	bremsen brake (v)
die Fahrradlampe headlight	der Fahrradständer kickstand	die Bremsbacke brake block	die Reifenpanne flat tire	der Rennbügel toe clip	schalten change gears (v)
der Rückstrahler reflector	der Fahrradständer bike rack	das Kettenzahnrad sprocket	der Dynamo dynamo	treten pedal (v)	Rad fahren cycle (v)

der Zug • train

der Wagen
car

der Bahnsteig
platform

der Kofferkuli
cart



der Bahnhof | train station

die Gleisnummer
platform number

der Pendler
commuter

die Zugtypen • types of train



die Dampflokomotive
steam train



die Lokomotive
engine

die Diesellokomotive | diesel train

der Führerstand
engineer's cab

die Schiene
rail



die Elektrolokomotive
electric train



der Hochgeschwindigkeitszug
high-speed train



die Einschienenbahn
monorail



die U-Bahn
subway



die Straßenbahn
tram



der Güterzug
freight train



das Abteil
compartment

der Lautsprecher
public address system

der Fahrplan
schedule

die Gepäckablage
luggage rack

das Zugfenster
window

das Gleis
track

die Tür
door

der Sitz
seat



die Fahrkarte
ticket



die Eingangssperre
ticket gate



der Speisewagen | dining car



die Bahnhofshalle | concourse



das Schlafabteil
sleeping compartment

Vokabular • vocabulary

das Bahnnetz
rail network

der U-Bahnplan
subway map

der Fahrkartenschalter
ticket office

die stromführende
Schiene
live rail

der Intercity
express train

die Verspätung
delay

der Schaffner
ticket inspector

das Signal
signal

die Stoßzeit
rush hour

der Fahrpreis
fare

umsteigen
change (v)

der Nothebel
emergency lever

das Flugzeug • aircraft

das Verkehrsflugzeug • airliner



die Kabine • cabin





der Heißluftballon
hot-air balloon



das Ultraleichtflugzeug
ultralight



das Segelflugzeug
glider



der Doppeldecker
biplane

der Propeller
propeller



das Leichtflugzeug
light aircraft



das Wasserflugzeug
sea plane



der Privatjet
private jet



die Rakete
missile

das Jagdflugzeug
fighter plane

das Rotorblatt
rotor blade



der Hubschrauber
helicopter



das Bombenflugzeug
bomber

Vokabular • vocabulary

der Pilot
pilot

starten
take off (v)

landen
land (v)

die Economyclass
economy class

das Handgepäck
carry-on luggage

der Kopilot
copilot

fliegen
fly (v)

die Höhe
altitude

die Businessclass
business class

der Sicherheitsgurt
seat belt

der Flughafen • airport



das Vorfeld
apron

der
Gepäckanhänger
baggage trailer

der Terminal
terminal

das Versorgungsfahrzeug
service vehicle

die Fluggastbrücke
walkway

das Verkehrsflugzeug | airliner

Vokabular • vocabulary

das Gepäckband
carousel

die Flugnummer
flight number

die Start- und Landebahn
runway

der Urlaub
vacation

der Auslandsflug
international flight

die Passkontrolle
immigration

die Sicherheitsvorkehrungen
security

einen Flug buchen
book a flight (v)

der Inlandsflug
domestic flight

der Zoll
customs

die Gepäckröntgenmaschine
X-ray machine

einchecken
check in (v)

die Flugverbindung
connection

das Übergepäck
excess baggage

der Urlaubsprospekt
travel brochure

der Kontrollturm
control tower

das
Handgepäck
carry-on
luggage

das Gepäck
luggage

der Kofferkuli
cart



der Abfertigungsschalter
check-in desk



das Visum
visa

der Pass | passport



die Passkontrolle
passport control

die Bordkarte
boarding pass



das Flugticket
ticket



die Abflughalle
departure lounge

die Gatenummer
gate number

der Abflug
departures



die Fluginformationsanzeige
information screen

das Reiseziel
destination

die Ankunft
arrivals



der Duty-free-Shop
duty-free shop



die Gepäckaushabe
baggage claim



der Taxistand
taxi stand



der Autoverleih
car rental

das Schiff • ship

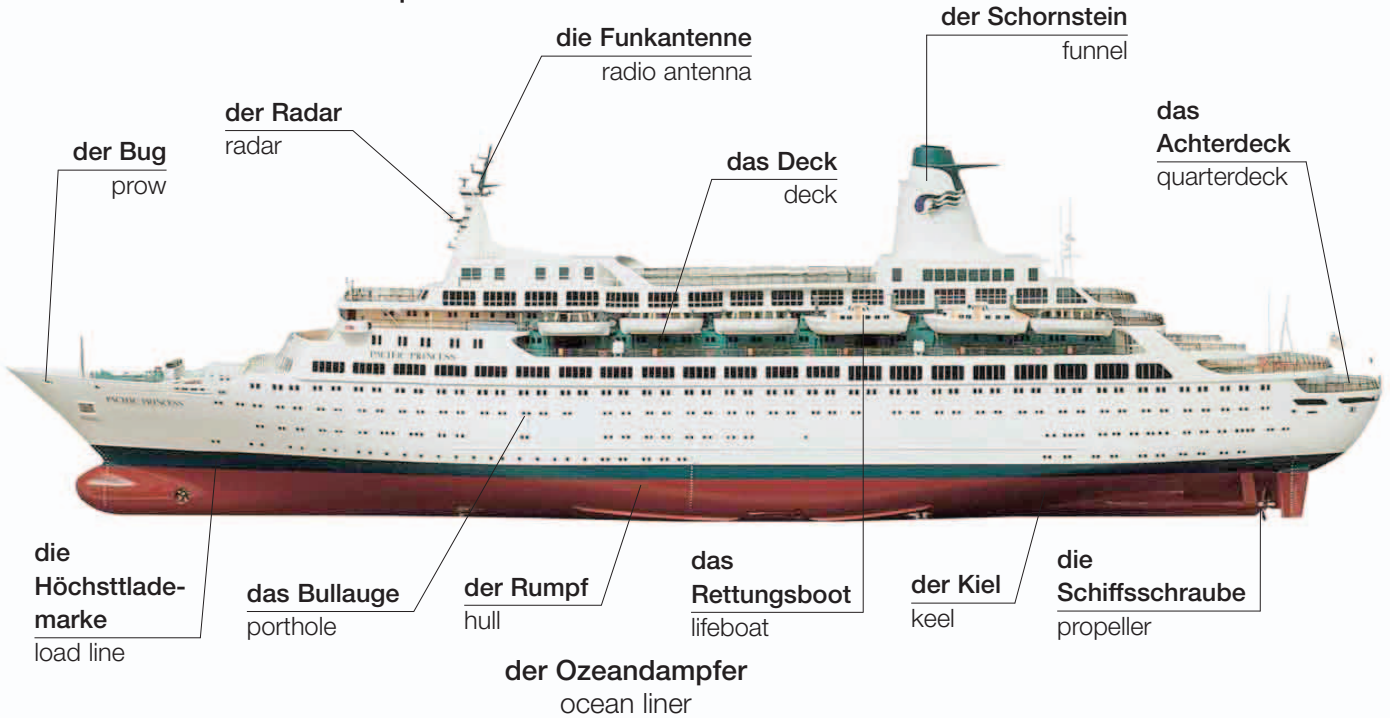

die Kommandobrücke
bridge



der Maschinenraum
engine room



die Kabine
cabin



die Kombüse
galley

Vokabular • vocabulary

das Dock
dock

die Ankerwinde
windlass

der Hafen
port

der Kapitän
captain

die Landungsbrücke
gangway

das Rennboot
speedboat

der Anker
anchor

das Ruderboot
rowboat

der Poller
bollard

das Kanu
canoe

andere Schiffe • other ships



die Fähre
ferry

der
Außenbordmotor
outboard motor



das Schlauchboot
inflatable dinghy



das Tragflügelboot
hydrofoil



die Jacht
yacht



der Katamaran
catamaran



der Schleppdampfer
tugboat



das Luftkissenboot
hovercraft



das Containerschiff
container ship

die Takelung
rigging



das Segelboot
sailboat

der
Frachtraum
hold



das Frachtschiff
freighter



der Öltanker
oil tanker



der Flugzeugträger
aircraft carrier



das Kriegsschiff
battleship

der
Kommandoturm
conning tower



das U-Boot
submarine

der Hafen • port

das
Warenlager
warehouse

der Kran
crane

der Gabelstapler
forklift truck

die Zufahrtsstraße
access road

das Zollamt
customs house



das Dock
dock

der Container
container

der Kai
dock

die Fracht
cargo



der Containerhafen | container port

der Fährterminal
ferry terminal

die Fähre
ferry

der
Fahrkartenschalter
ticket office

der
Passagier
passenger



der Passagierhafen | passenger port

das Netz
net

das Fischerboot
fishing boat

die Verankerung
mooring



der Fischereihafen
fishing port



die Marina
marina



der Hafen
harbor



der Pier
pier



der Landungssteg
jetty



die Werft
shipyard



der Leuchtturm
lighthouse

die Laterne
lamp



die Boje
buoy

Vokabular • vocabulary

die Küstenwache
coastguard

festmachen
moor (v)

an Bord gehen
board (v)

der Hafenmeister
harbor master

anlegen
dock (v)

von Bord gehen
disembark (v)

das Trockendock
dry dock

den Anker
werfen
drop anchor (v)

auslaufen
set sail (v)



PRESSION

ULTRA
3

DUNLOP
DDH III
4

TOP-FLITE

DUNLOP

TOUR
EDITION
1

ProStaff
4

SAVING SPRINGS
GOLF CLUB

ProStaff
4

TOP-FLITE
HOT XL
4

RAM TOUR
1

MAXFLI
1

DISTANCE

TOP-FLITE
STRATA
3

ProStaff



der Sport
sports

der Football • football

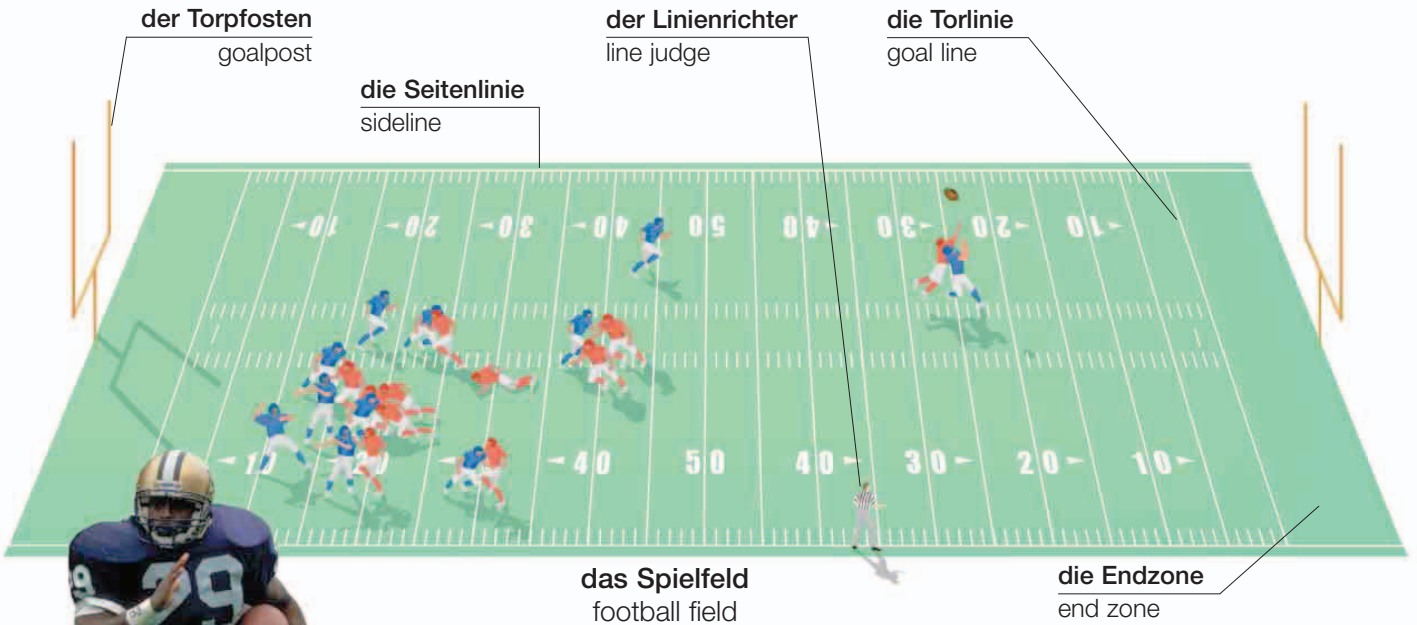

der Football
football

das Polster
pads

der Helm
helmet

der Stiefel
shoe



angreifen
tackle (v)



den Ball abgeben
pass (v)



fangen
catch (v)

der Footballspieler
football player

Vokabular • vocabulary

die Auszeit
time out

die Mannschaft
team

die Verteidigung
defense

der Cheerleader
cheerleader

Wie ist der Stand?
What is the score?

das unsichere Fangen des Balls
fumble

der Angriff
attack

der Spielstand
score

der Touchdown
touchdown

Wer gewinnt?
Who is winning?

das Rugby • rugby

das Tor
goal

der Torraum
in-goal area

die Seitenlinie
touch line

die Fahne
flag

die Feldauslinie
dead ball line

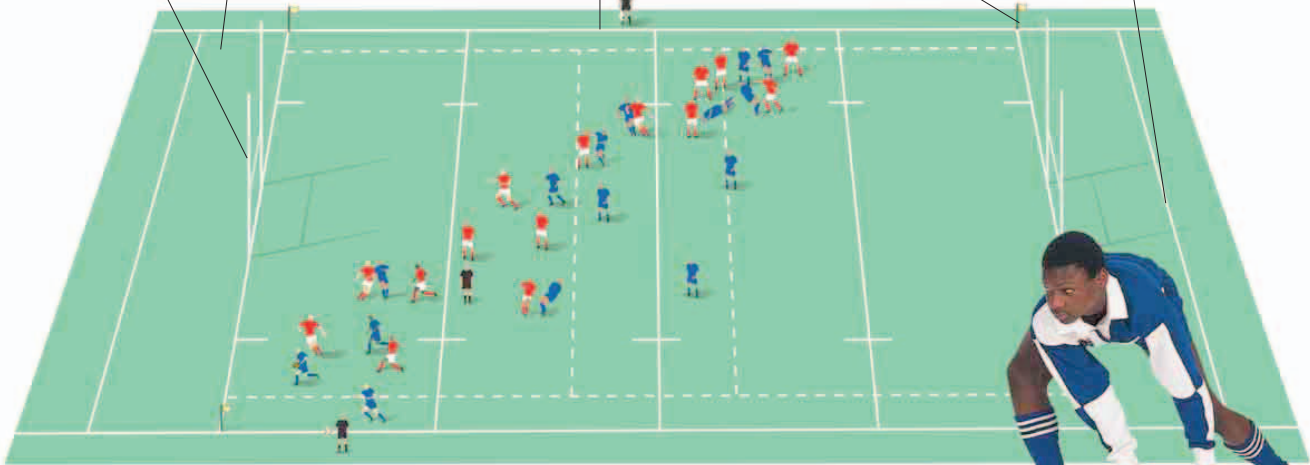

das Spielfeld | rugby field



der Rugbyball
ball



kicken
kick (v)

das
Rugbytrikot
rugby
uniform



den Ball abgeben
pass (v)



angreifen
tackle (v)



der Versuch
try

werfen
throw (v)

der Rugbyspieler
player



das offene Gedränge | ruck



das Gedränge | scrum

der Fußball • soccer



der Fußball
football

der Torwart
goalkeeper

der Dress
soccer
uniform

**der
Mittelstürmer**
forward

der Schiedsrichter
referee

der Mittelkreis
center circle

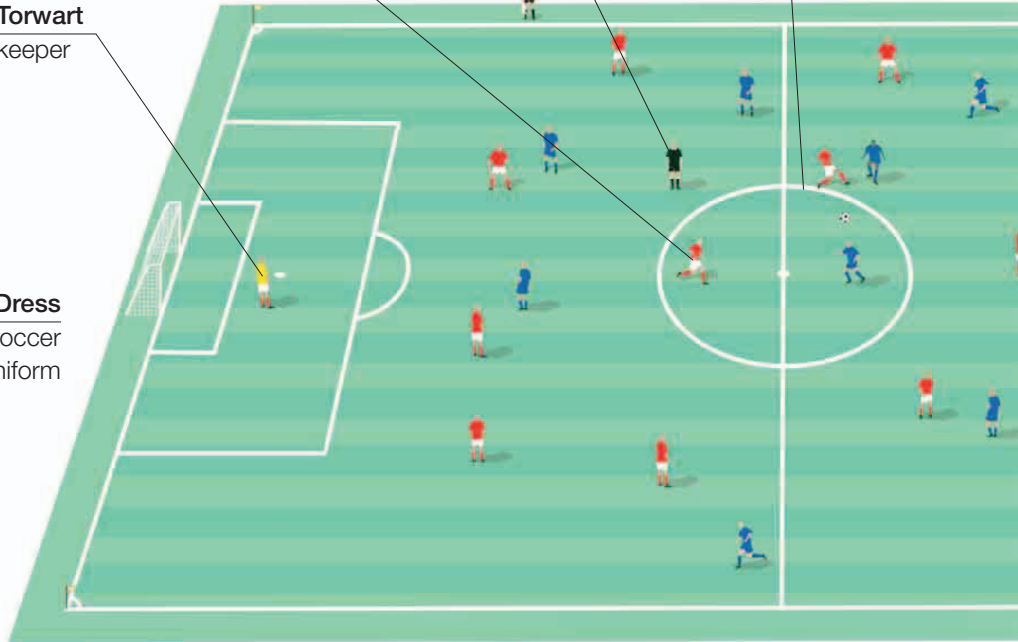

der Fußballspieler
soccer player

das Fußballfeld
soccer field

der Torpfosten
goalpost

die Querlatte
crossbar

das Tornetz
net



das Tor | goal



dribbeln | dribble (v)



köpfen
head (v)



die Mauer
wall

der Freistoß | free kick

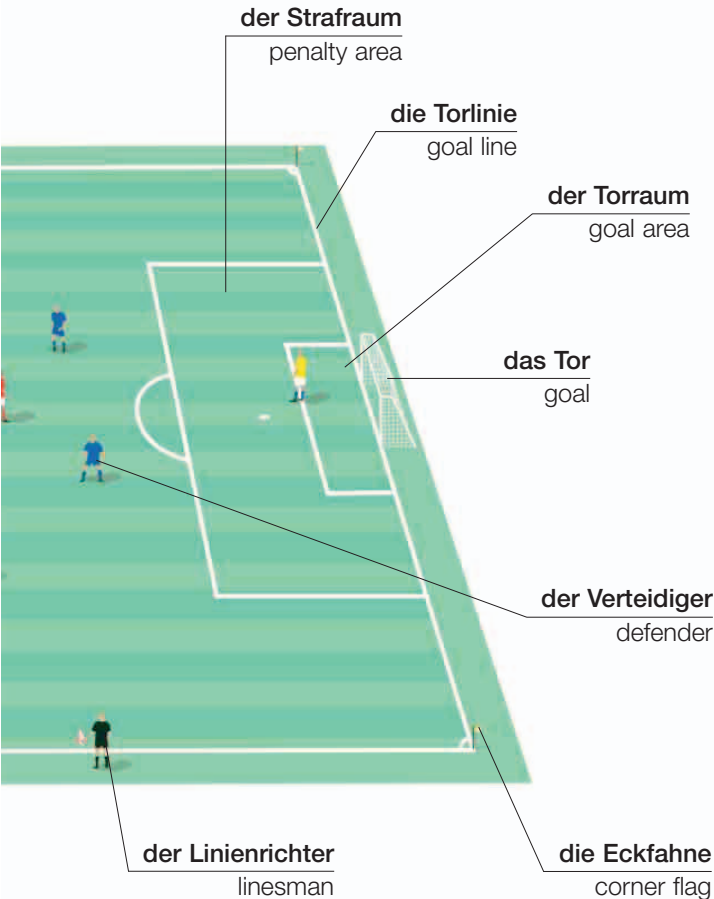

der Einwurf
throw-in



kicken
kick (v)



den Ball abgeben
pass (v)



der
Fußballschuh
shoe

schießen
shoot (v)



halten
save (v)

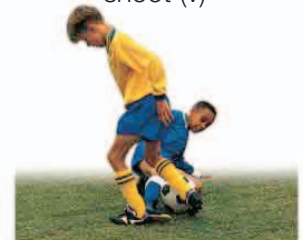

angreifen
tackle (v)

Vokabular • vocabulary

das Stadion
stadium

das Foul
foul

die gelbe Karte
yellow card

die Liga
league

die Verlängerung
extra time

der Elfmeter
penalty

der Eckball
corner

das Abseits
off-side

die Halbzeit
half time

der Ersatzspieler
substitute

ein Tor schießen
score a goal (v)

die rote Karte
red card

der Platzverweis
send off

das Unentschieden
tie

die Auswechslung
substitution

das Hockey • hockey

das Eishockey • ice hockey

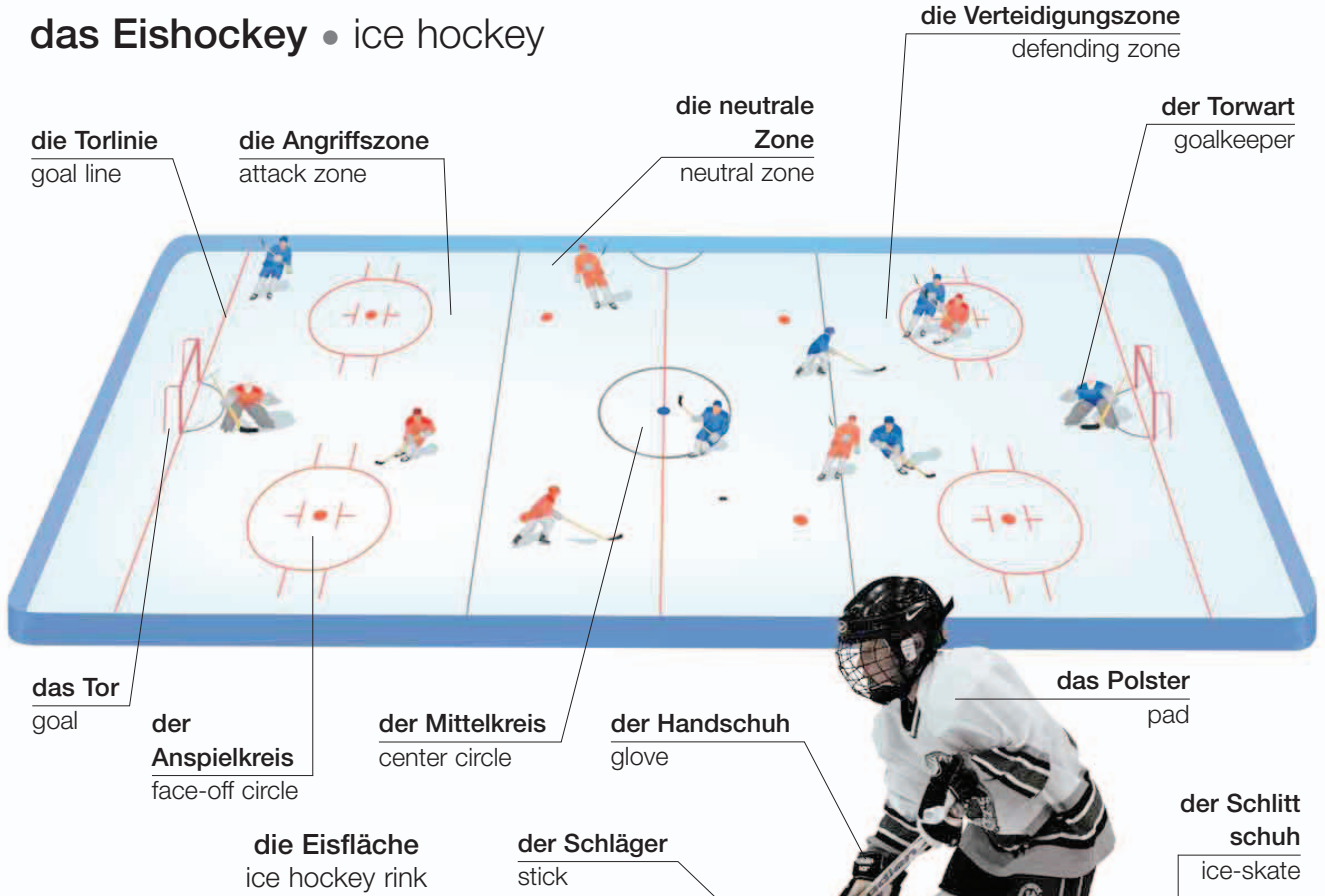

das Hockey • field hockey

der Hockeyschläger
hockey stick



das Kricket • cricket

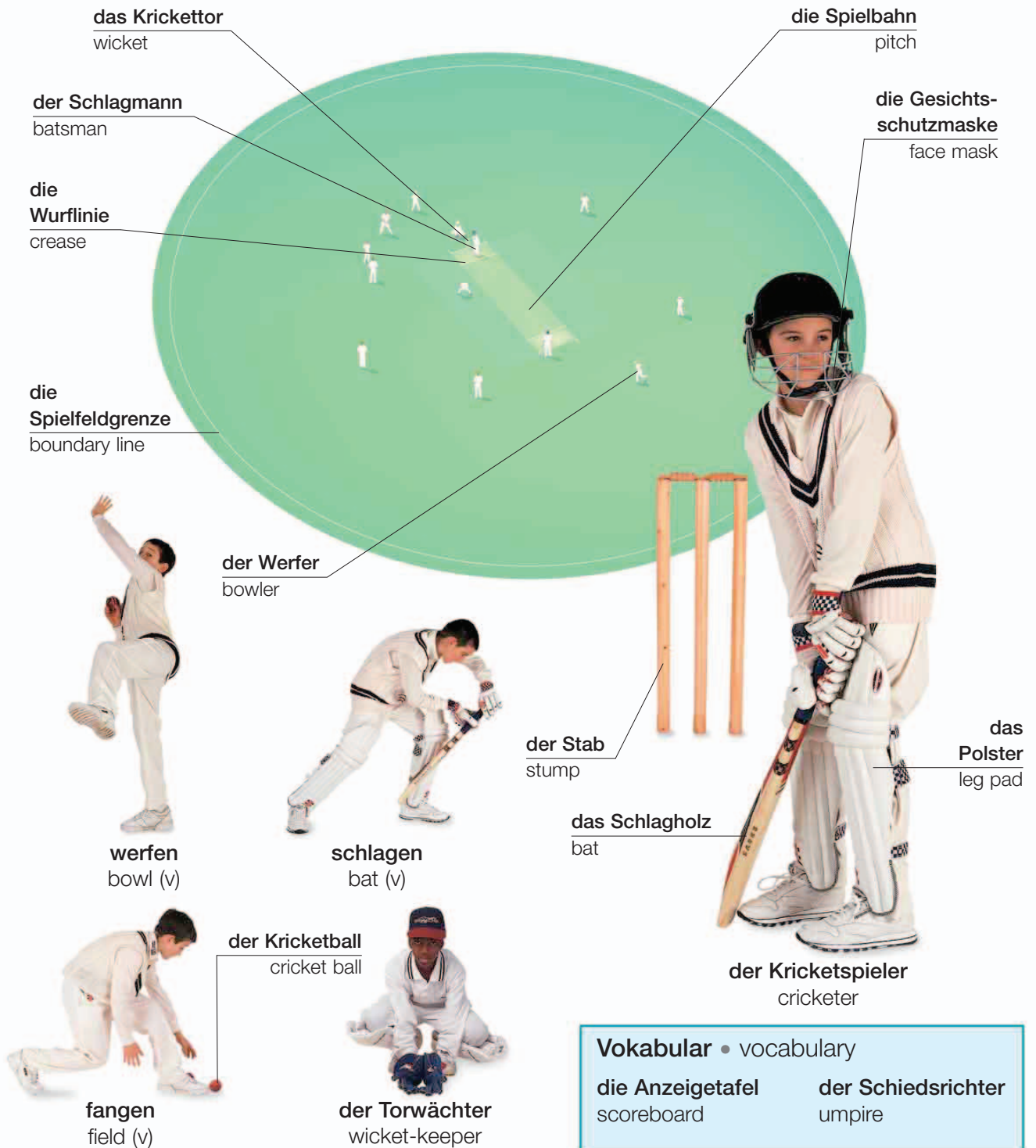

Vokabular • vocabulary

die Anzeigetafel scoreboard	der Schiedsrichter umpire
--------------------------------	------------------------------

der Basketball • basketball

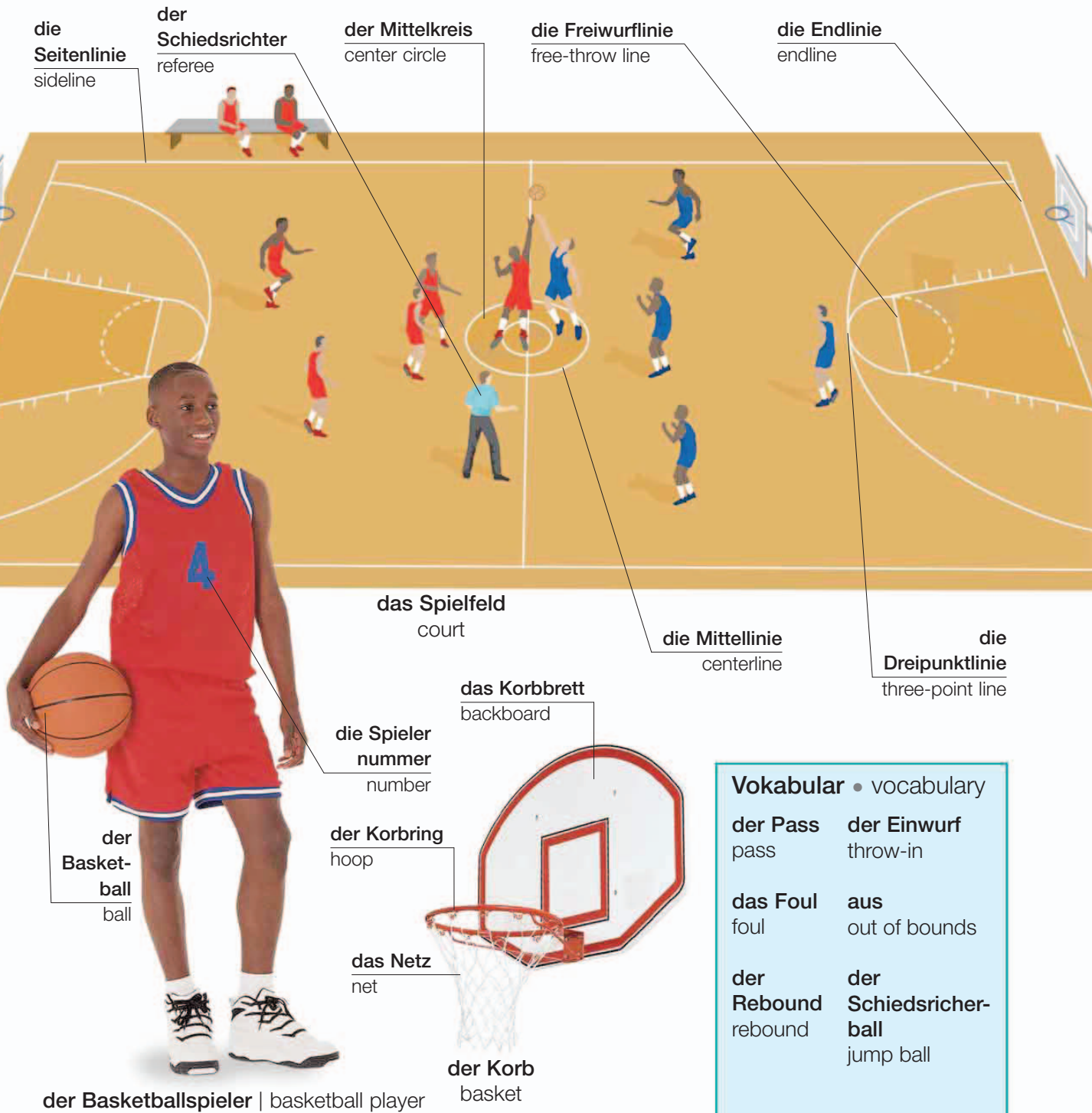

Vokabular • vocabulary

der Pass pass	der Einwurf throw-in
das Foul foul	aus out of bounds
der Rebound rebound	der Schiedsrichterball jump ball

die Aktionen • actions



werfen
throw (v)



fangen
catch (v)



schießen
shoot (v)



springen
jump (v)



einen Dunk spielen
dunk (v)



decken
mark (v)



blocken
block (v)



springen lassen
dribble (v)



der Volleyball • volleyball

blocken
block (v)

das Netz
net

baggern
dig (v)



der Schiedsrichter
referee

der Knieschützer
knee support

das Spielfeld | court

der Baseball • baseball

das Spielfeld • field

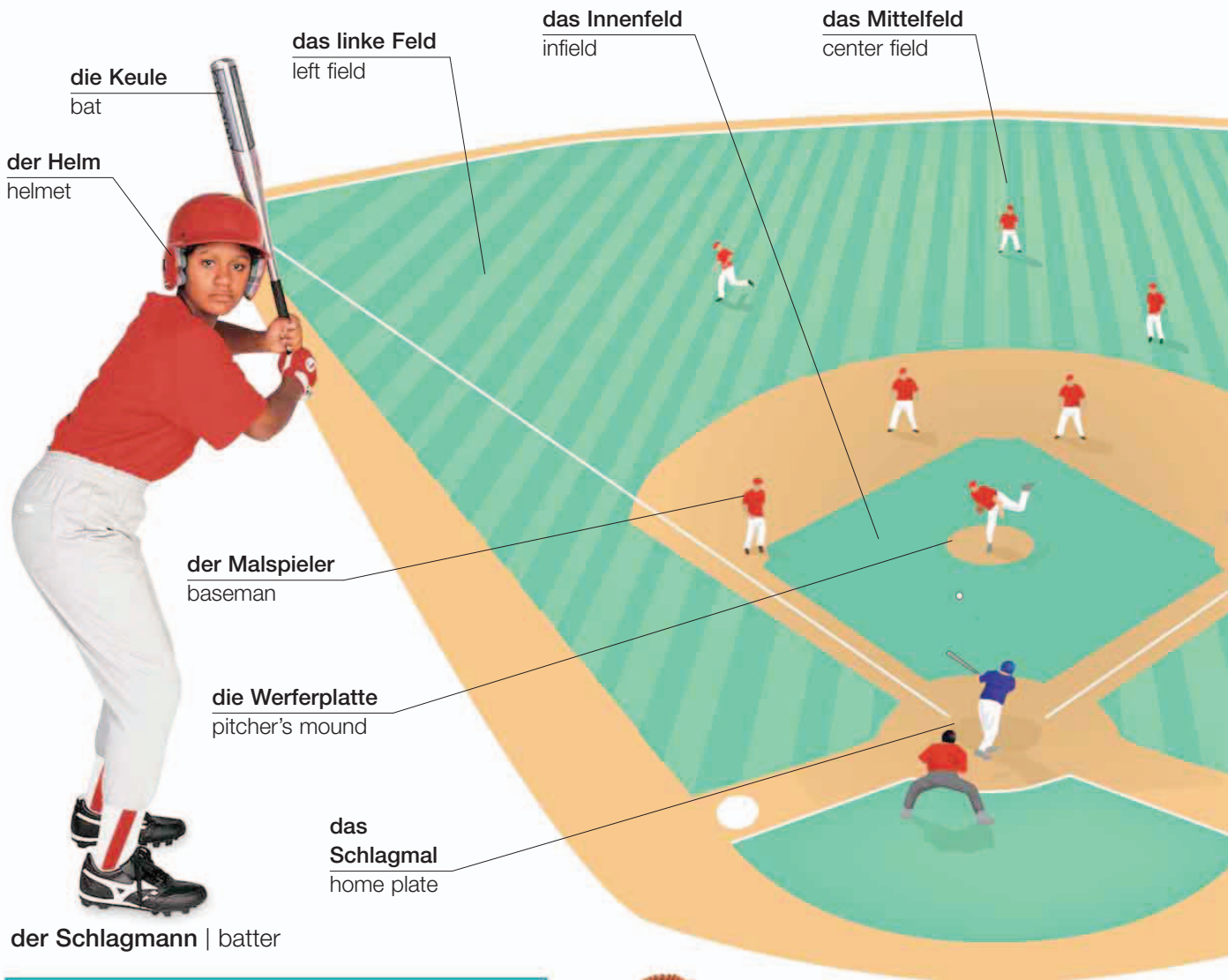

Vokabular • vocabulary

das Inning
inning

aus
out

der Schlagfehler
strike

der Lauf
run

in
Sicherheit
safe

der ungültige Schlag
foul ball



der Handschuh
mitt

der
Baseball
ball



die Schutzmaske
mask

die Aktionen • actions

das Außenfeld
outfield

das rechte Feld
right field

die Foullinie
foul line

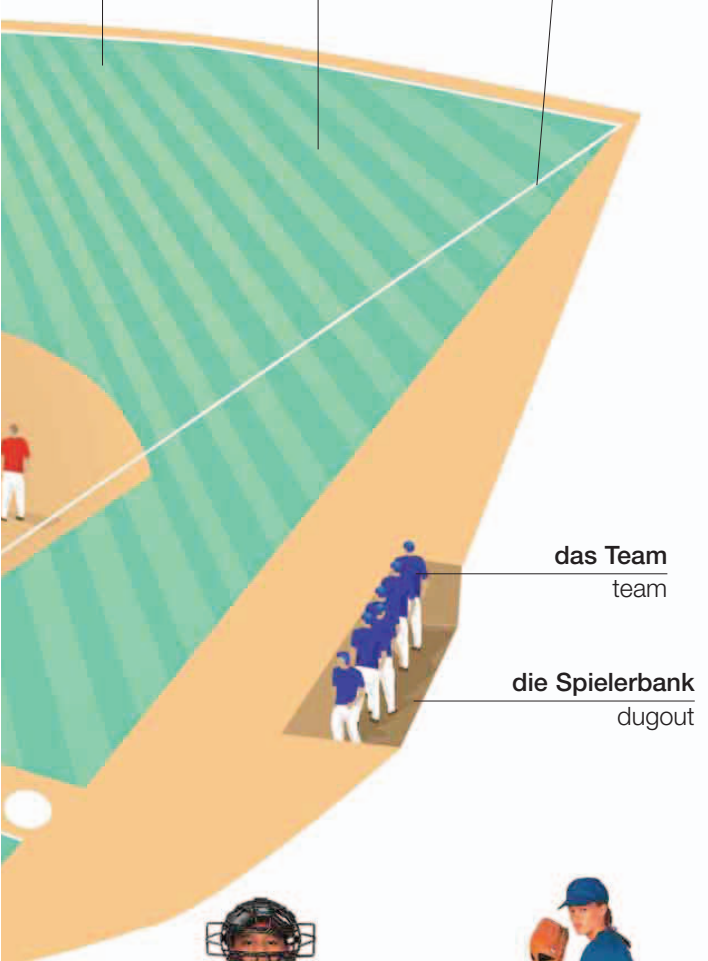

das Team
team

die Spielerbank
dugout



der Fänger
catcher



der Werfer
pitcher



werfen | throw (v)



fangen | catch (v)



rennen
run (v)



als Fänger spielen
field (v)

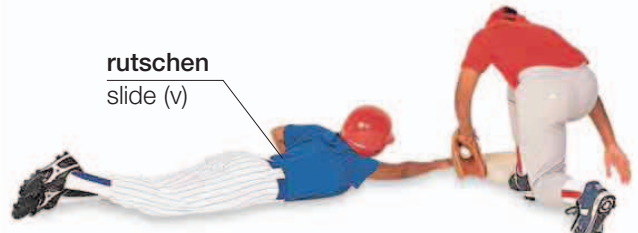

rutschen
slide (v)

hinterherlaufen
tag (v)

werfen
pitch (v)

schlagen
bat (v)

der Schiedsrichter
umpire



spielen | play (v)

das Tennis • tennis

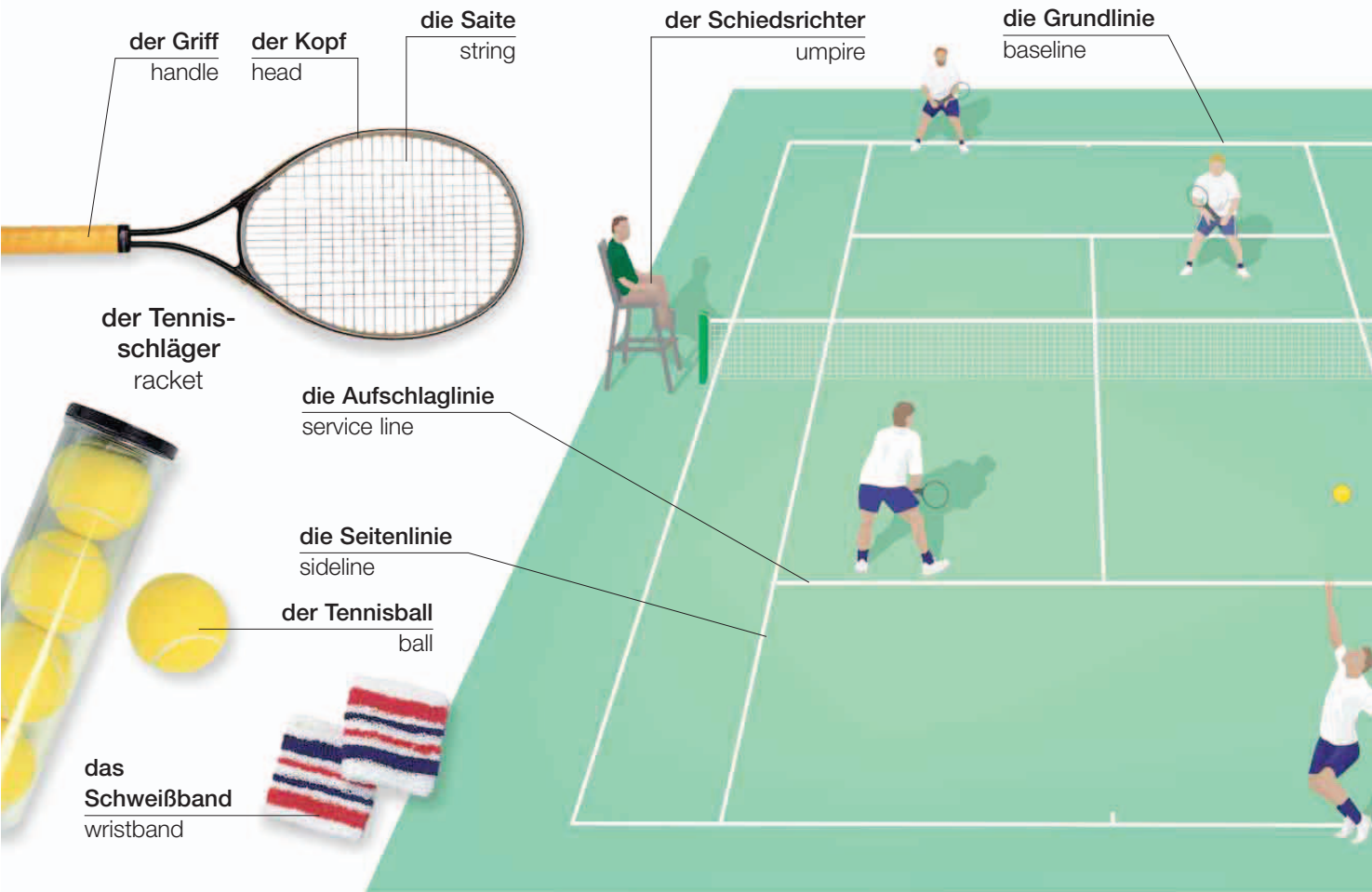

der Tennisplatz | tennis court

Vokabular • vocabulary

das Einzel
singles

der Satz
set

der Einstand
deuce

der Fehler
fault

der Slice
slice

der Spin
spin

das Doppel
doubles

das Match
match

der Vorteil
advantage

das Ass
ace

Netz!
let!

der Linienrichter
linesman

das Spiel
game

der Tiebreak
tiebreak

null
love

der Stoppball
dropshot

der Ballwechsel
rally

die Meisterschaft
championship

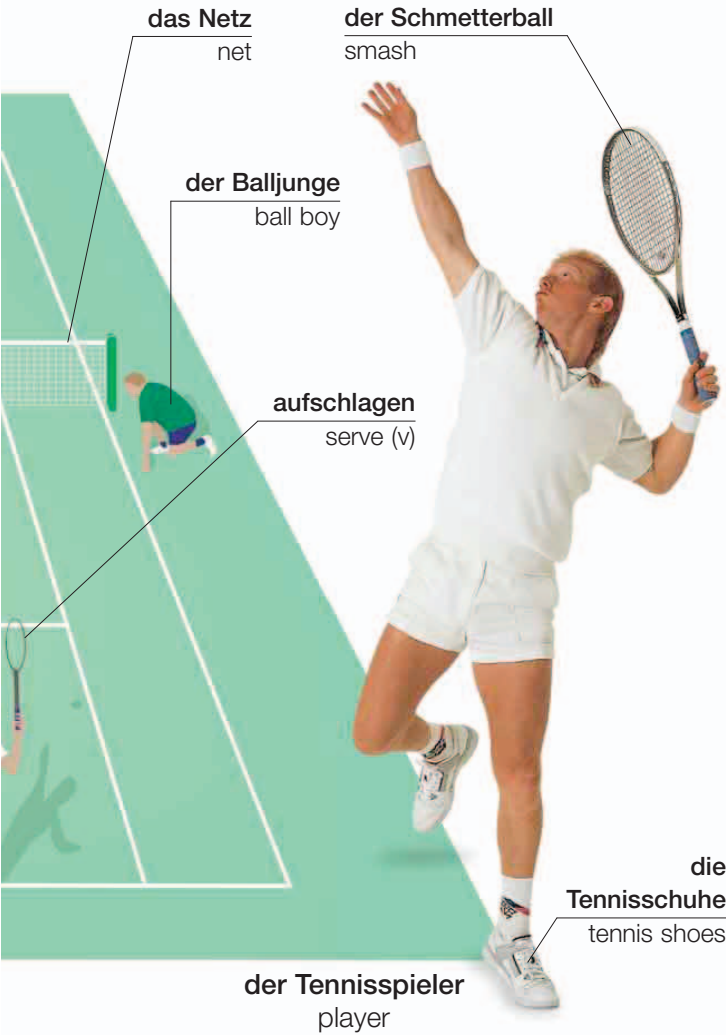

die Schläge • strokes



der Aufschlag
serve



der Volley
volley



der Return
return



der Lob
lob



die Vorhand
forehand



die Rückhand
backhand

die Schlägerspiele • racket games



das Badminton
badminton

der Federball
shuttlecock



das Tischtennis
table tennis

der Tischtennisschläger
paddle



das Squash
squash



das Racquetball
racquetball

das Golf • golf

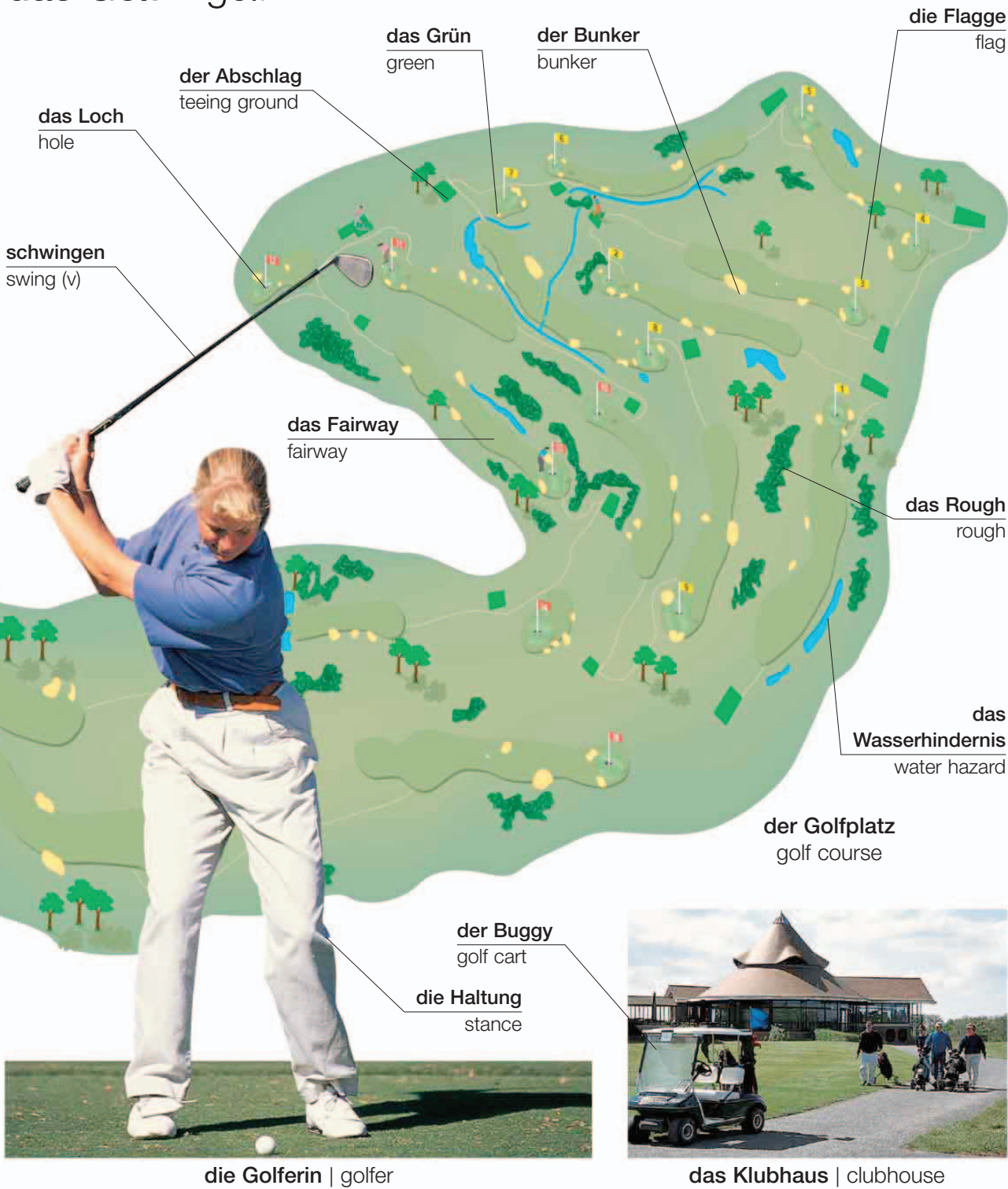

die Ausrüstung • equipment

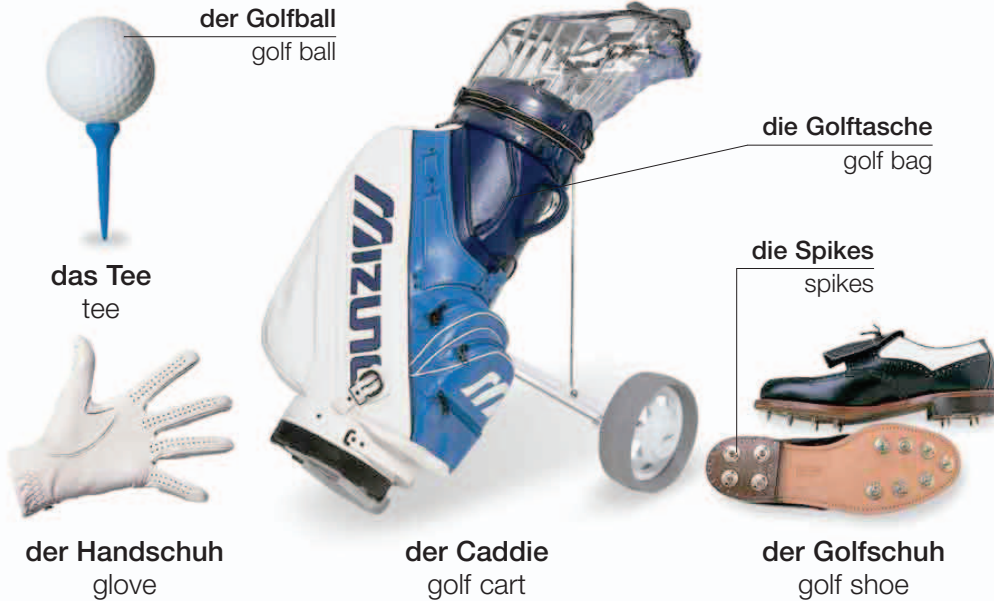

die Golf-
schläger •
golf clubs



das Holz
wood



der Putter
putter



das Eisen
iron



das Wedge
wedge

die Aktionen • actions



Vokabular • vocabulary

das Par par	über Par over par	das Golfturnier tournament	der Caddie caddy	der Schlag stroke	die Spielbahn line of play
unter Par par	das Hole-in-One hole in one	das Handicap handicap	die Zuschauer spectators	der Übungsschwung practice swing	der Durchschwung backswing

die Leichtathletik • track and field

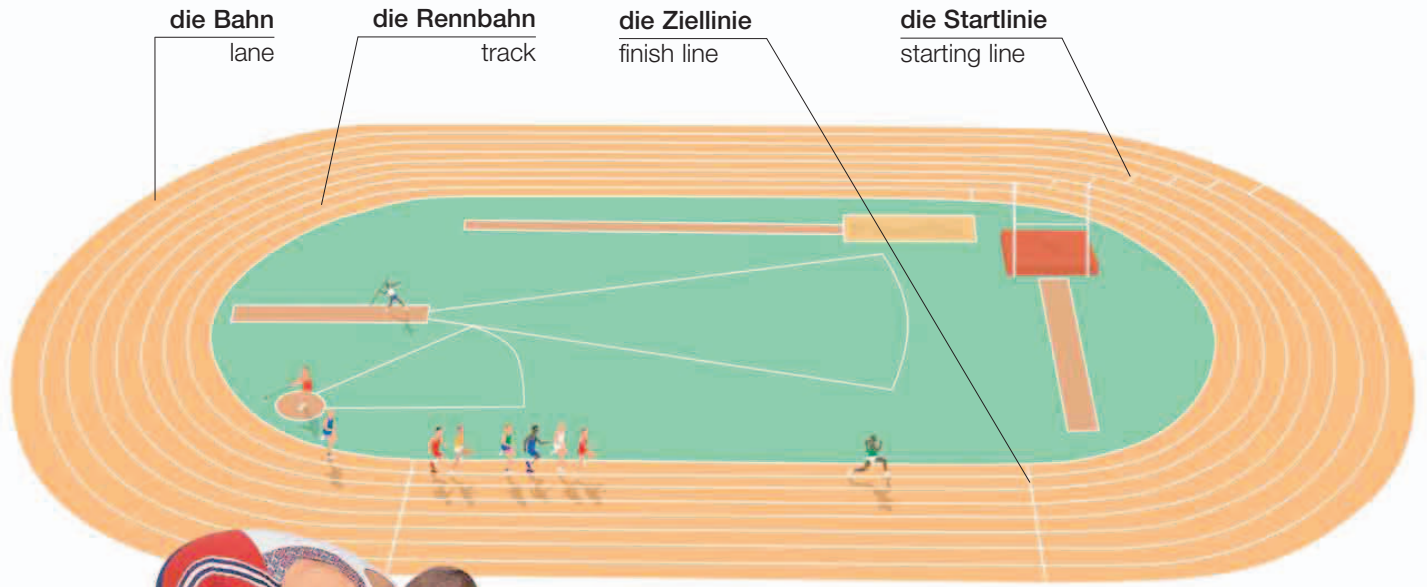

der Startblock
starting blocks

der Sprinter
sprinter



das Diskuswerfen
discus

die Leichtathletin
athlete



das Kugelstoßen
shotput

das Feld
field



das Speerwerfen
javelin

Vokabular • vocabulary

das Rennen
race

der Rekord
record

das Fotofinish
photo finish

der Stabhochsprung
pole vault

die Zeit
time

einen Rekord
brechen
break a record (v)

der Marathon
marathon

die persönliche
Bestleistung
personal best



die Stoppuhr
stopwatch

der Stab
baton



der Staffellauf
relay race

die Latte
crossbar



der Hochsprung
high jump



der Weitsprung
long jump



der Hürdenlauf
hurdles

das Turnen • gymnastics

das Sprungbrett
springboard



der Salto
somersault



die Matte
mat

das Bodenturnen
floor exercises

die Turnerin
gymnast



der Schwebebalken
beam

das Gymnastikband
ribbon



die Bodenakrobatik
tumble



die rhythmische
Gymnastik
rhythmic gymnastics

das Pferd
horse



der Sprung
vault

Vokabular • vocabulary

das Reck
horizontal bar

der Stufenbarren
asymmetric bars

die Ringe
rings

die Medaillen
medals

das Silber
silver

der Barren
parallel bars

das Seitpferd
pommel horse

das Siegerpodium
podium

das Gold
gold

die Bronze
bronze

der Kampfsport • combat sports

der Gegner
opponent

der Kopfschutz
guard

der Handschuh
glove

der Gürtel
belt



das Taekwondo
tae kwon do



das Karate
karate



das Judo
judo



das Aikido
aikido



der Säbel
sword

das Kendo
kendo

die Maske
mask



das Kung-Fu
kung fu



das Kickboxen
kickboxing

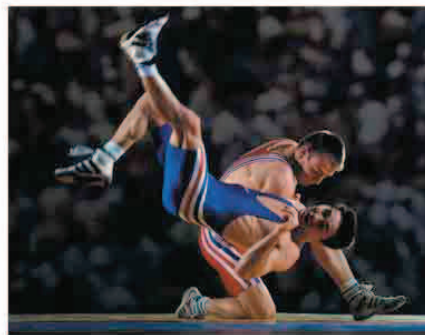

das Ringen
wrestling



das Boxen
boxing

die Techniken • actions



das Fallen
fall



der Griff
hold



der Wurf
throw



das Fesseln
pin



der Seitfußstoß
kick



der Stoß
punch



der Angriff
strike



der Hieb
chop



der Sprung
jump



der Block
block

Vokabular • vocabulary

der Boxing
boxing ring

die Runde
round

die Faust
fist

der schwarze Gürtel
black belt

das Capoeira
capoeira

die Boxhandschuhe
boxing gloves

der Kampf
bout

der Knockout
knockout

die Selbstverteidigung
self-defense

das Sumo
sumo wrestling

der Mundschutz
mouth guard

das Sparring
sparring

der Sandsack
punching bag

die Kampfsportarten
martial arts

das Tai Chi
tai chi

der Schwimmsport • swimming

die Ausrüstung • equipment



der Schwimmflügel
armband



die Schwimmbrille
goggles

die Nasenklemme
nose clip



das Schwimmfloß
kickboard



der Badeanzug
swimsuit

die Bahn
lane

das Wasser
water

der Startblock
starting block



das Schwimmbecken
swimming pool

die Badekappe
cap



die Badehose
trunks

der Schwimmer | swimmer

das Sprungbrett
springboard

der Springer
diver



springen | dive (v)



schwimmen | swim (v)



die Kehre | turn

die Schwimmstile • styles



das Kraulen
front crawl



das Brustschwimmen
breaststroke



das Rückenschwimmen | backstroke

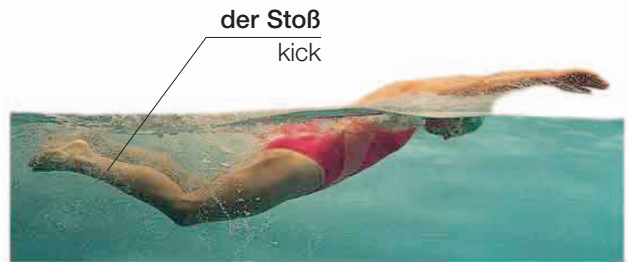

der Butterfly | butterfly

das Tauchen • scuba diving

der Taucheranzug
wetsuit

die Schwimmflosse
flipper

der Bleigürtel
weight belt



die Druckluftflasche
air cylinder

die Tauchermaske
mask

der Lungenautomat
regulator

der Schnorchel
snorkel

Vokabular • vocabulary

der Sprung dive	Wasser treten tread water (v)	das tiefe Ende deep end	der Wasserball water polo	das flache Ende shallow end	der Krampf cramp
der Turmsprung high dive	der Startsprung racing dive	die Schließfächer lockers	der Bademeister lifeguard	das Synchronschwimmen synchronized swimming	ertrinken drown (v)

der Segelsport • sailing



der Kompass
compass



der Anker
anchor

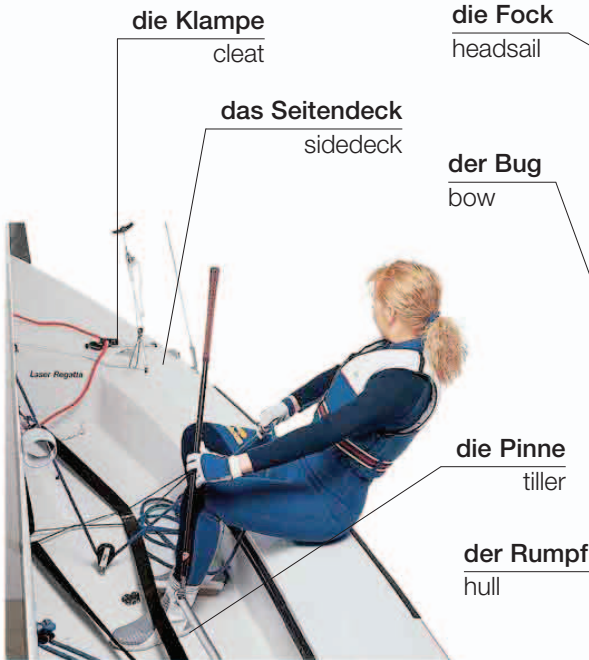

navigieren | navigate (v)



die Segeljacht | yacht

die Sicherheit • safety



die Leuchtrakete
flare



der Rettungsring
life preserver



die Schwimmweste
life jacket



das Rettungsboot
life raft

der Wassersport • watersports



der Ruderer
rower

das Ruder
oar

rudern | row (v)



das Kajak
kayak

das Paddel
paddle

der Kanusport
canoeing



das Segel
sail

der Windsurfer
windsurfer

das
Surfbrett
board

die Fußschlaufe
footstrap

das Windsurfing | windsurfing



das Surfbrett
surfboard

das Wellenreiten
surfing

der Wasserski
ski



das Wasserski
waterskiing



der Schnellbootsport
speed-boating



das Rafting
rafting



der Wassermotorsport
jet skiing

Vokabular • vocabulary

der Surfer
surfer

die Crew
crew

der Wind
wind

die Brandung
surf

die Schot
sheet

das Schwert
centerboard

der
Wasserskifahrer
waterskier

aufkreuzen
tack (v)

die Welle
wave

das Wildwasser
rapids

das Ruder
rudder

kentern
capsize (v)

der Reitsport • horse riding

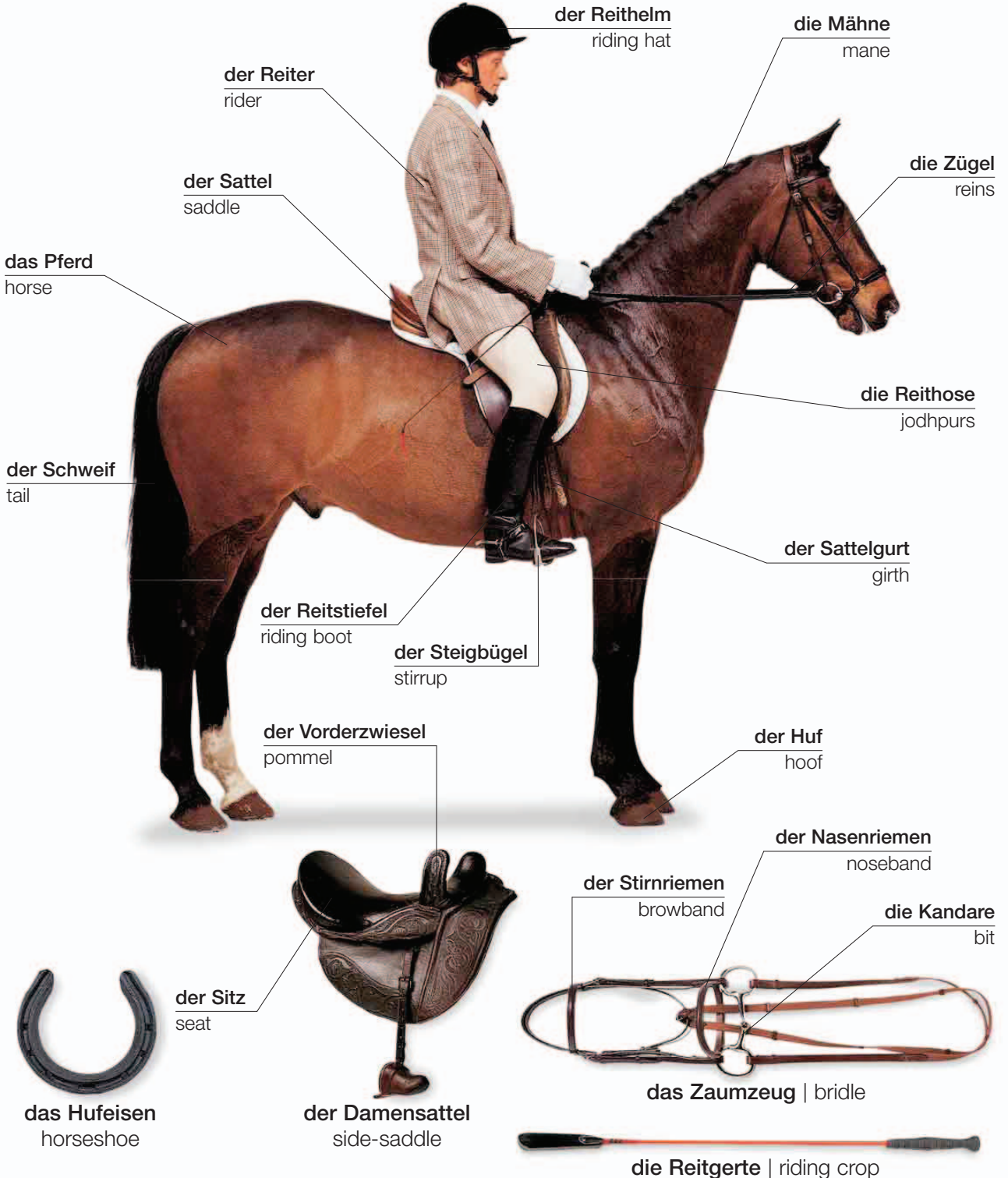

die Veranstaltungen • events

das Rennpferd
racehorse



das Pferderennen
horse race

das Hindernis
fence



das Jagdrennen
steeplechase



das Trabrennen
harness race



das Rodeo
rodeo



das Springreiten
showjumping



das Zweispännerrennen
carriage race



das Trekking
trail riding



das Dressurreiten
dressage



das Polo
polo

Vokabular • vocabulary

der Schritt
walk

der Kanter
canter

der Sprung
jump

das Halfter
halter

die Koppel
paddock

das Flachrennen
flat race

der Trab
trot

der Galopp
gallop

der Stallbursche
groom

der Pferdestall
stable

der
Turnierplatz
arena

die Rennbahn
racecourse

der Angelsport • fishing



das Gewicht | sinker

der Widerhaken
barb

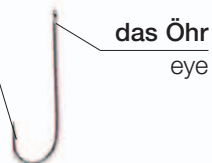

der Angelhaken
fishhook



der Köder | bait



die Pose
float



der Köderhaken
lure



die Fliege
fly



der Kescher
landing net



der Spinnerkasten
tackle box



der Setzkescher
keep net

die Schnur
line

die Angelrute
fishing rod

die Rolle
reel

die
Watstiefel
waders

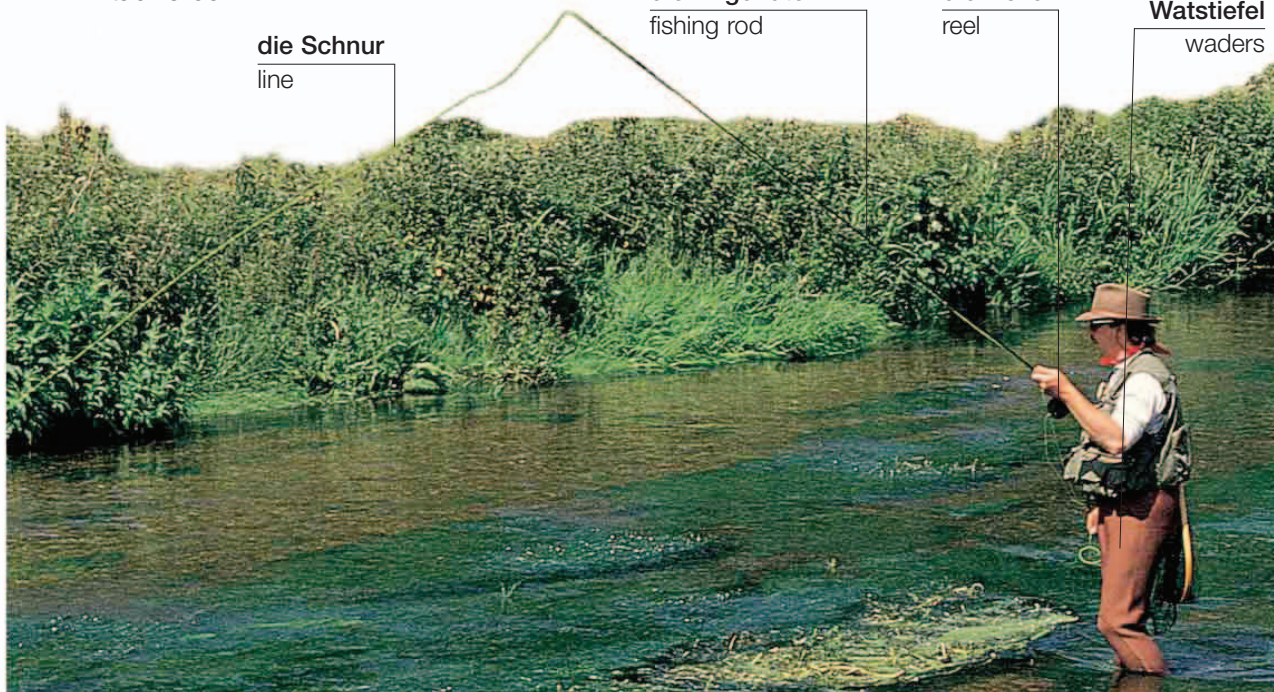

der Angler | angler

die Fischfangarten • types of fishing



das Süßwasserangeln
freshwater fishing



das Fliegenangeln
fly fishing

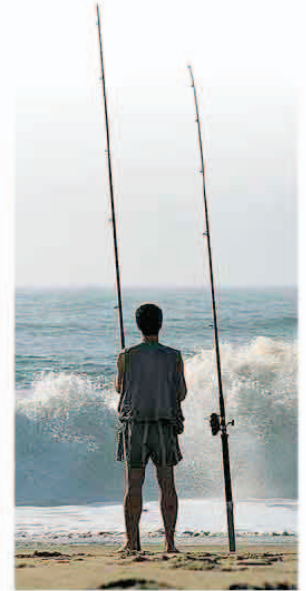

das Brandungsangeln
surfcasting



das Sportangeln
sport fishing



die Hochseefischerei
deep sea fishing

die Aktivitäten • activities

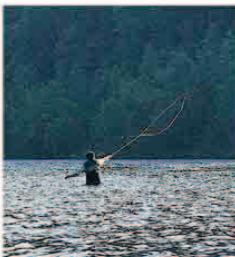

auswerfen
cast (v)

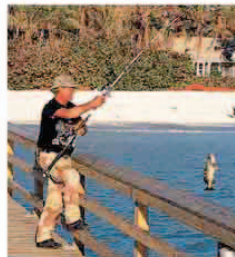

fangen
catch (v)



einholen
reel in (v)



mit dem Netz fangen
net (v)



loslassen
release (v)

Vokabular • vocabulary

ködern
bait (v)

die Angelgeräte
tackle

die Regenhaut
waterproofs

der Angelschein
fishing permit

der Fischkorb
creel

anbeißen
bite (v)

die Rolle
spool

die Stake
pole

die Seefischerei
marine fishing

das Speerfischen
spearfishing

der Skisport • skiing

der Skihang
ski slope

der Sessellift
chairlift

der Kabinenlift
cable car



der Handschuh
glove

der Skistock
ski pole

die Skipiste
ski run

die
Sicherheitssperre
safety barrier

die Spitze
tip

die Kante
edge

der Ski
ski

die Skijacke
ski jacket

die Skiläuferin
skier

der Skistiefel
ski boot

die Disziplinen • events



der Abfahrtslauf
downhill skiing



das Tor
gate

der Slalom
slalom



der Skisprung
ski jump



der Langlauf
cross-country skiing

der Wintersport • winter sports



das Eisklettern
ice climbing



das Eislaufen
ice-skating



der Eiskunstlauf
figure skating

die Skibrille
goggles

der Schlittschuh
skate



das Snowboarding
snowboarding

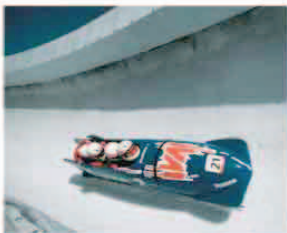

der Bobsport
bobsled



das Rennrodeln
luge



das Schneemobil
snowmobile



das Schlittenfahren
sledding

Vokabular • vocabulary

die alpine Kombination
alpine skiing

das Hundeschlittenfahren
dog-sledding

der Riesenslalom
giant slalom

das Eisschnelllauf
speed skating

abseits der Piste
off-piste

das Biathlon
biathlon

das Curling
curling

die Lawine
avalanche

die anderen Sportarten • other sports

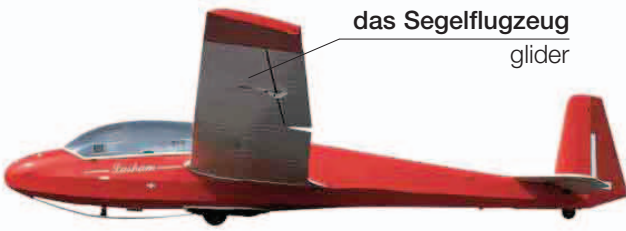

das Segelflugzeug
glider

der Drachen
hang-glider



das Drachenfliegen
hang-glider

das Segelfliegen
gliding

der Fallschirm
parachute



das Seil
rope

das Klettern
rock-climbing



das Fallschirmspringen
parachuting

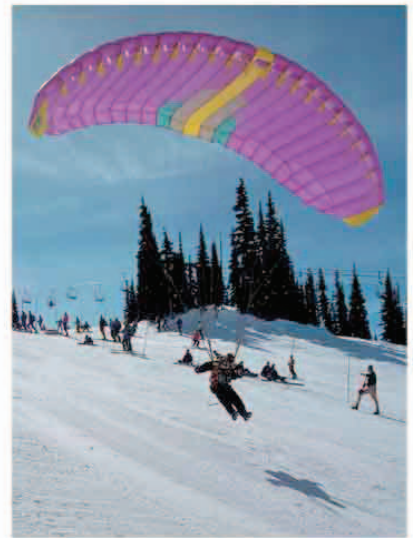

das Gleitschirmfliegen
paragliding



das Fallschirmspringen
skydiving



das Abseilen
rappelling



das Bungeejumping
bungee jumping



das Rallyefahren
rally driving



der Rennsport
auto racing



das Motocross
motocross



das Motorradrennen
motorcycle racing

der Rennfahrer
racing driver

das Skateboard
skateboard



das Skateboard-fahren
skateboarding



das Inlineskaten
inline skating

der Lacrosseschläger
stick



das Lacrosse
lacrosse

das Florett
foil

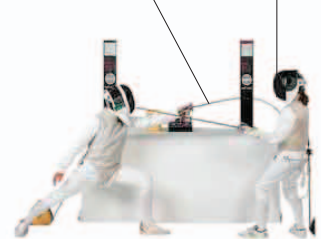

das Fechten
fencing

die Maske
mask

der Kegel
pin

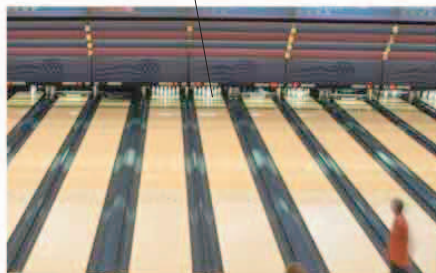

das Bowling
bowling

der Pfeil
arrow

der Köcher
quiver



das Bogenschießen
archery

die Zielscheibe
target



das Scheibenschießen
target shooting

der Bogen
bow

die Bowlingkugel
bowling ball



das Poolbillard
pool



das Snooker
snooker

die Fitness • fitness

das Trainingsrad
exercise bike

die Gewichte
free weights

die Stange
bar

das Fitnessgerät
gym machine

die Bank
bench



die Rudermaschine
rowing machine

das Fitnesscenter | gym



das Laufband
treadmill



die Langlaufmaschine
cross-trainer



die private Fitness-
trainerin
personal trainer



die Tretmaschine
step machine

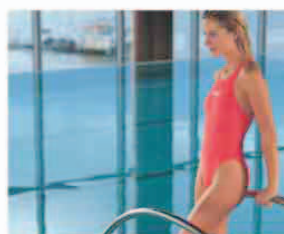

das Schwimmbecken
swimming pool



die Sauna
sauna

die Übungen • exercises



das Strecken
stretch



der Ausfall
lunge



die Strumpfhose
tights

der Liegestütz
pushup



die Kniebeuge
squat



das Rumpfheben
situp

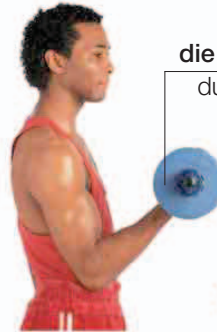

die Hantel
dumbbell

die Bizepsübung
biceps curl



der Beinstütz
leg press



die Brustübung
chest press



Trainings-
schuhe
athletic
shoes

die Gewicht-
hantel
weight bar

das Krafttraining
weight training



das Jogging
jogging



das Pilates
pilates

Vokabular • vocabulary

trainieren
train (v)

beugen
flex (v)

ausstrecken
extend (v)

die Boxgymnastik
boxercise

das Seilspringen
jumping rope

sich
aufwärmen
warm up (v)

auf der Stelle
joggen
jog in place (v)

hochziehen
pull up (v)

das Zirkeltraining
circuit training



die Freizeit
leisure

das Theater • theater



der Vorhang
curtain

die Kulisse
wings

das Bühnenbild
set

das Publikum
audience

das Orchester
orchestra

die Bühne | stage

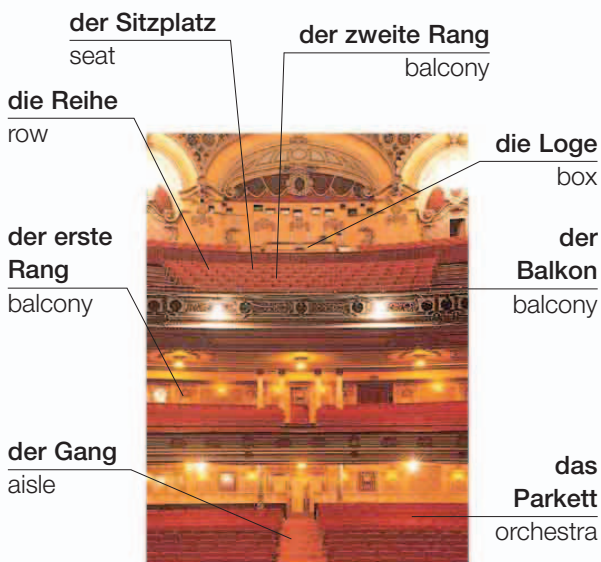

der Sitzplatz
seat

der zweite Rang
balcony

die Reihe
row

die Loge
box

der erste Rang
balcony

der Balkon
balcony

der Gang
aisle

das Parkett
orchestra

die Bestuhlung | seating

Vokabular • vocabulary

das Theaterstück
play

der Regisseur
director

die Premiere
first night

die Besetzung
cast

der Prospekt
backdrop

die Pause
intermission

der Schauspieler
actor

das Rollenheft
script

das Programm
program

die Schauspielerin
actress

der Regisseur
producer

der Orchestergraben
orchestra pit



das Konzert
concert



das Musical
musical

das Theaterkostüm
costume



das Ballett
ballet



die Oper
opera

Vokabular • vocabulary

der Platzanweiser
usher

die klassische Musik
classical music

die Noten
musical score

die Tonspur
soundtrack

applaudieren
applaud (v)

die Zugabe
encore

Ich möchte zwei Karten für die Aufführung heute Abend.
I'd like two tickets for tonight's performance.

Um wieviel Uhr beginnt die Aufführung?
What time does it start?

das Kino • cinema

das Popcorn
popcorn

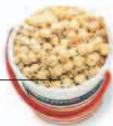

das Foyer
lobby

die Kasse
box office

das Plakat
poster



der Kinosaal
movie theater



die Leinwand
screen

Vokabular • vocabulary

die Komödie
comedy

der Thriller
thriller

der Horrorfilm
horror movie

der Western
western

der Liebesfilm
romance

der Science-Fiction-Film
science fiction movie

der Abenteuerfilm
adventure

der Zeichentrickfilm
animated film

das Orchester • orchestra

die Saiteninstrumente • strings



das Klavier | piano

die Noten
score

der
Bassschlüssel
bass clef

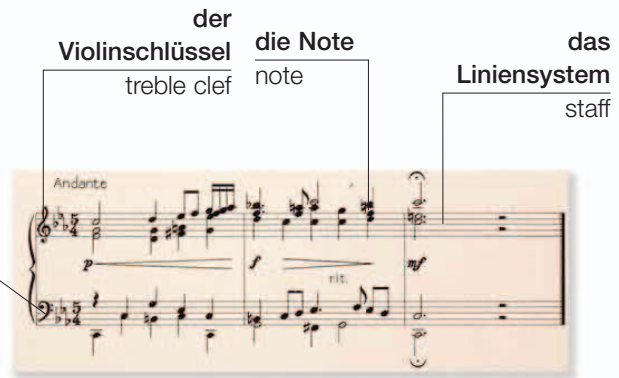

die Notation | notation

Vokabular • vocabulary

die Ouvertüre overture	die Sonate sonata	die Tonhöhe pitch	das Kreuz sharp	der Taktstrich bar	die Tonleiter scale
die Symphonie symphony	die Musikinstrumente instruments	das Pausenzeichen rest	das B flat	das Auflösungszeichen natural	der Taktstock baton

die Holzblasinstrumente • woodwind



die Pikkoloflöte
piccolo



die Querflöte
flute



die Oboe
oboe



das Englischhorn
cor anglais



das Saxophon
saxophone



die Klarinette
clarinet



die Bassklarinetten
bass clarinet



das Fagott
bassoon



das Kontrafagott
double bassoon

die Schlaginstrumente • percussion



die Kesselpauke
kettledrum



der Gong
gong

das Vibraphon
vibraphone



das Fußpedal
foot pedal



die Bongos
bongos



die kleine
Trommel
snare drum



das Becken
cymbals



das
Tamburin
tambourine



der Triangel
triangle



die Maracas
maracas

die Blechblasinstrumente • brass



die Trompete
trumpet



die Posaune
trombone



das Horn
French horn



die Tuba
tuba

das Konzert • concert



das Rockkonzert | rock concert

die Instrumente • instruments

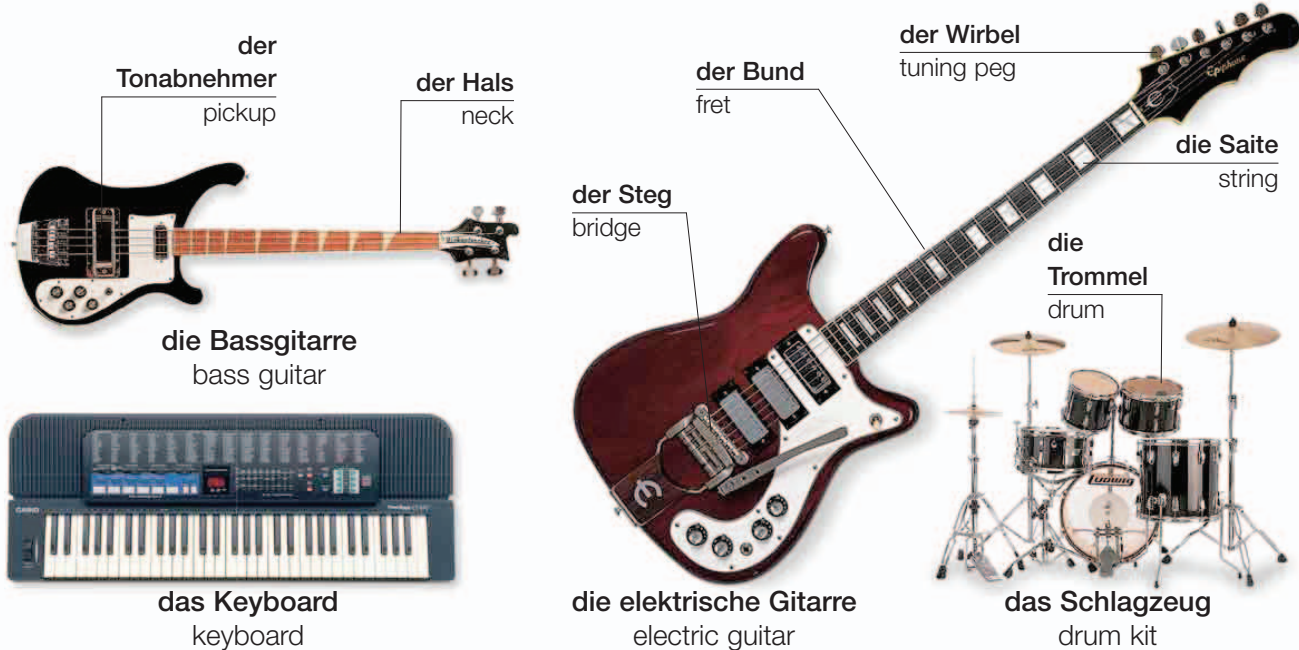

die Musikstile • musical styles



der Jazz
jazz



der Blues
blues



die Punkmusik
punk



der Folk
folk music



der Pop
pop



die Tanzmusik
dance



der Rap
rap



das Heavymetal
heavy metal



die klassische Musik
classical music

Vokabular • vocabulary

das Lied
song

der Text
lyrics

die Melodie
melody

der Beat
beat

der Reggae
reggae

die Countrymusic
country

die Besichtigungstour • sightseeing



der Tourist
tourist

die Touristenattraktion | tourist attraction

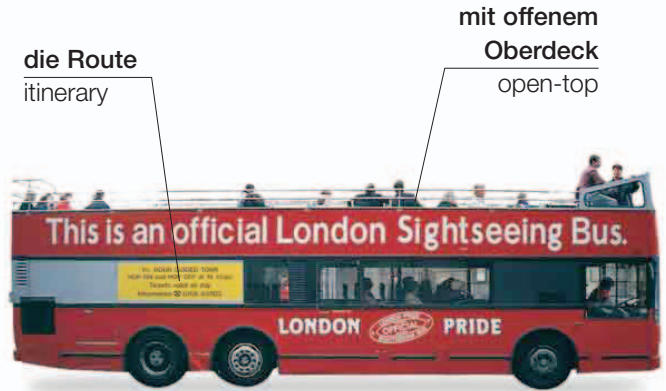

die Route
itinerary

mit offenem
Oberdeck
open-top

der Stadtrundfahrtbus | tour bus



die Führung
guided tour

die
Fremdenführerin
tour guide



die Andenken
souvenirs

die Figur
statuette

Vokabular • vocabulary

geöffnet
open

der Film
film

der Camcorder
camcorder

links
left

Wo ist...?
Where is...?

geschlossen
closed

die Batterien
batteries

die Kamera
camera

rechts
right

Ich habe mich verlaufen.
I'm lost.

das
Eintrittsgeld
admission
charge

der
Reiseführer
guidebook

die Richtungs-
angaben
directions

geradeaus
straight
ahead

Können Sie mir sagen, wie
ich nach... komme?
Can you tell me the way to....?

die Sehenswürdigkeiten • attractions

das
Gemälde
painting

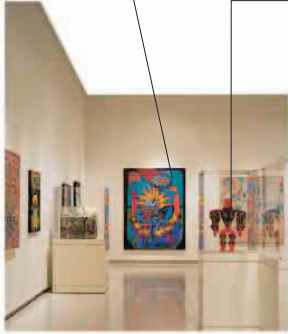

die Kunstgalerie
art gallery

das
Ausstellungs-
stück
exhibit



das Monument
monument

die
Ausstellung
exhibition



das Museum
museum

die berühmte
Ruine
famous ruin



das historische
Gebäude
historic building



das Kasino
casino



der Park
gardens



der Nationalpark
national park

die Information • information

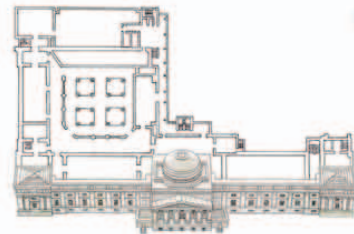

der Grundriss
floor plan



der Stadtplan
map

die Zeiten
times



der Fahrplan
schedule



die
Touristeninformation
tourist information

die Aktivitäten im Freien • outdoor activities

der Fußweg
footpath

die Sonnenuhr
sundial

das Café
café

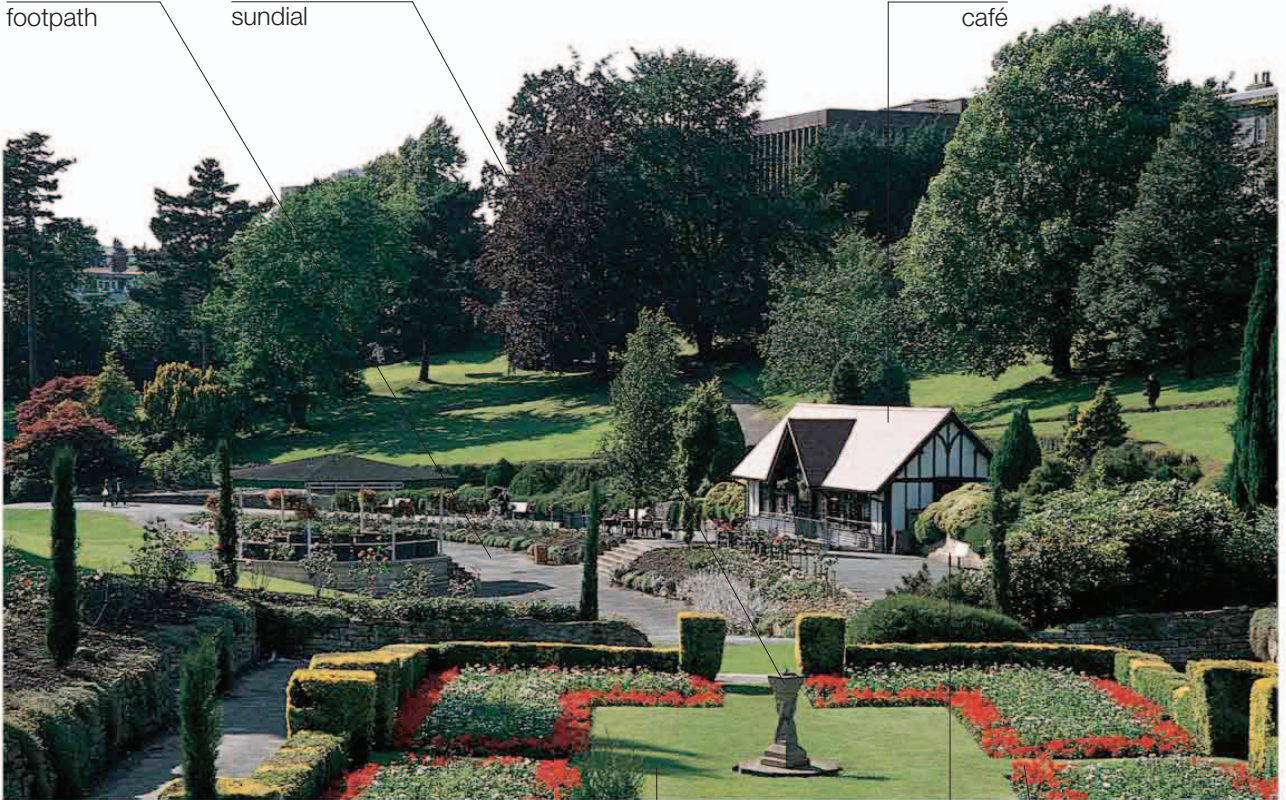

der Park | park

das Gras
grass

die Bank
bench

die Gartenanlagen
formal gardens

die Berg-und-
Talbahnen
roller coaster



der Jahrmarkt
fairground



der Vergnügungspark
theme park



der Safaripark
safari park



der Zoo
zoo

die Aktivitäten • activities



das Radfahren
cycling



das Jogging
jogging



das Skateboardfahren
skateboarding



das Inlinerfahren
rollerblading

der Reitweg
bridle path



das Vogelbeobachten
bird-watching



das Reiten
horseback riding



das Wandern
hiking

der Picknickkorb
hamper



das Picknick
picnic

der Spielplatz • playground



der Sandkasten
sandbox



das Planschbecken
wading pool



die Schaukel
swings



die Wippe | seesaw



die Rutsche
slide



das Klettergerüst
climbing frame

der Strand • beach

das
Hotel
hotel

der
Sonnenschirm
beach umbrella

das
Strandhäuschen
beach hut

der Sand
sand

die Welle
wave

das Meer
sea



die Strandtasche
beach bag

der Bikini
bikini



sonnenbaden | sunbathe (v)



der
Rettungsschwimmer
lifeguard

der Rettungsturm
lifeguard tower

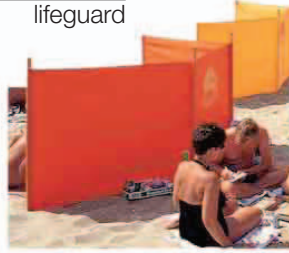

der Windschutz
windbreak



die Promenade
boardwalk



der Liegestuhl
deck chair



die Sonnenbrille
sunglasses



der Sonnenhut
sun hat



die Sonnenmilch
suntan lotion



der Sonnenblock
sunblock



der Wasserball
beach ball



der Schwimmreifen
inflatable ring

der Badeanzug
swimsuit

die Schaufel
shovel

der Eimer
pail

die Sandburg
sandcastle

die Muschel
shell



das Strandtuch
beach towel



das Camping • camping



Vokabular • vocabulary

zelten
camp (v)

der Zeltplatz
site

die Picknickbank
picnic bench

die Holzkohle
charcoal

Zeltplätze frei
sites available

die Zeltstange
tent pole

die Hängematte
hammock

der Feueranzünder
firelighter

voll
full

das Faltbett
camp bed

das Wohnmobil
camper van

ein Feuer machen
light a fire (v)

die Campingplatzverwaltung
site manager's office

ein Zelt aufschlagen
pitch a tent (v)

der Anhänger
trailer

das Lagerfeuer
campfire



der **Insektenspray**
insect repellent



die **Taschenlampe**
flashlight

das **Moskitonetz**
mosquito net



die **Thermowäsche**
thermals



der **Schlafsack**
sleeping bag



die **Wanderschuhe**
walking boots



die **Regenhaut**
rain gear



der **Gasbrenner**
camping stove



der **Grill**
barbecue grill

die **Schlafmatte**
sleeping mat



die **Luftmatratze** | air mattress

die Privatunterhaltung • home entertainment



das Digitalradio
digital radio



der iPod®
iPod

die DVD-Platte
DVD



der DVD-Spieler
DVD player

der Plattenspieler
record player

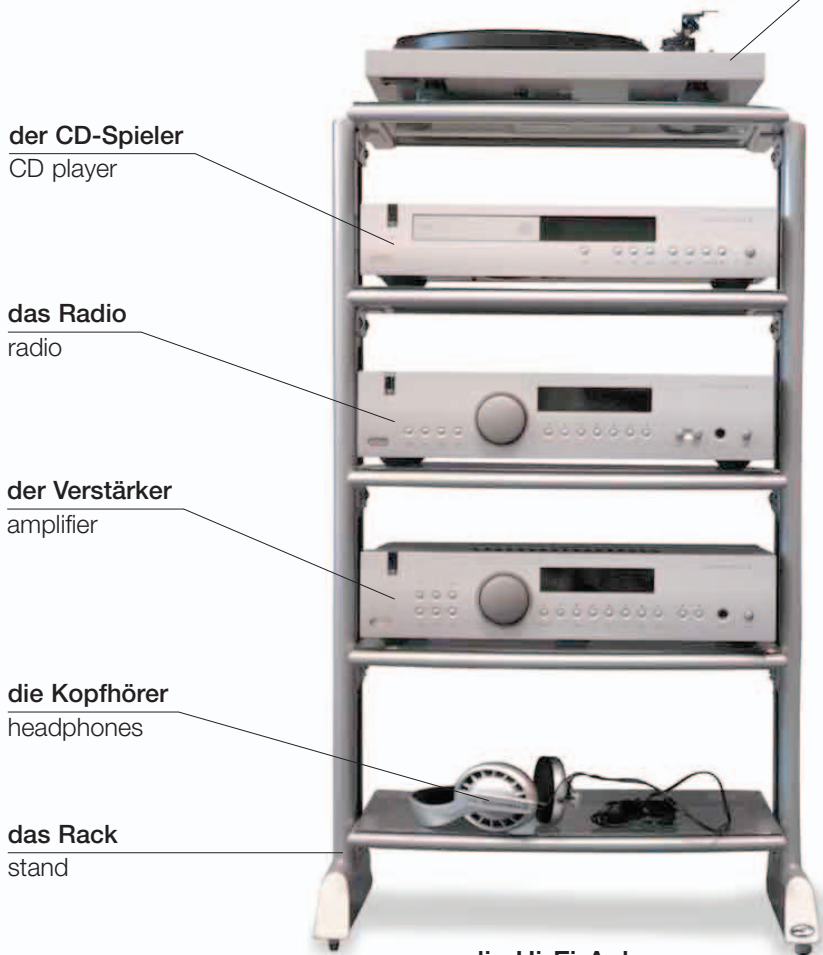

der CD-Spieler
CD player

das Radio
radio

der Verstärker
amplifier

die Kopfhörer
headphones

das Rack
stand

die Hi-Fi-Anlage
stereo system



die Box
speaker

der Ständer
speaker stand



die Digitale Box
DTV converter box



der Camcorder
camcorder



die Satellitenschüssel
satellite dish



der Flachbildfernseher
flatscreen TV



das Pult
console

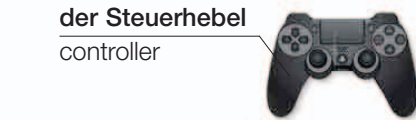

der Steuerhebel
controller

das Videospiel | video game



der Vorlauf
fast-forward

die Pause
pause

die Aufnahme
record

die Lautstärke
volume

der Rücklauf
rewind

das Abspielen
play

der Stop
stop

die Fernbedienung
remote control

Vokabular • vocabulary

die CD-Platte
CD

die Werbung
advertisement

das Kabelfernsehen
cable television

digital
digital

stereo
stereo

die Kassette
cassette tape

der Pay-Kanal
pay-per-view
channel

das Programm
program

fernsehen
watch television (v)

das Radio
einstellen
tune the radio (v)

der
Kassettenrekorder
cassette player

das Streaming
streaming

den Kanal
wechseln
change channels (v)

den Fernseher
einschalten
turn on the
television (v)

den Fernseher
abschalten
turn off the
television (v)

der Spielfilm
feature film

WLAN
wifi

hochauflösend
high-definition

die Fotografie • photography

der Auslöser
shutter release

der Blendenregler
aperture dial

die Linse
lens



der Filter
filter



die Schutzkappe
lens cap

die Spiegelreflexkamera | SLR camera



der Elektronenblitz
flash gun



der Belichtungsmesser
light meter



das Zoom
zoom lens



das Stativ
tripod

die Fotoapparattypen • types of camera



die Polaroidkamera
polaroid camera



die Kamera für APS-Film
APS camera

der Blitz
flash



das Kamera-Handy
camera phone



die Einwegkamera
disposable camera

fotografieren • photograph (v)

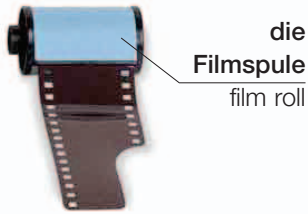

der Film
film



einstellen
focus (v)



entwickeln
develop (v)



das Negativ
negative

quer
landscape



das Foto | photograph

hoch
portrait



das Fotoalbum
photo album



der Fotorahmen
picture frame

die Probleme • problems



unterbelichtet
underexposed



überbelichtet
overexposed



unscharf
out of focus



die Rotfärbung der Augen
red eye

Vokabular • vocabulary

der Bildsucher
viewfinder

der Abzug
print

die Kameratasche
camera case

matt
mat

die Belichtung
exposure

hochglanz
gloss

die Dunkelkammer
darkroom

die Vergrößerung
enlargement

Könnten Sie diesen Film entwickeln lassen?
I'd like this film processed

die Spiele • games

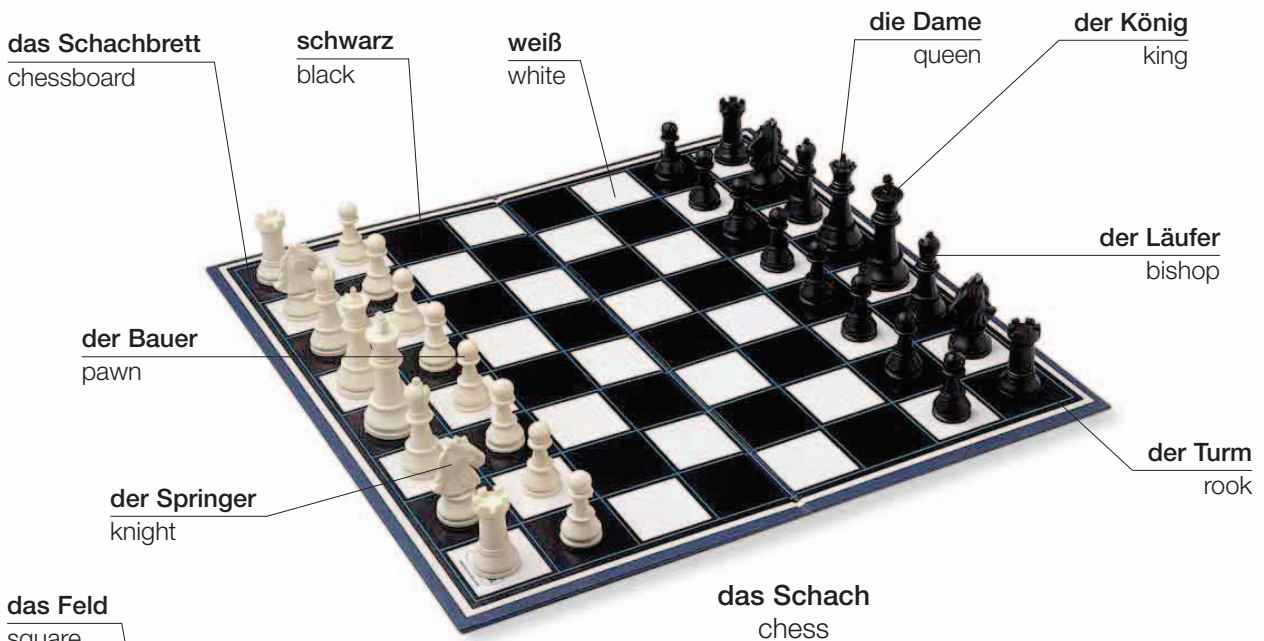

das Damespiel
checkers

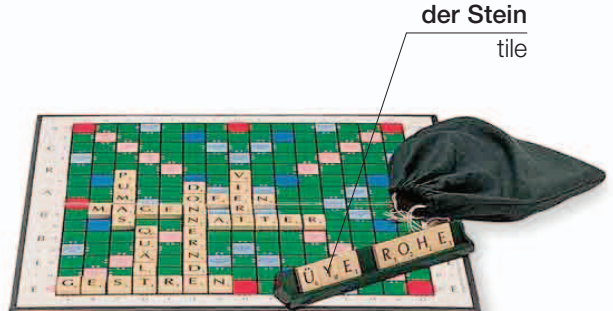

das Scrabble
Scrabble

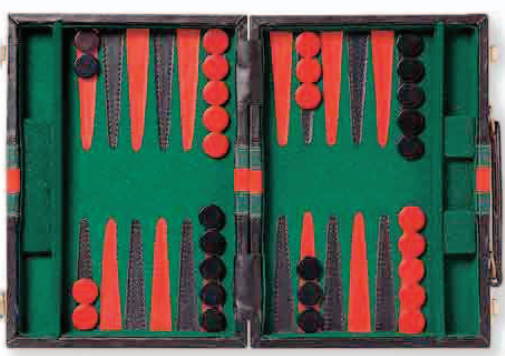

die Brettspiele | board games



das Briefmarkensammeln
stamp collecting



das Puzzle
jigsaw puzzle



das Domino
dominoes

die Dartscheibe
dartboard

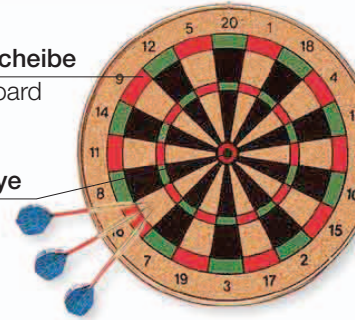

das Bull's Eye
bullseye

das Darts
darts

der Joker
joker

der Bube
jack

die Dame
queen

der König
king

das Ass
ace



die Karten
cards

das Karo
diamond

das Pik
spade

das Herz
heart

das Kreuz
club



mischen | shuffle (v)



geben | deal (v)

Vokabular • vocabulary

der Zug
move

gewinnen
win (v)

der Verlierer
loser

das Bridge
bridge

der Punkt
point

Wer ist dran?
Whose turn is it?

spielen
play (v)

der Gewinner
winner

das Spiel
game

das Poker
poker

die Farbe
suit

Du bist dran.
It's your move.

der Spieler
player

verlieren
lose (v)

die Wette
bet

das Kartenspiel
deck of cards

das Spielergebnis
score

Würfle.
Roll the dice.

das Kunsthandwerk 1 • arts and crafts 1

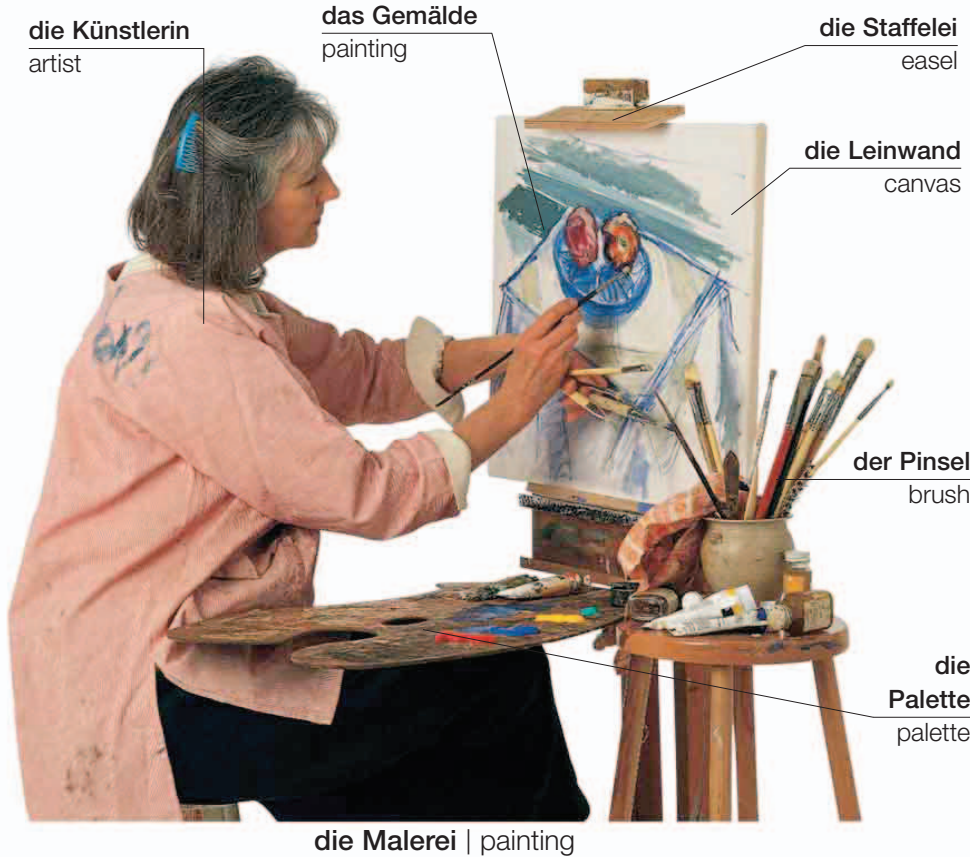

die Farben • paints



die Ölfarben
oil paints



die Aquarellfarbe
watercolor paint



die Pastellstifte
pastels



die Acrylfarbe
acrylic paint



die Plakatfarbe
poster paint

die Farben • colours



rot
red



blau
blue



gelb
yellow



grün
green



orange
orange



lila
purple

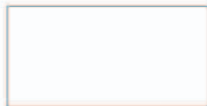

weiß
white



schwarz
black

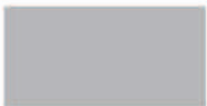

grau
gray



rosa
pink



braun
brown



indigoblau
indigo

andere Kunstfertigkeiten • other crafts

der Skizzenblock
sketch pad

die Skizze
sketch

die Druckfarbe
ink

der Bleistift
pencil

der Kohlestift
charcoal

das Zeichnen | drawing

das Drucken
printing

das Gravieren
engraving

der Stein
stone

der Schlegel
mallet

der Meißel
chisel

das Holz
wood

die Bildhauerei
sculpting

die Holzarbeit
woodworking

das Modellierholz
modeling tool

die Drehscheibe
potter's wheel

der Ton
clay

die Töpferei
pottery

der Klebstoff
glue

die Pappe
cardboard

die Collage | collage

die Juwelierarbeit
jewelry-making

das Papiermâché
papier-mâché

das Origami
origami

der Modellbau
model-making

das Kunsthandwerk 2 • arts and crafts 2



die Nähmaschine | sewing machine



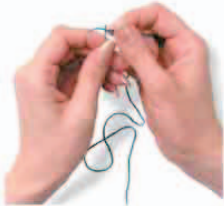

einfädeln
thread (v)



nähen
sew (v)



stopfen
darn (v)



heften
tack (v)



schneiden
cut (v)



die Tapiserie
needlepoint



die Stickerei
embroidery

der Häkelhaken
crochet hook



das Häkeln
crochet



das Makramee
macramé



das Patchwork
patchwork



das Wattieren
quilting

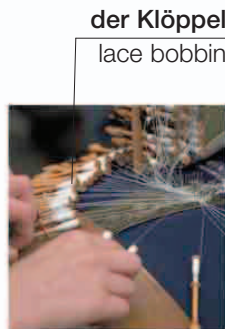

die Spitzenklöppelei
lace-making

der Webstuhl
loom



die Weberei
weaving

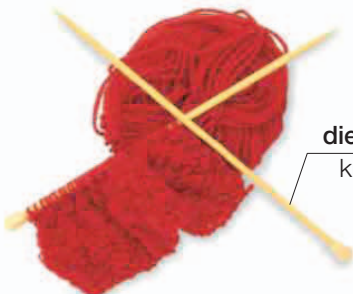

die Stricknadel
knitting needle

das Stricken | knitting



die Wolle
wool

der Strang | skein

Vokabular • vocabulary

auftrennen
unpick (v)

das Nylon
nylon

der Stoff
fabric

die Seide
silk

die Baumwolle
cotton

der Modedesigner
designer

das Leinen
linen

die Mode
fashion

das Polyester
polyester

der Reißverschluss
zipper





die Umwelt
environment



der Weltraum • space

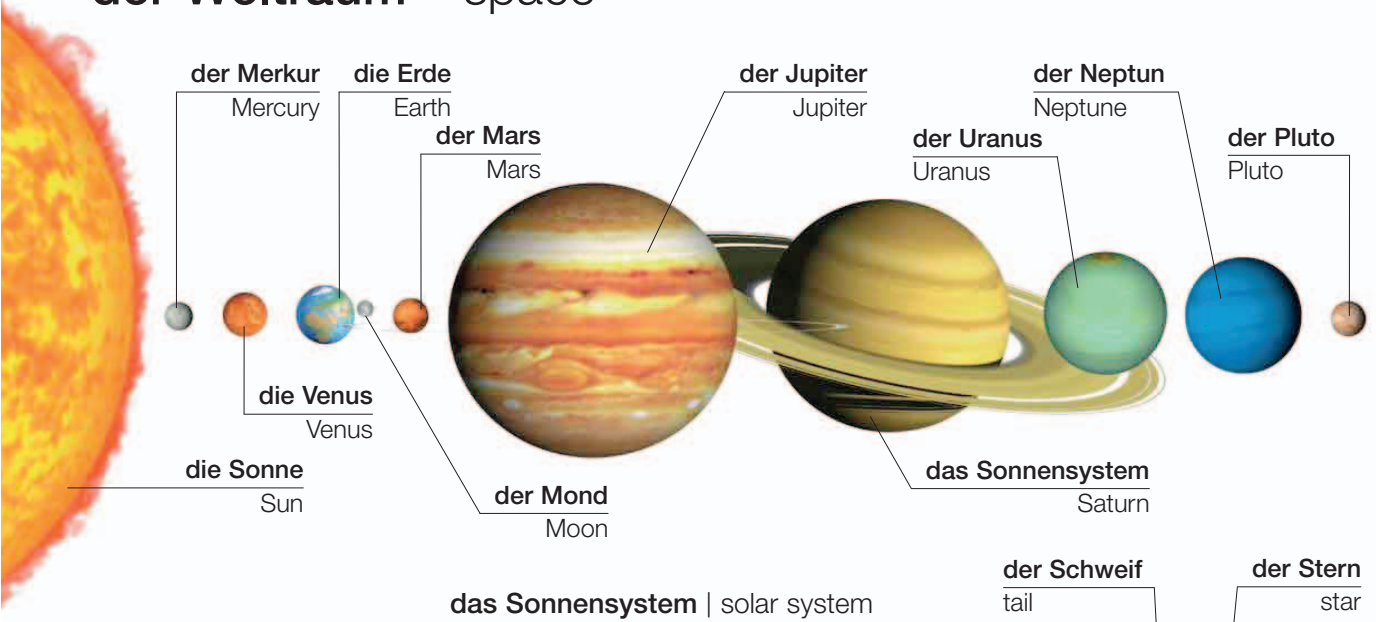

die Galaxie
galaxy



der Nebelfleck
nebula



der Asteroid
asteroid



der Komet
comet

vokabular • vocabulary		
der Planet planet	das Universum universe	der Vollmond full moon
der Meteor meteor	die Umlaufbahn orbit	der Neumond new moon
die Schwerkraft gravity	das schwarze Loch black hole	die Mondsichel crescent moon



die Finsternis | eclipse

die Raumforschung • space exploration

die Raumfähre
space shuttle

der Booster
booster



der Abschuss
launch

der Raumanzug
space suit



der Astronaut | astronaut

die Steuerrakete
thruster

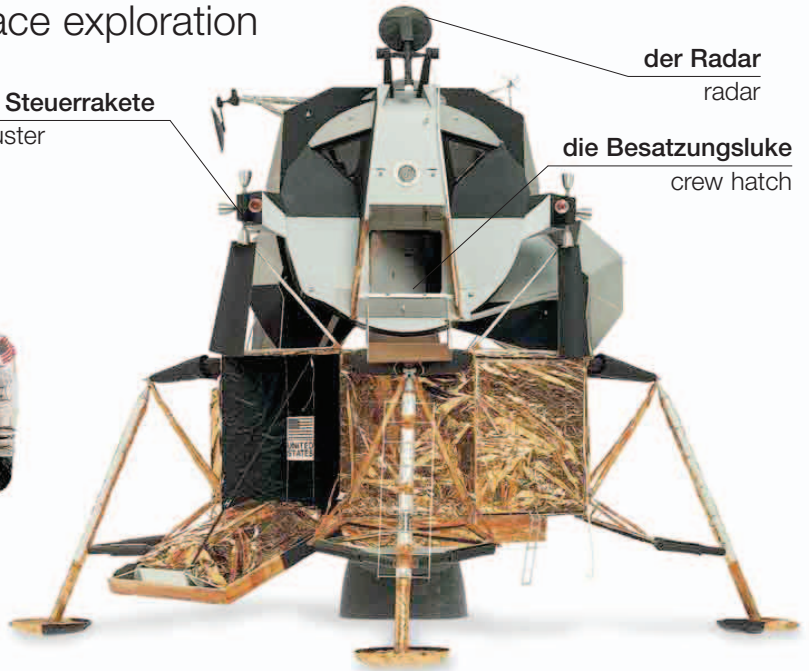

die Mondfähre | lunar module

die Abschussrampe
launch pad

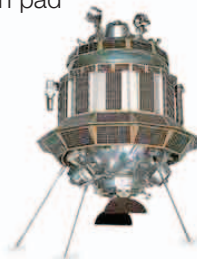

der Satellit
satellite



die Raumstation
space station

die Astronomie • astronomy



das Sternbild
constellation



das Fernglas
binoculars



das Teleskop
telescope

das Stativ
tripod

die Erde • Earth

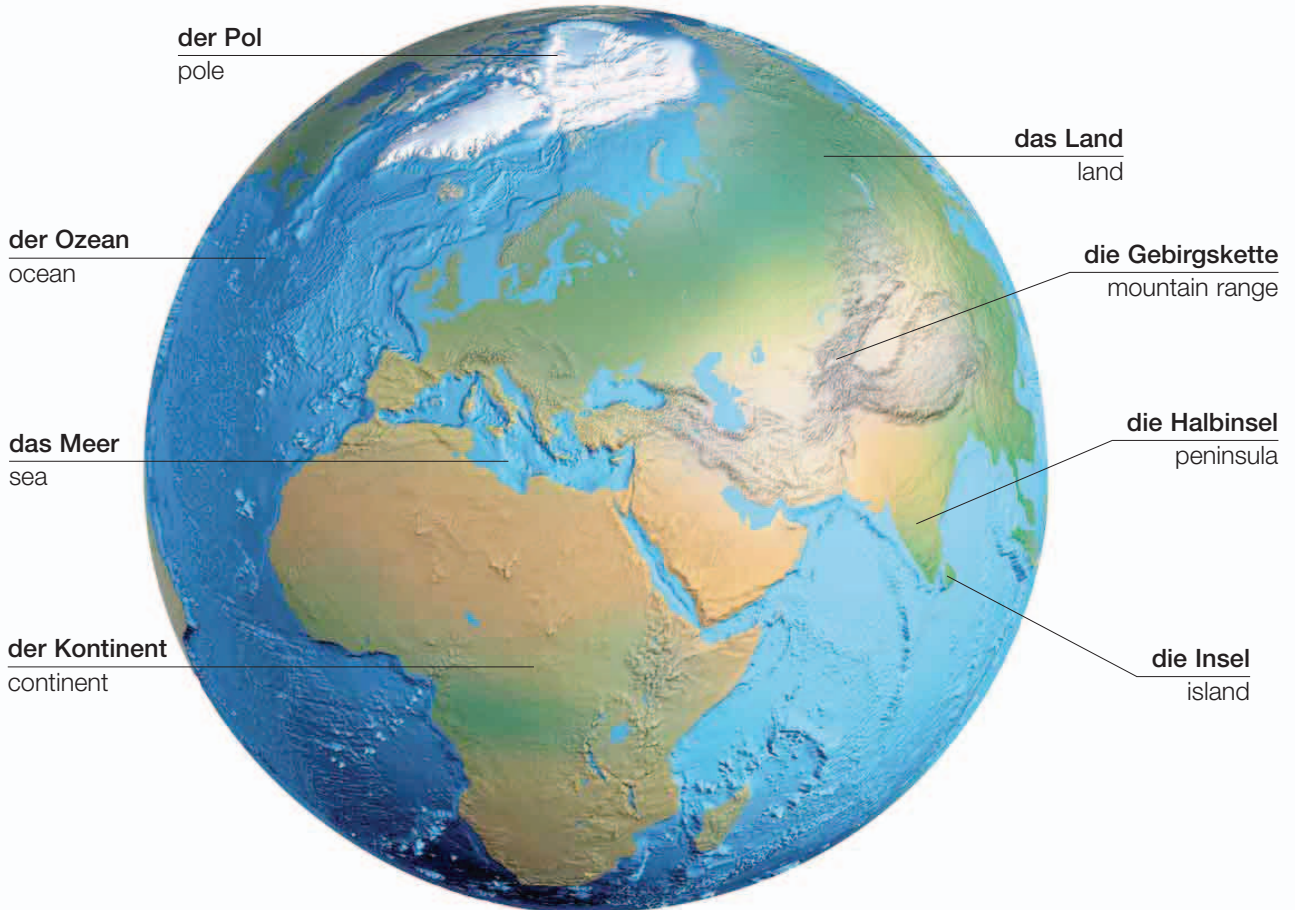

der Planet | planet

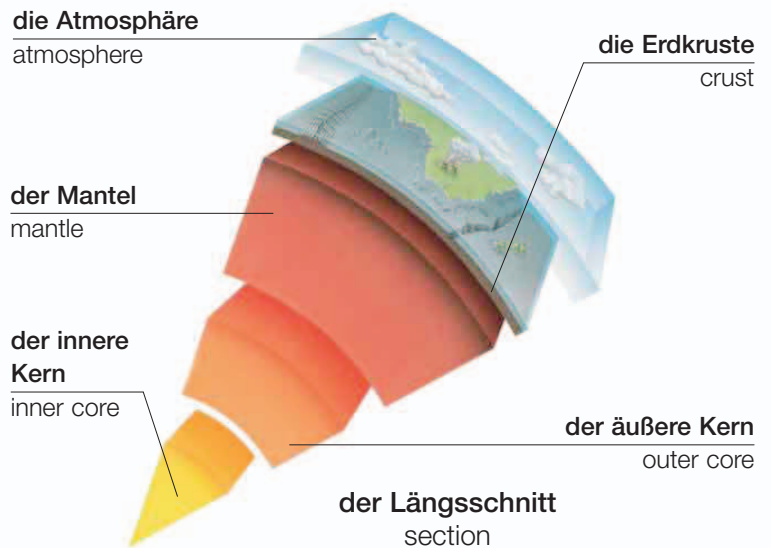

der nördliche Polarkeis

Arctic circle

**der Wendekreis
des Krebses**

tropic of Cancer

**die
Tropen**
tropics

**der Wendekreis des
Steinbocks**

tropic of Capricorn

die Erdzonen | zones

der Nordpol

North Pole

die nördliche Halbkugel

Northern Hemisphere

der Längengrad

longitude

der Breitengrad

latitude

die südliche Halbkugel

Southern Hemisphere

der Äquator

equator

der Vulkan | volcano

die Lava

lava

die Asche

ash

der Schlot

vent

die Kammer

chamber

das Magma

magma



der Krater | crater

Vokabular •

vocabulary

das Erdbeben

earthquake

die Platte

plate

ausbrechen

erupt (v)

das Beben

tremor

die Landschaft • landscape

der Berg
mountain

der Hang
slope

das Ufer
bank

der Fluss
river

die Strom
schnellen
rapids

die Felsen
rocks

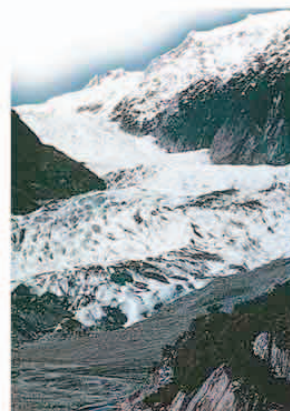
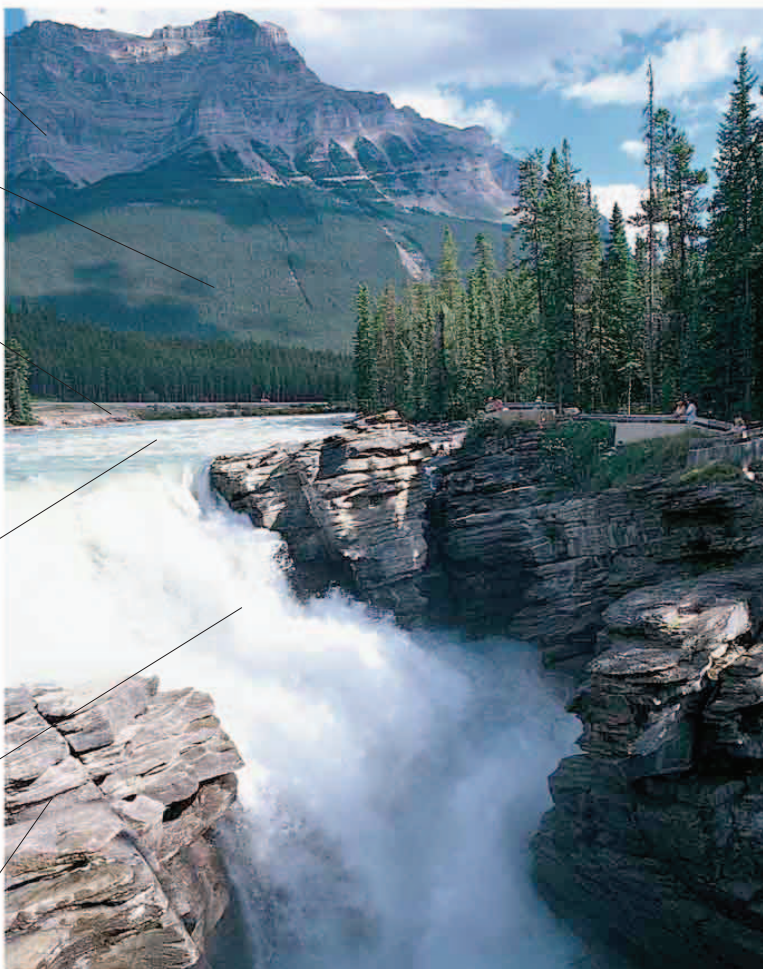

der Gletscher
glacier

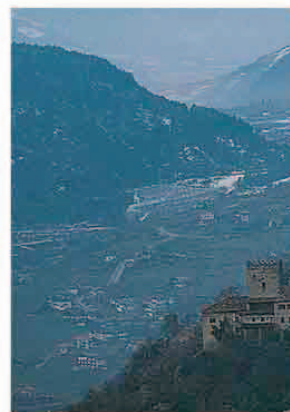

das Tal | valley



der Hügel
hill



das Plateau
plateau



die Schlucht
gorge

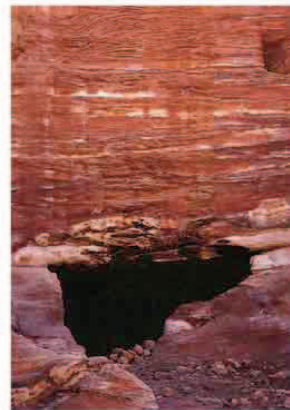

die Höhle
cave



die Ebene | plain



die Wüste | desert



der Wald | forest



der Wald | wood



der Regenwald
rainforest



der Sumpf
swamp



die Wiese label
meadow



das Grasland
grassland



der Wasserfall
waterfall



der Bach
stream



der See
lake



der Geysir
geyser



die Küste
coast

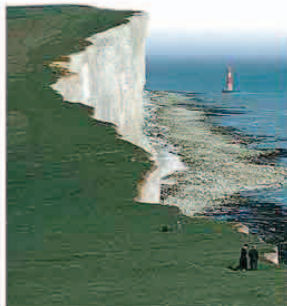

die Klippe
cliff



das Korallenriff
coral reef



die Flussmündung
estuary

das Wetter • weather

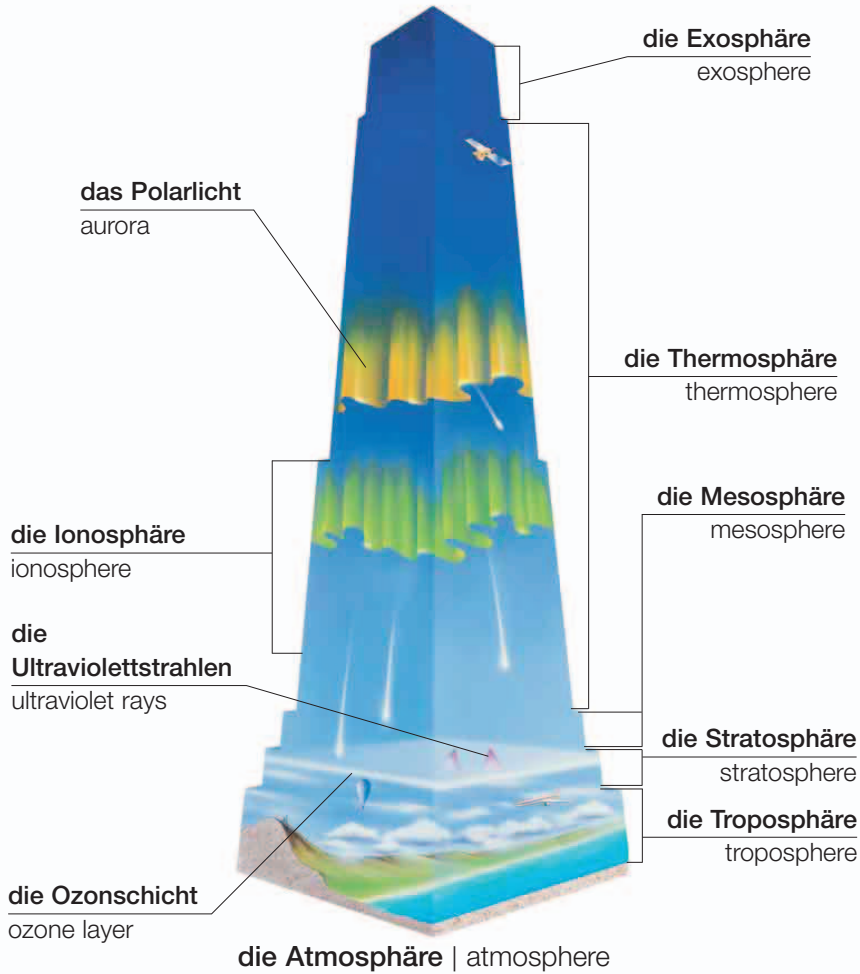

der Sonnenschein
sunshine



der Wind
wind

Vokabular • vocabulary

der Schneeregen
sleet

der Schauer
shower

heiß
hot

trocken
dry

windig
windy

Mir ist heiß/kalt.
I'm hot/cold.

der Hagel
hail

sonnig
sunny

kalt
cold

nass
wet

der Sturm
gale

Es regnet.
It's raining.

der Donner
thunder

bewölkt
cloudy

warm
warm

feucht
humid

die Temperatur
temperature

Es sind ... Grad.
It's ... degrees.

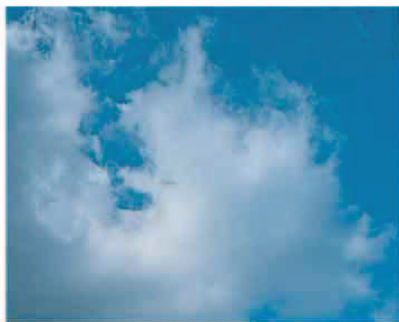

die Wolke
cloud



der Regen
rain



der Blitz
lightning

das Gewitter
storm



der feine Nebel
mist



der dichte Nebel
fog



der Regenbogen
rainbow

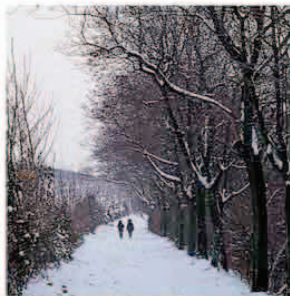

der Schnee
snow



der Raureif
frost



das Eis
ice



der Eiszapfen
icicle

der Frost
freeze



der Hurrikan
hurricane



der Tornado
tornado



der Monsun
monsoon



die Überschwemmung
flood

das Gestein • rocks

eruptiv • igneous



der Granit
granite

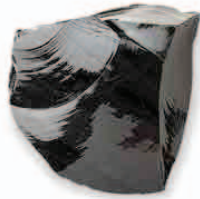

der Obsidian
obsidian



der Basalt
basalt



der Bimsstein
pumice

sedimentär • sedimentary



der Sandstein
sandstone



der Kalkstein
limestone



die Kreide
chalk



der Feuerstein
flint



das
Konglomerat
conglomerate



die Kohle
coal

metamorph • metamorphic



der Schiefer
slate



der Glimmers
schist



der Gneis
gneiss

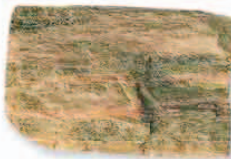

der Marmor
marble

die Schmucksteine • gems

der Rubin
ruby



der Aquamarin
aquamarine



der Amethyst
amethyst



der
Diamant
diamond



der Jade
jade



der Jett
jet



der Smaragd
emerald

der Opal
opal



der Saphir
sapphire

der Mondstein
moonstone



der Granat
garnet



der Topas
topaz



der Turmalin
tourmaline

die Mineralien • minerals



der Quarz
quartz



der Glimmer
mica



der Schwefel
sulfur



der Hämatit
hematite



der Kalzit
calcite



der Malachit
malachite



der Türkis
turquoise



der Onyx
onyx

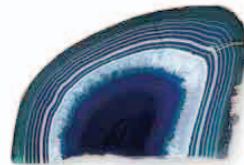

der Achat
agate



der Graphit
graphite

die Metalle • metals



das Gold
gold



das Silber
silver



das Platin
platinum



das Nickel
nickel



das Eisen
iron



das Kupfer
copper



das Zinn
tin



das Aluminium
aluminum



das Quecksilber
mercury

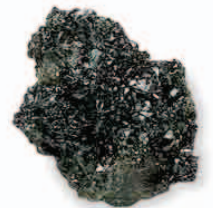

das Zink
zinc

die Tiere 1 • animals 1

die Säugetiere • mammals



das Kaninchen
rabbit



der Hamster
hamster

die Schnurrhaare
whiskers



die Maus
mouse

der Schwanz
tail



die Ratte
rat



der Igel
hedgehog



das
Eichhörnchen
squirrel



die Fledermaus
bat



der Waschbär
raccoon



der Fuchs
fox



der Wolf
wolf

der Welpen
puppy



der Hund
dog

das Kätzchen
kitten



die Katze
cat

das Junge
pup



der Otter
otter



die Robbe
seal



der Seelöwe
sea lion

die Flosse
flipper



das Walross
walrus

das Atemloch
blowhole



der Wal
whale



der Delphin
dolphin



das Geweih
antler

der Hirsch
deer

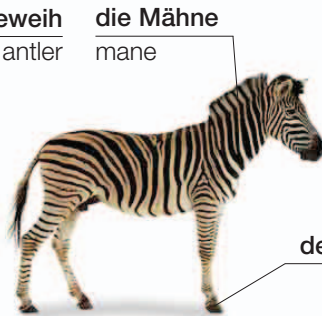

die Mähne
mane

der Huf
hoof

das Zebra
zebra



die Giraffe
giraffe



der Höcker
hump

das Kamel
camel



der Rüssel
trunk

der Stoßzahn
tusk

das Nilferd
hippopotamus

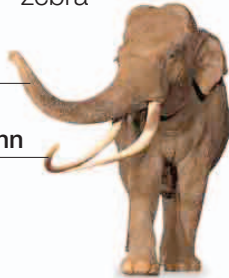

der Elefant
elephant



das Horn
horn

das Nashorn
rhinoceros



der Tiger
tiger

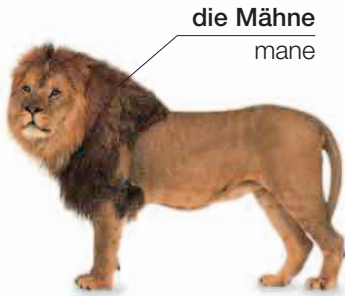

die Mähne
mane

der Löwe
lion



der Affe
monkey



der Gorilla
gorilla



der Koalabär
koala

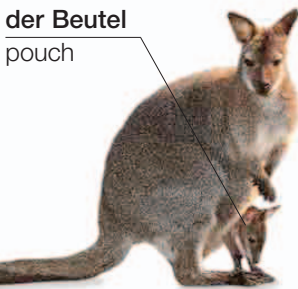

der Beutel
pouch

das Känguru
kangaroo



der Bär
bear

die Klaue
claw



der Eisbär
polar bear

der Pandabär
panda



die Tiere 2 • animals 2

die Vögel • birds



der Kanarienvogel
canary



der Spatz
sparrow



der Kolibri
hummingbird



die Schwalbe
swallow



die Krähe
crow



die Taube
pigeon



der Specht
woodpecker



der Falke
falcon



die Eule
owl



die Möwe
gull



der Adler
eagle



der Pelikan
pelican



der Flamingo
flamingo



der Storch
stork



der Kranich
crane



der Pinguin
penguin



der Strauß
ostrich



die Gans | goose



der Schwan
swan



der Pfau
peacock



der Fasan
pheasant



der Truthahn
turkey



der Kakadu
cockatoo



der Schnabel
bill

die Feder
feather

der Flügel
wing

die Kralle
claw

der Papagei
parrot

die Reptilien • reptiles

die Schuppen
scales



der Alligator
alligator



die Eidechse
lizard

der Leguan
iguana

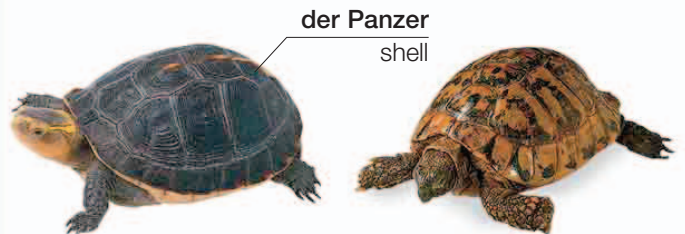

der Panzer
shell

die Wasserschildkröte
turtle

die Schildkröte
tortoise



die Schlange
snake



die Schnauze
snout

das Krokodil
crocodile

die Tiere 3 • animals 3
die Amphibien • amphibians



der Frosch
frog



die Kröte
toad



die Kaulquappe
tadpole



der Salamander
salamander

die Fische • fish



der Aal
eel

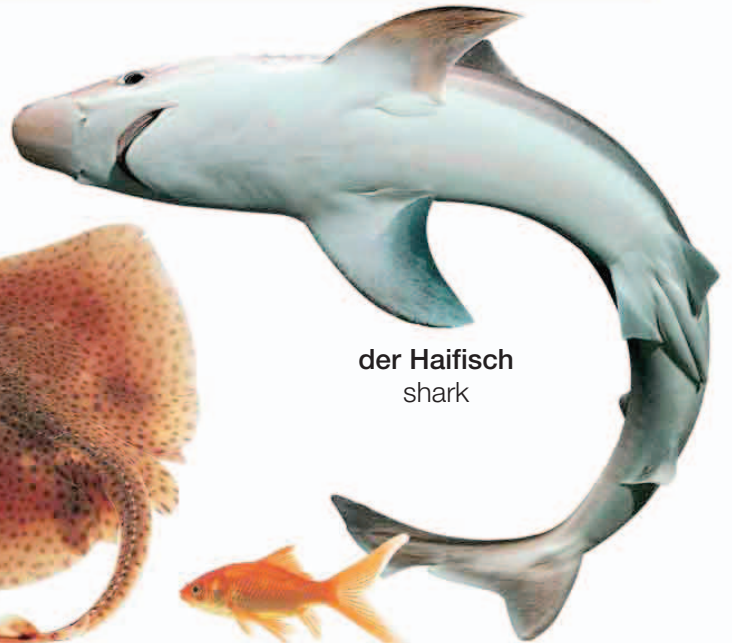

der Haifisch
shark



das Seepferd
sea horse



der Glattrochen
skate



der Rochen
ray



der Goldfisch
goldfish

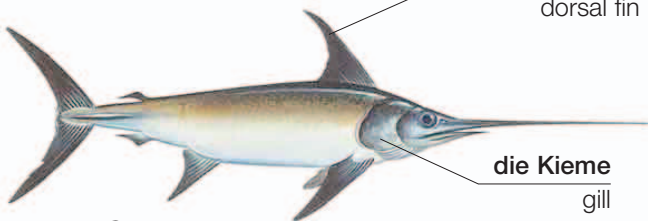

die Rückenflosse
dorsal fin

die Kieme
gill

der Schwertfisch
swordfish

die Brustflosse
pectoral fin

der Schwanz
tail

die Schuppe
scale

der Koikarpfen
koi carp

die Wirbellosen • invertebrates



die Ameise
ant



die Termiten
termites



die Biene
bee



die Wespe
wasp



der Käfer
beetle



der Kakerlak
cockroach



die Motte
moth



der Schmetterling
butterfly

der Fühler
antenna



der Kokon
cocoon



die Raupe
caterpillar



die Grille
cricket



die Heuschrecke
grasshopper



die Gottesanbeterin
praying mantis



der Stachel
sting

der Skorpion
scorpion



der Tausendfüßer
centipede



die Libelle
dragonfly



die Fliege
fly



die Stechmücke
mosquito



der Marienkäfer
ladybug



die Spinne
spider



die Wegschnecke
slug



die Schnecke
snail



der Wurm
worm



der Seestern
starfish



die Muschel
mussel



der Krebs
crab



der Hummer
lobster



der Krake
octopus



der Tintenfisch
squid



die Qualle
jellyfish

die Pflanzen • plants

der Baum • tree

der Ast
branch

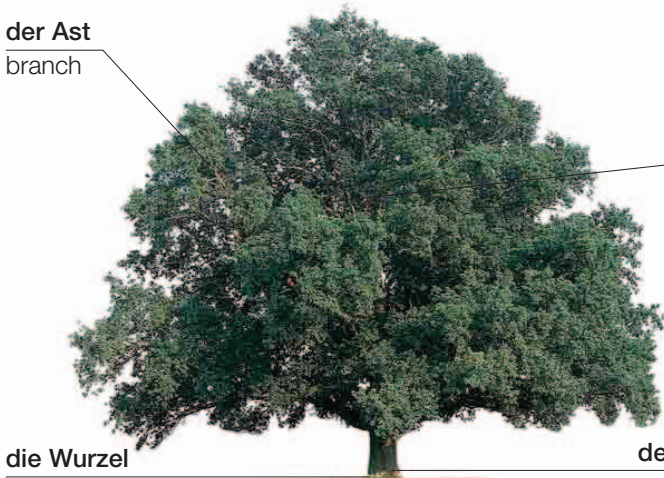

die Wurzel
root



die Eiche
oak



die Lärche
larch



die Buche
beech



die Birke
birch



die Kiefer
pine



die Zeder
cedar



der Ahorn
maple



die Ulme
elm



die Linde
lime



die Stechpalme
holly



die Palme
palm



die Rinde
bark



die Weide
willow



die Pappel
poplar



der Eukalyptus
eucalyptus

die blühende Pflanze • flowering plant

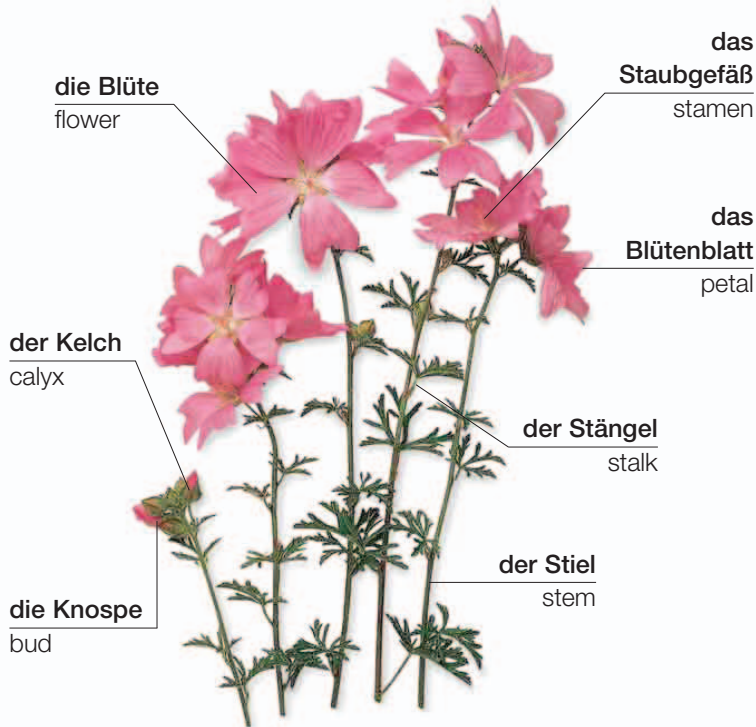

der Hahnenfuß
buttercup



das Gänseblümchen
daisy



die Distel
thistle



der Löwenzahn
dandelion



das Heidekraut
heather



der Klatschmohn
poppy



der Fingerhut
foxglove



das Geißblatt
honeysuckle



die Sonnenblume
sunflower



der Klee
clover



die Sternhyazinthen
bluebells



die Schlüsselblume
primrose



die Lupinen
lupines



die Nessel
nettle

die Stadt • town

die Straße
street

die Bordkante
curb

die Straßenecke
street corner

der Laden
shop



die Kreuzung
intersection

die Einbahn
straße
one-way
system

der
Bürgersteig
sidewalk

das
Bürogebäude
office building

der
Wohnblock
apartment
building

die Gasse
alley

der Parkplatz
parking lot

das Straßenschild
street sign

der Poller
barrier

die Straßenlaterne
street light

die Gebäude • buildings



das Rathaus
town hall



die Bibliothek
library



das Kino
movie theater



das Theater
theater



die Universität
university



der Wolkenkratzer
skyscraper

die Wohngegend • areas



das Industriegebiet
industrial park



die Stadt
city



die Schule
school



der Vorort
suburb



das Dorf
village

Vokabular • vocabulary

die Fußgängerzone
pedestrian zone

die Seitenstraße
side street

der Kanalschacht
utility cover

der Rinnstein
gutter

die Kirche
church

die Allee
avenue

der Platz
square

die Bushaltestelle
bus stop

die Fabrik
factory

der Kanal
drain

die Architektur • architecture

die Gebäude und Strukturen • buildings and structures



der Wolkenkratzer
skyscraper



die Burg
castle



die Kirche
church

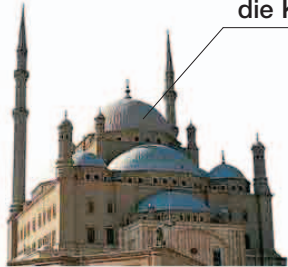

die Moschee
mosque



der Tempel
temple



die Synagoge
synagogue



der Staudamm
dam



die Brücke
bridge

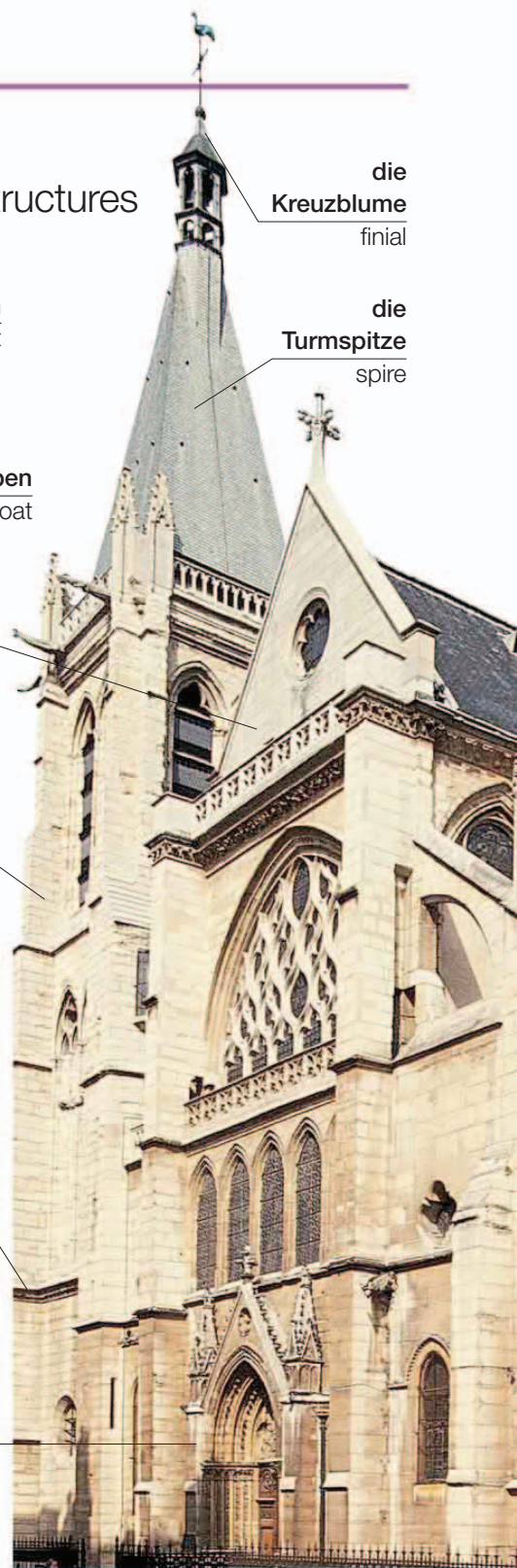

die Kreuzblume
finial

die Turmspitze
spire

der Mauerturm
turret

der Burggraben
moat

der Giebel
gable

die Kuppel
dome

der Turm
tower

das Gewölbe
vault

das Gesims
cornice

die Säule
pillar

die Kathedrale | cathedral

die Baustile • styles



gotisch
gothic

der Architrav
architrave



Renaissance
Renaissance



barock
baroque



der Bogen
arch

der Fries
frieze

der Strebepfeiler
buttress



der Chor
choir

Rokoko
rococo

das Giebeldreieck
pediment



klassizistisch
neoclassical



der Jugendstil
Art Nouveau



Art-déco
Art Deco

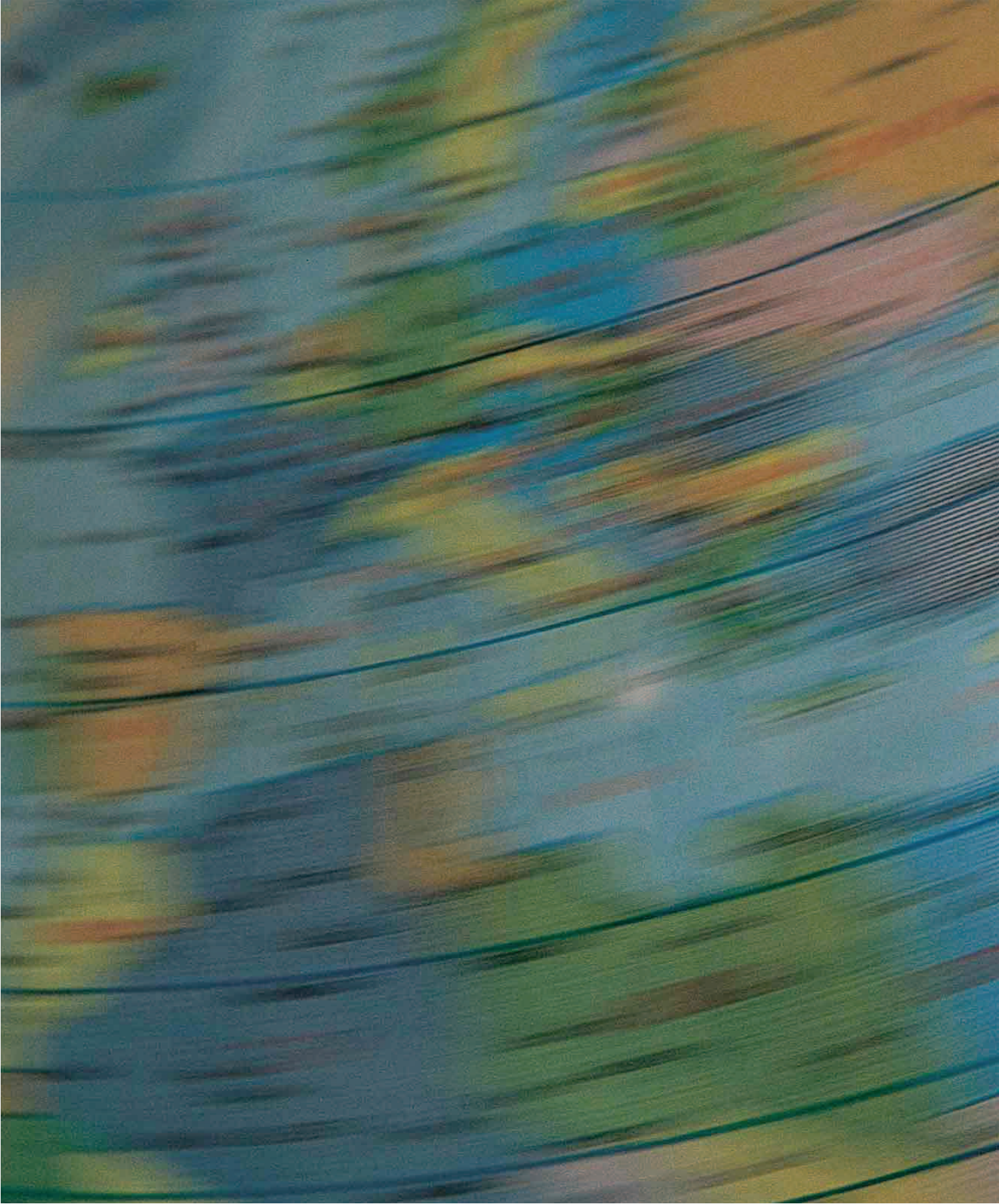



die Information
reference

die Uhrzeit • time



die Uhr
clock

Vokabular • vocabulary

die Stunde hour	jetzt now	zwanzig Minuten twenty minutes
die Minute minute	später later	vierzig Minuten forty minutes
die Sekunde second	eine halbe stunde half an hour	eine Viertelstunde a quarter of an hour

Wie spät ist es?
What time is it? **Es ist drei Uhr.**
It's three o'clock.



fünf nach eins
five after one



zehn nach eins
ten after one



Viertel nach eins
quarter after one



zwanzig nach eins
twenty after one



fünf vor halb zwei
twenty-five after one

der
Sekundenzeiger
second hand



ein Uhr dreißig
one thirty



fünf nach halb zwei
twenty-five to two



zwanzig vor zwei
twenty to two



Viertel vor zwei
quarter to two



zehn vor zwei
ten to two



fünf vor zwei
five to two



zwei Uhr
two o'clock

die Nacht und der Tag • night and day



die Mitternacht
midnight



der Sonnenaufgang
sunrise



die Morgendämmerung
dawn



der Morgen
morning



der Sonnenuntergang
sunset



der Mittag
noon

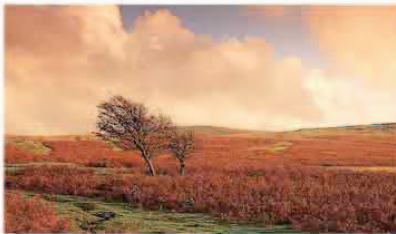

die Abenddämmerung
dusk



der Abend
evening



der Nachmittag
afternoon

Vokabular • vocabulary

früh
early

Du bist früh.
You're early.

Sei bitte pünktlich.
Please be on time.

Wann ist es zu Ende?
What time does it end?

pünktlich
on time

Du hast dich verspätet.
You're late.

Bis später.
I'll see you later.

Wie lange dauert es?
How long will it last?

spät
late

Ich werde bald dort sein.
I'll be there soon.

Wann fängt es an?
What time does it start?

Es ist schon spät.
It's getting late.

der Kalender • calendar

der Monat
month

das Jahr
year

Januar
January

2010



der Tag
day

Montag **Dienstag** **Mittwoch** **Donnerstag** **Freitag** **Samstag** **Sonntag**
Monday Tuesday Wednesday Thursday Friday Saturday Sunday

der Werktag
work day

1	2	3	4	5	6	7
8	9	10	11	12	13	14
15	16	17	18	19	20	21

die Woche
week

das Datum
date

gestern
yesterday

heute
today

morgen
tomorrow

das Wochenende
weekend

Vokabular • vocabulary

Januar
January

März
March

Mai
May

Juli
July

September
September

November
November

Februar
February

April
April

Juni
June

August
August

Oktober
October

Dezember
December

die Jahre • years

1900 neunzehnhundert • nineteen hundred

1901 neunzehnhunderteins • nineteen hundred and one

1910 neunzehnhundertzehn • nineteen ten

2000 zweitausend • two thousand

2001 zweitausendeins • two thousand and one

die Jahreszeiten • seasons



der Frühling
spring



der Sommer
summer



der Herbst
fall



der Winter
winter

Vokabular • vocabulary

das Jahrhundert
century

das Jahrzehnt
decade

das Jahrtausend
millennium

diese Woche
this week

letzte Woche
last week

nächste Woche
next week

vorgestern
the day before yesterday

übermorgen
the day after tomorrow

wöchentlich
weekly

monatlich
monthly

jährlich
annual

Welches Datum haben wir heute?
What's the date today?

Heute ist der siebte Februar zweitausendzwei.
It's February seventh, two thousand and two.

die Zahlen • numbers

0	null • zero	20	zwanzig • twenty
1	eins • one	21	einundzwanzig • twenty-one
2	zwei • two	22	zweiundzwanzig • twenty-two
3	drei • three	30	dreiig • thirty
4	vier • four	40	vierzig • forty
5	fnf • five	50	fnfzig • fifty
6	sechs • six	60	sechzig • sixty
7	sieben • seven	70	siebzig • seventy
8	acht • eight	80	achtzig • eighty
9	neun • nine	90	neunzig • ninety
10	zehn • ten	100	hundert • one hundred
11	elf • eleven	110	hundertzehn • one hundred and ten
12	zwlf • twelve	200	zweihundert • two hundred
13	dreizehn • thirteen	300	dreihundert • three hundred
14	vierzehn • fourteen	400	vierhundert • four hundred
15	fnfzehn • fifteen	500	fnfhundert • five hundred
16	sechzehn • sixteen	600	sechshundert • six hundred
17	siebzehn • seventeen	700	siebenhundert • seven hundred
18	achtzehn • eighteen	800	achthundert • eight hundred
19	neunzehn • nineteen	900	neunhundert • nine hundred

1,000	tausend • one thousand
10,000	zehntausend • ten thousand
20,000	zwanzigtausend • twenty thousand
50,000	fünfzigtausend • fifty thousand
55,500	fünfundfünfzigtausend-fünfhundert • fifty-five thousand five hundred
100,000	hunderttausend • one hundred thousand
1,000,000	eine Million • one million
1,000,000,000	eine Milliarde • one billion

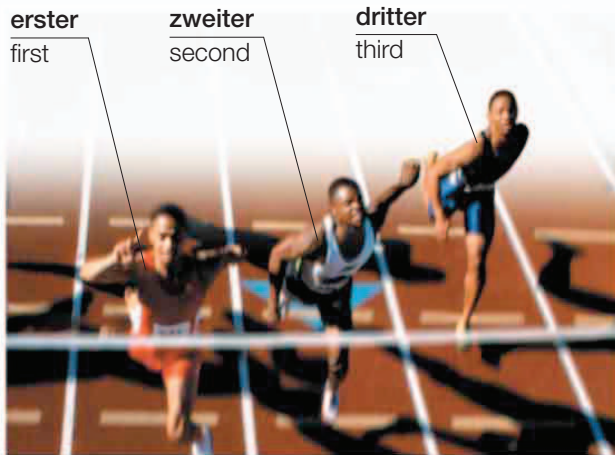

vierter • fourth

fünfter • fifth

sechster • sixth

siebter • seventh

achter • eighth

neunter • ninth

zehnter • tenth

elfter • eleventh

zwölfter • twelfth

dreizehnter • thirteenth

vierzehnter • fourteenth

fünfzehnter • fifteenth

sechzehnter

• sixteenth

siebzehnter

• seventeenth

achtzehnter

• eighteenth

neunzehnter

• nineteenth

zwanzigster

• twentieth

einundzwanzigster

• twenty-first

zweiundzwanzigster

• twenty-second

dreiundzwanzigster

• twenty-third

dreißigster

• thirtieth

vierzigster

• fortieth

fünfzigster

• fiftieth

sechzigster

• sixtieth

siebzigster

• seventieth

achtzigster

• eightieth

neunzigster

• ninetieth

hundertster

• hundredth

die Maße und Gewichte • weights and measures

die Fläche • area

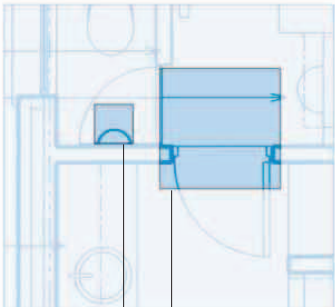

der Quadratfuß
square foot

der Quadratmeter
square meter

die Entfernung • distance

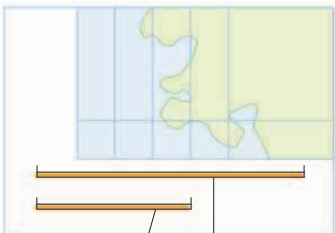

der Kilometer
kilometer

die Meile
mile

die Länge • length

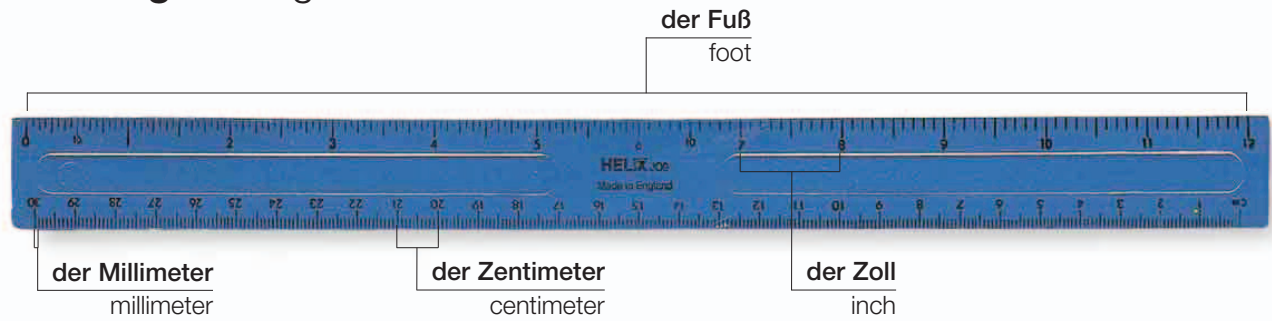

der Millimeter
millimeter

der Zentimeter
centimeter

der Zoll
inch

der Fuß
foot

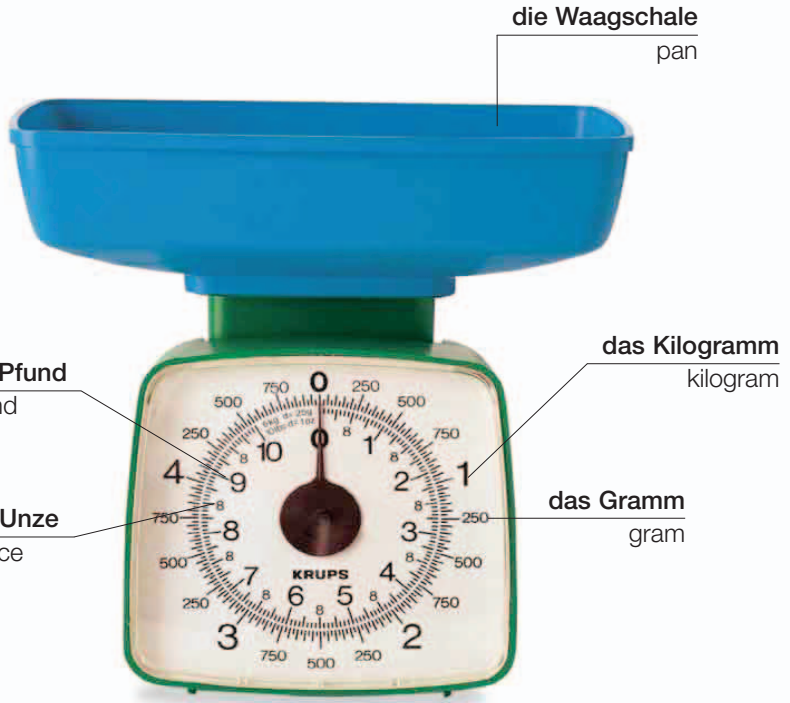

die Waagschale
pan

das Pfund
pound

die Unze
ounce

das Kilogramm
kilogram

das Gramm
gram

die Waage | scale

Vokabular • vocabulary

das Yard
yard

die Tonne
ton

messen
measure (v)

der Meter
meter

das Milligramm
milligram

wiegen
weigh (v)

das Fassungsvermögen • capacity

der halbe Liter
half-liter

das Pint
pint

das Volumen
volume

der Milliliter
milliliter



der Messbecher
measuring cup



das Flüssigkeitsmaß
liquid measure

Vokabular •
vocabulary

die Gallone
gallon

das Quart
quart

der Liter
liter

der Behälter • container



die Tüte
carton



das Päckchen
packet



die Flasche
bottle



der Beutel
bag



die Dose | tub



das Glas | jar

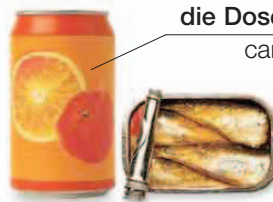

die Dose
can

die Dose | tin



die Spritze
spray bottle



das Stück
bar



die Tube
tube



die Rolle
roll



das Päckchen
pack



die Sprühdose
spray can

die Weltkarte • world map

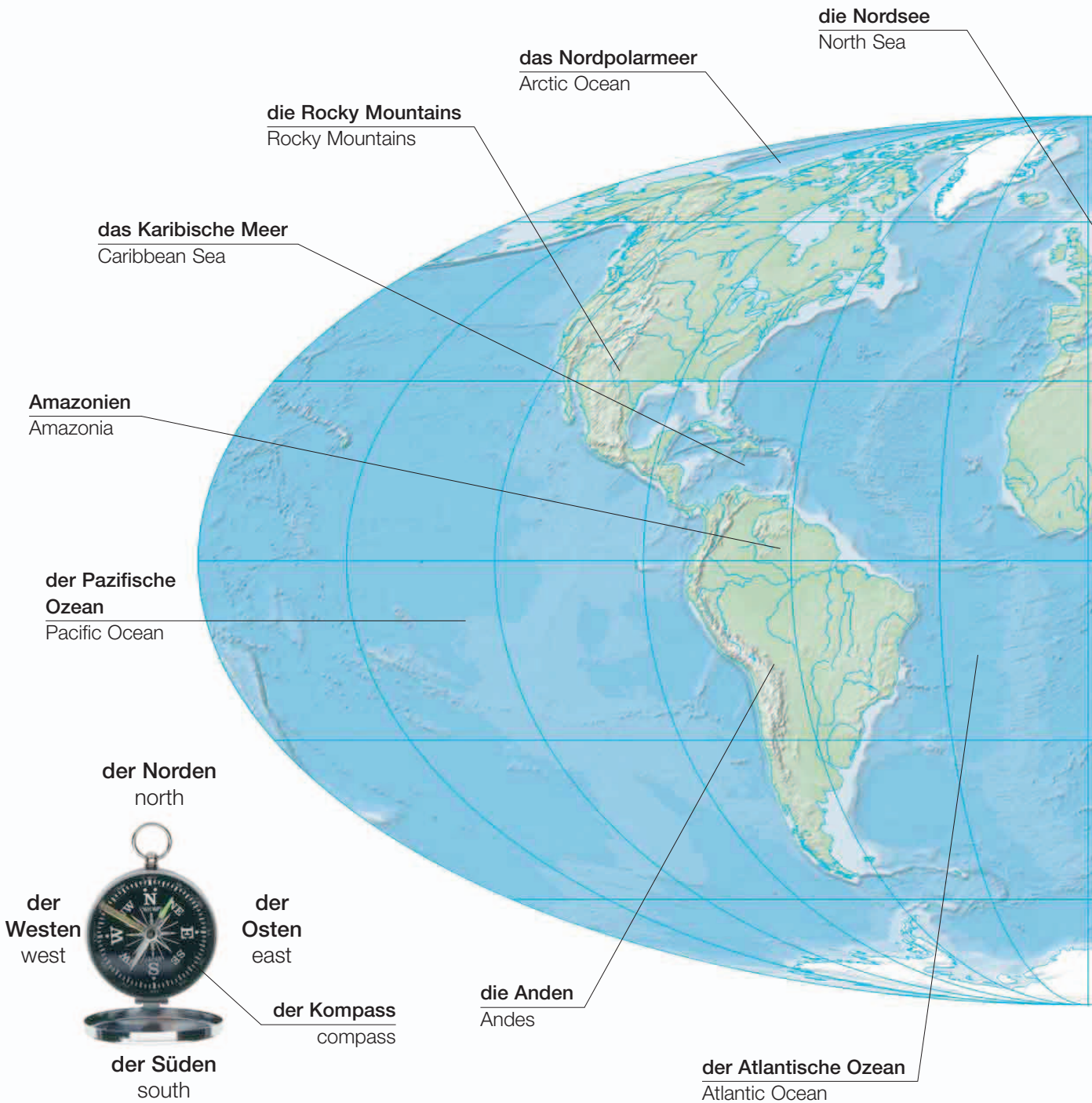

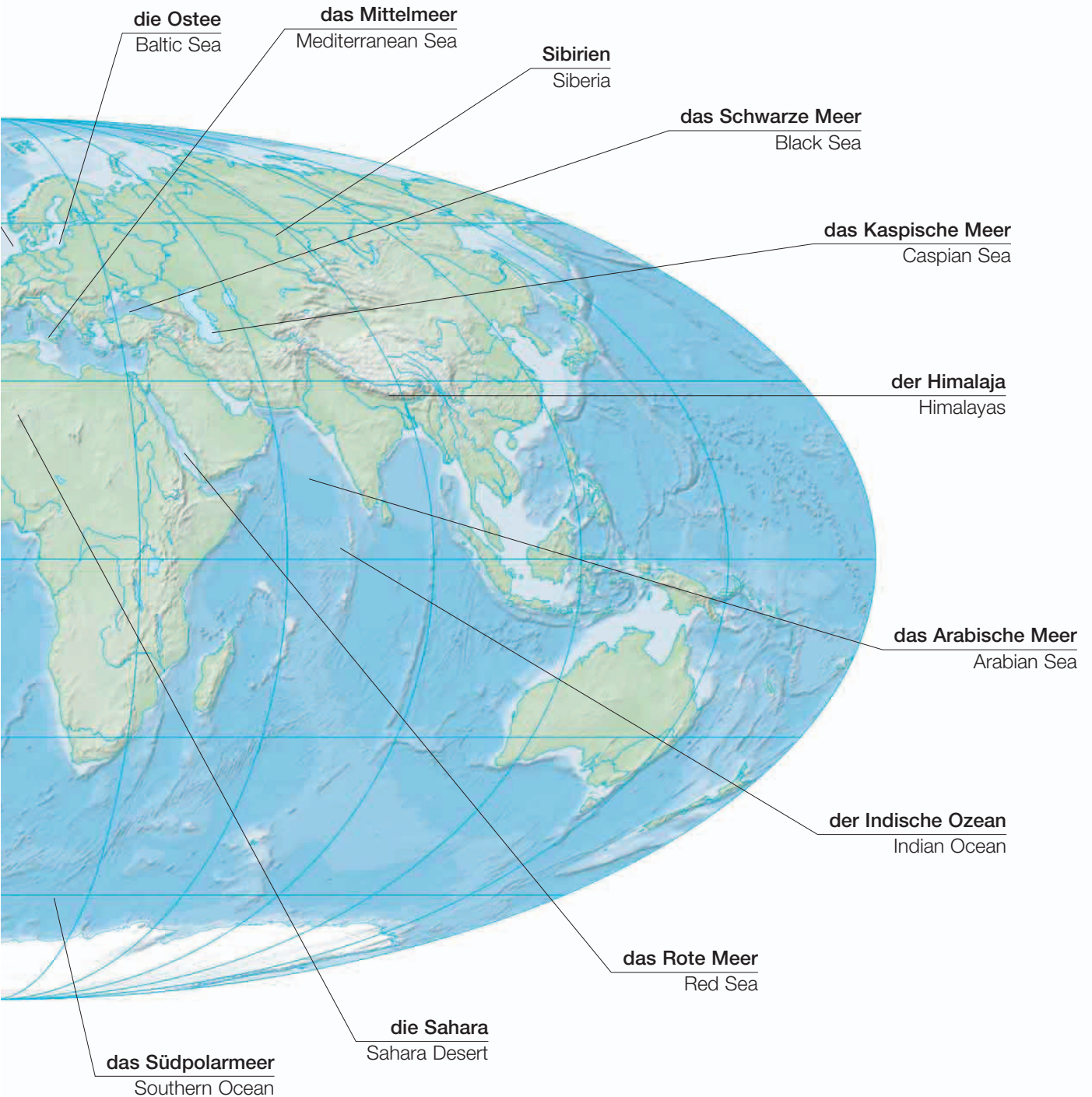

Nord- und Mittelamerika • North and Central America



- 1 **Alaska** • Alaska
- 2 **Kanada** • Canada
- 3 **Grönland** • Greenland
- 4 **die Vereinigten Staaten**
• United States of America
- 5 **Mexiko** • Mexico
- 6 **Guatemala** • Guatemala
- 7 **Belize** • Belize
- 8 **El Salvador** • El Salvador
- 9 **Honduras** • Honduras
- 10 **Nicaragua** • Nicaragua
- 11 **Costa Rica** • Costa Rica
- 12 **Panama** • Panama
- 13 **Kuba** • Cuba
- 14 **die Bahamas** • Bahamas
- 15 **Jamaika** • Jamaica
- 16 **Haiti** • Haiti
- 17 **die Dominikanische Republik**
• Dominican Republic
- 18 **Puerto Rico** • Puerto Rico
- 19 **Barbados** • Barbados
- 20 **Trinidad und Tobago** • Trinidad and Tobago
- 21 **Saint Kitts und Nevis** • St. Kitts and Nevis

- 22 **Antigua und Barbuda** • Antigua and Barbuda
- 23 **Dominica** • Dominica
- 24 **Saint Lucia** • St. Lucia
- 25 **Saint Vinzent und die Grenadinen**
• St. Vincent and The Grenadines
- 26 **Grenada** • Grenada

Südamerika • South America



- 1 **Venezuela** • Venezuela
- 2 **Kolumbien** • Colombia
- 3 **Ecuador** • Ecuador
- 4 **Peru** • Peru
- 5 **die Galapagosinseln**
 - Galapagos Islands
- 6 **Guyana** • Guyana
- 7 **Suriname** • Suriname
- 8 **Französisch-Guayana**
 - French Guiana
- 9 **Brasilien** • Brazil
- 10 **Bolivien** • Bolivia
- 11 **Chile** • Chile
- 12 **Argentinien** • Argentina
- 13 **Paraguay** • Paraguay
- 14 **Uruguay** • Uruguay
- 15 **die Falklandinseln**
 - Falkland Islands

Vokabular • vocabulary

der Staat state	die Kolonie colony	die Zone zone
das Land country	die Provinz province	die Region region
die Nation nation	das Territorium territory	der Bezirk district
der Kontinent continent	das Fürstentum principality	die Hauptstadt capital

Europa • Europe

- 1 **Irland** • Ireland
- 2 **das Vereinigte Königreich**
 - United Kingdom
- 3 **Portugal** • Portugal
- 4 **Spanien** • Spain
- 5 **die Balearen**
 - Balearic Islands
- 6 **Andorra** • Andorra
- 7 **Frankreich** • France
- 8 **Belgien** • Belgium
- 9 **die Niederlande**
 - Netherlands
- 10 **Luxemburg** • Luxembourg
- 11 **Deutschland** • Germany
- 12 **Dänemark** • Denmark
- 13 **Norwegen** • Norway
- 14 **Schweden** • Sweden
- 15 **Finnland** • Finland
- 16 **Estland** • Estonia
- 17 **Lettland** • Latvia
- 18 **Litauen** • Lithuania
- 19 **Kaliningrad** • Kaliningrad
- 20 **Polen** • Poland
- 21 **die Tschechische Republik**
 - Czech Republic
- 22 **Österreich** • Austria
- 23 **Liechtenstein**
 - Liechtenstein
- 24 **die Schweiz**
 - Switzerland
- 25 **Italien** • Italy
- 26 **Monaco**
 - Monaco
- 27 **Korsika** • Corsica
- 28 **Sardinien** • Sardinia
- 29 **San Marino** • San Marino

- 30 **die Vatikanstadt**
 - Vatican City
- 31 **Sizilien** • Sicily
- 32 **Malta** • Malta
- 33 **Slowenien** • Slovenia
- 34 **Kroatien** • Croatia
- 35 **Ungarn** • Hungary
- 36 **die Slowakei** • Slovakia
- 37 **die Ukraine** • Ukraine
- 38 **Weißrussland** • Belarus
- 39 **Moldawien** • Moldova

- 40 **Rumänien** • Romania
- 41 **Jugoslawien** • Yugoslavia
- 42 **Bosnien und Herzegowina**
 - Bosnia and Herzegovina
- 43 **Albanien** • Albania
- 44 **Mazedonien** • Macedonia
- 45 **Bulgarien** • Bulgaria
- 46 **Griechenland** • Greece
- 47 **Kosovo** • Kosovo
- 48 **Montenegro** • Montenegro
- 49 **Island** • Iceland

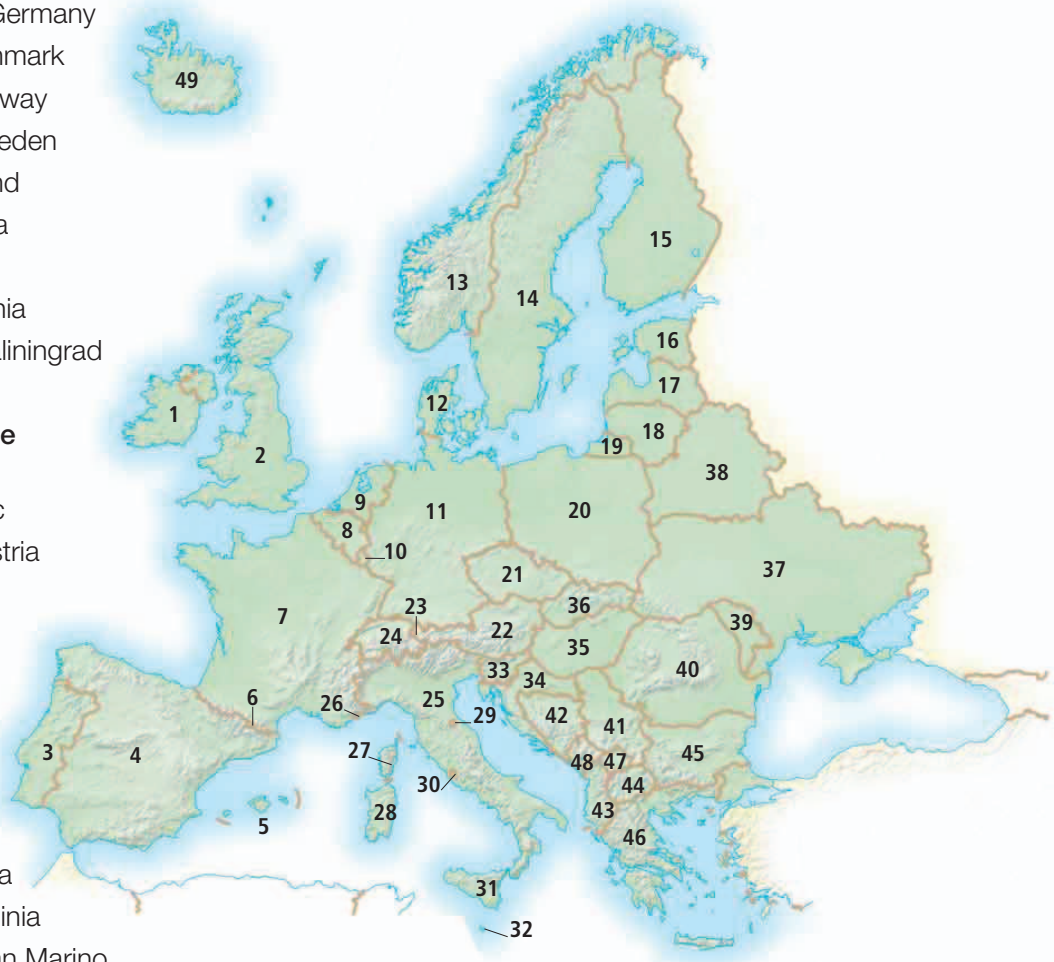

Afrika • Africa

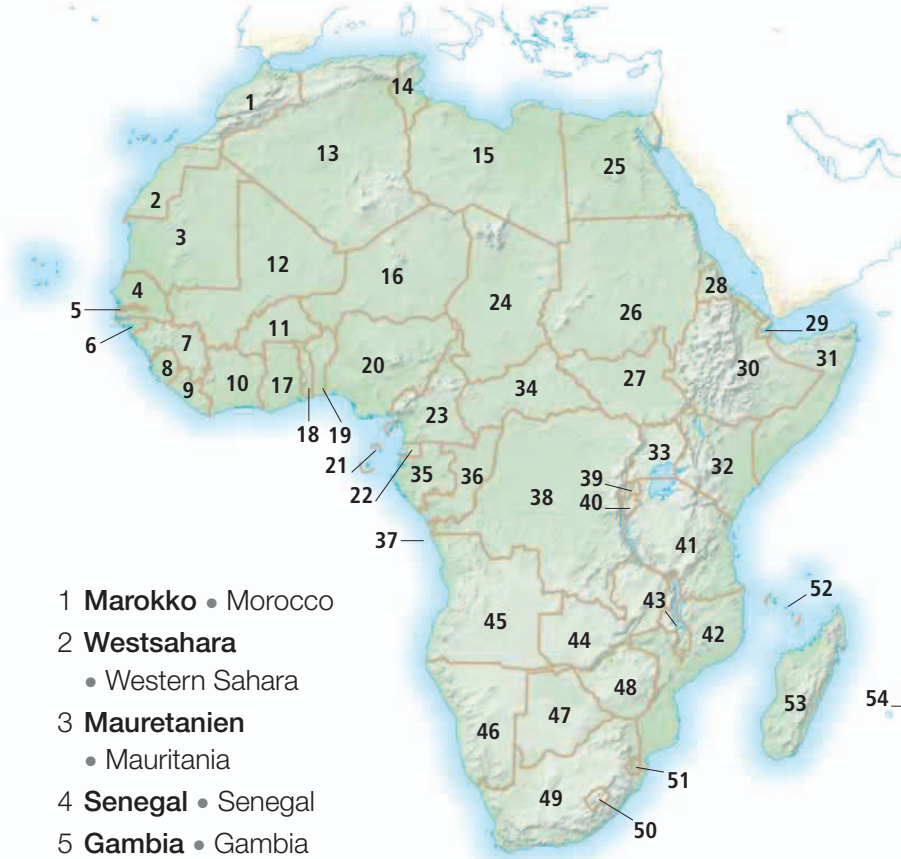

- | | |
|--|---|
| 1 Marokko • Morocco | 33 Uganda • Uganda |
| 2 Westsahara
• Western Sahara | 34 die Zentralafrikanische Republik • Central African Republic |
| 3 Mauretanien
• Mauritania | 35 Gabun • Gabon |
| 4 Senegal • Senegal | 36 Kongo • Congo |
| 5 Gambia • Gambia | 37 Kabinda • Cabinda |
| 6 Guinea-Bissau
• Guinea-Bissau | 38 die Demokratische Republik Kongo • Democratic Republic of the Congo |
| 7 Guinea • Guinea | 39 Ruanda • Rwanda |
| 8 Sierra Leone • Sierra Leone | 40 Burundi • Burundi |
| 9 Liberia • Liberia | 41 Tansania • Tanzania |
| 10 Elfenbeinküste • Ivory Coast | 42 Mosambik • Mozambique |
| 11 Burkina Faso • Burkina Faso | 43 Malawi • Malawi |
| 12 Mali • Mali | 44 Sambia • Zambia |
| 13 Algerien • Algeria | 45 Angola • Angola |
| 14 Tunesien • Tunisia | 46 Namibia • Namibia |
| 15 Libyen • Libya | 47 Botswana • Botswana |
| 16 Niger • Niger | 48 Simbabwe • Zimbabwe |
| 17 Ghana • Ghana | 49 Südafrika • South Africa |
| 18 Togo • Togo | 50 Lesotho • Lesotho |
| 19 Benin • Benin | 51 Swasiland • Swaziland |
| 20 Nigeria • Nigeria | 52 die Komoren • Comoros |
| 21 São Tomé und Príncipe
• São Tomé and Príncipe | 53 Madagaskar • Madagascar |
| 22 Äquatorialguinea
• Equatorial Guinea | 54 Mauritius • Mauritius |
| 23 Kamerun • Cameroon | |
| 24 Tschad • Chad | |
| 25 Ägypten • Egypt | |
| 26 der Sudan • Sudan | |
| 27 Südsudan • South Sudan | |
| 28 Eritrea • Eritrea | |
| 29 Dschibuti • Djibouti | |
| 30 Äthiopien • Ethiopia | |
| 31 Somalia • Somalia | |
| 32 Kenia • Kenya | |

Asien • Asia

- 1 **die Türkei** • Turkey
- 2 **Zypern** • Cyprus
- 3 **die Russische Föderation**
 - Russian Federation
- 4 **Georgien** • Georgia
- 5 **Armenien** • Armenia
- 6 **Aserbaidtschan** • Azerbaijan
- 7 **der Iran** • Iran
- 8 **der Irak** • Iraq
- 9 **Syrien** • Syria
- 10 **der Libanon** • Lebanon
- 11 **Israel** • Israel
- 12 **Jordanien** • Jordan
- 13 **Saudi-Arabien**
 - Saudi Arabia
- 14 **Kuwait** • Kuwait
- 15 **Bahrain** • Bahrain
- 16 **Katar** • Qatar
- 17 **Vereinigte Arabische Emirate**
 - United Arab Emirates
- 18 **Oman** • Oman
- 19 **der Jemen** • Yemen
- 20 **Kasachstan** • Kazakhstan
- 21 **Usbekistan** • Uzbekistan
- 22 **Turkmenistan** • Turkmenistan
- 23 **Afghanistan** • Afghanistan
- 24 **Tadschikistan** • Tajikistan
- 25 **Kirgisistan** • Kyrgyzstan
- 26 **Pakistan** • Pakistan
- 27 **Indien** • India
- 28 **die Malediven** • Maldives
- 29 **Sri Lanka** • Sri Lanka
- 30 **China** • China
- 31 **die Mongolei** • Mongolia
- 32 **Nordkorea** • North Korea
- 33 **Südkorea** • South Korea
- 34 **Japan** • Japan
- 35 **Nepal** • Nepal
- 36 **Bhutan** • Bhutan
- 37 **Bangladesch** • Bangladesh
- 38 **Birmania (Myanmar)**
 - Burma (Myanmar)
- 39 **Thailand** • Thailand
- 40 **Laos** • Laos
- 41 **Vietnam** • Vietnam



Australien und Ozeanien • Australasia



- 1 **Australien** • Australia
- 2 **Tasmanien** • Tasmania
- 3 **Neuseeland** • New Zealand

- 42 **Kambodscha** • Cambodia
- 43 **Malaysia** • Malaysia
- 44 **Singapur** • Singapore
- 45 **Indonesien** • Indonesia
- 46 **Brunei** • Brunei
- 47 **die Philippinen** • Philippines
- 48 **Ost-Timor** • East Timor
- 49 **Papua-Neuguinea** • Papua New Guinea
- 50 **die Salomonen** • Solomon Islands
- 51 **Vanuatu** • Vanuatu
- 52 **Fidji** • Fiji

Partikeln und Antonyme • particles and antonyms

zu, nach
to

von, aus
from

für
for

zu
toward

über
over

unter
under

entlang
along

über
across

vor
in front of

hinter
behind

mit
with

ohne
without

auf
onto

in
into

vor
before

nach
after

in
in

aus
out

bis
by

bis
until

über
above

unter
below

früh
early

spät
late

innerhalb
inside

außerhalb
outside

jetzt
now

später
later

hinauf
up

hinunter
down

immer
always

nie
never

an, bei
at

jenseits
beyond

oft
often

selten
rarely

durch
through

um
around

gestern
yesterday

morgen
tomorrow

auf
on top of

neben
beside

erste
first

letzte
last

zwischen
between

gegenüber
opposite

jede
every

etwas
some

nahe
near

weit
far

gegen
about

genau
exactly

hier
here

dort
there

ein wenig
a little

viel
a lot

groß large	klein small	heiß hot	kalt cold
breit wide	schmal narrow	offen open	geschlossen closed
groß tall	kurz short	voll full	leer empty
hoch high	niedrig low	neu new	alt old
dick thick	dünn thin	hell light	dunkel dark
leicht light	schwer heavy	leicht easy	schwer difficult
hart hard	weich soft	frei free	besetzt occupied
nass wet	trocken dry	stark strong	schwach weak
gut good	schlecht bad	dick fat	dünn thin
schnell fast	langsam slow	jung young	alt old
richtig correct	falsch wrong	besser better	schlechter worse
sauber clean	schmutzig dirty	schwarz black	weiß white
schön beautiful	hässlich ugly	interessant interesting	langweilig boring
teuer expensive	billig cheap	krank sick	wohl well
leise quiet	laut noisy	der Anfang beginning	das Ende end

praktische Redewendungen • useful phrases

wesentliche Redewendungen

- essential phrases

Ja

Yes

Nein

No

Vielleicht

Maybe

Bitte

Please

Danke

Thank you

Bitte sehr

You're welcome

Entschuldigung

Excuse me

Es tut mir Leid

I'm sorry

Nicht

Don't

Okay

OK

In Ordnung

That's fine

Das ist richtig

That's correct

Das ist falsch

That's wrong

Begrüßungen

- greetings

Guten Tag

Hello

Auf Wiedersehen

Goodbye

Guten Morgen

Good morning

Guten Tag

Good afternoon

Guten Abend

Good evening

Gute Nacht

Good night

Wie geht es Ihnen?

How are you?

Ich heiße...

My name is...

Wie heißen Sie?

What is your name?

Wie heißt er/sie?

What is his/her name?

Darf ich... vorstellen

May I introduce...

Das ist...

This is...

Angenehm

Pleased to meet you

Bis später

See you later

Schilder • signs

Touristen-Information

Tourist information

Eingang

Entrance

Ausgang

Exit

Notausgang

Emergency exit

Drücken

Push

Lebensgefahr

Danger

Rauchen verboten

No smoking

Außer Betrieb

Out of order

Öffnungszeiten

Opening times

Eintritt frei

Free admission

Sonderangebot

Special offer

Reduziert

Reduced

Ausverkauf

Sale

Bitte anklopfen

Knock before entering

Betreten des Rasens verboten

Keep off the grass

Hilfe • help

Können Sie mir helfen?

Can you help me?

Ich verstehe nicht

I don't understand

Ich weiß nicht

I don't know

Sprechen Sie

Englisch, Französisch...?

Do you speak English, French...?

Ich spreche Englisch, Spanisch...

I speak English, Spanish...

Sprechen Sie bitte langsamer

Please speak more slowly

Schreiben Sie es bitte für mich auf

Please write it down for me

Ich habe... verloren

I have lost...

Richtungsangaben

- directions

Ich habe mich verlaufen

I am lost

Wo ist der/die/das...?

Where is the...?

Wo ist der/die/das nächste...?

Where is the nearest...?

Wo sind die Toiletten?

Where are the restrooms?

Wie komme ich nach...?

How do I get to...?

Nach rechts

To the right

Nach links

To the left

Geradeaus

Straight ahead

Wie weit ist...?

How far is...?

die Verkehrsschilder

- road signs

Langsam fahren

Slow down

Achtung

Caution

Keine Zufahrt

No entry

Umleitung

Detour

Rechts fahren

Keep right

Autobahn

Freeway

Parkverbot

No parking

Sackgasse

No through road

Einbahnstraße

One-way street

Vorfahrt gewähren

Yield

Anlieger frei

Residents only

Baustelle

Road construction

gefährliche Kurve

Dangerous bend

Unterkunft

- accommodation

Haben Sie Zimmer frei?

Do you have any vacancies?

Ich habe ein Zimmer reserviert

I have a reservation

Wo ist der Speisesaal?

Where's the dining room?

Wann gibt es Frühstück?

What time is breakfast?

Ich bin um ... Uhr wieder da

I'll be back at ... o'clock

Ich reise morgen ab

I'm leaving tomorrow

Essen und Trinken

- eating and drinking

Zum Wohl!

Cheers!

Es ist köstlich/scheußlich

It's delicious/awful

Ich trinke/rauche nicht

I don't drink/smoke

Ich esse kein Fleisch

I don't eat meat

Nichts mehr, danke

No more for me, thank you

Könnte ich noch etwas mehr haben?

May I have some more?

Wir möchten bitte zahlen

Bill/check, please

Ich hätte gerne eine Quittung

Can I have a receipt?

Nichtraucherbereich

No-smoking area

die Gesundheit

- health

Ich fühle mich nicht wohl

I don't feel well

Mir ist schlecht

I feel sick

Können Sie einen Arzt holen?

Can you get me a doctor?

Wird er/sie sich wieder erholen?

Will he/she be all right?

Es tut hier weh

It hurts here

Ich habe Fieber

I have a fever

Ich bin im ... Monat schwanger

I'm ... months pregnant

Ich brauche ein Rezept für ...

I need a prescription for ...

Ich nehme normalerweise ...

I normally take ...

Ich bin allergisch gegen ...

I'm allergic to ...

deutsches register • German index

- A**
à la carte 152
Aal *m* 294
Abdeckband *n* 83
Abdecktuch *n* 83
Abend *m* 305
Abenddämmerung *f* 305
Abendessen *n* 64
Abendkleid *n* 34
Abendmenü *n* 152
Abenteuerfilm *m* 255
Abfahrtslauf *m* 247
Abfalleimer *m* 61
Abfallentsorgung *f* 61
Abfallsortiereinheit *f* 61
Abfertigungsschalter *m* 213
Abflug *m* 213
Abflughalle *f* 213
Abfluss *m* 61, 72
Abflussrohr *n* 61
Abführmittel *n* 109
abheben 99
Abhebungsformular *m* 96
Abkühlgitter *n* 69
Ablage für Ausgänge *f* 172
Ablage für Eingänge *f* 172
Ablasshahn *m* 61
Ableger *m* 91
Abmessungen *f* 165
Absatz *m* 37
Abschlag *m* 232
abschleppen 195
Abschleppwagen *m* 203
Abschnitt *m* 96
Abschürfung *f* 46
Abschuss *m* 281
Abschussrampe *f* 281
Abseilen *n* 248
Abseits *n* 223
abseits der Piste 247
Absender *m* 98
Absperrhahn *m* 61
Abspielen *n* 269
Abteil *n* 209
Abteilungen *f* 49
Abtropfbrett *n* 67
Abzeichen *n* 189
abziehen 82
Abzug *m* 271
Accessoires *n* 36
Achat *m* 289
Achillessehne *f* 16
Achse *f* 205
Achselhöhle *f* 13
acht 308
Achteck *n* 164
achter 309
Achterdeck *n* 214
achthundert 308
achtzehn 308
achtzehnter 309
achtzig 308
achtzigster 309
Ackerbaubetrieb *m* 183
Ackerland *n* 182
Acrylfarbe *f* 274
Adamsapfel *m* 19
addieren 165
Adler *m* 292
Adresse *f* 98
Adzukibohnen *f* 131
Affe *m* 291
Afghanistan 318
Afrika 317
After-Sun-Lotion *f* 108
Ägypten 317
Ahorn *m* 296
Ahornsirup *m* 134
Aikido *n* 236
Airbag *m* 201
akademische Grad *m* 169
Akazie *f* 110
Aktenordner *m* 173
Aktenschrank *m* 172
Aktentasche *f* 37
Aktien *f* 97
Aktienpreis *m* 97
Aktionen *f* 227, 229, 233
Aktivitäten *f* 162, 245, 263
Aktivitäten im Freien *f* 262
Akupressur *f* 55
Akupunktur *f* 55
Alarmanlage *f* 58
Alaska 314
Albanien 316
Algerien 317
alkoholfreie Getränk *n* 154
alkoholfreien Getränke *n* 144
alkoholischen Getränke *n* 145
Allee *f* 299
Allergie *f* 44
Alligator *m* 293
Allzweckraum *m* 76
Alpenpflanze *f* 87
alpine Kombination *f* 247
als Fänger spielen 229
alt 321
Alternativtherapien *f* 54
Aluminium *n* 289
Amazonien 312
ambulante Patient *m* 48
Ameise *f* 295
Amethyst *m* 288
Amniozentese *f* 52
Ampère *n* 60
Amphibien *f* 294
an Bord gehen 217
an, bei 320
analog 179
Ananas *f* 128
Ananassaft *m* 149
Anästhesist *m* 48
Anbau *m* 58
anbeißen 245
anbraten 67
anbringen 82
Anden 312
Andenken *n* 260
andere Geschäfte *n* 114
andere Kunstfertigkeiten *f* 275
andere Schiffe *n* 215
andere Sportarten *f* 248
Andorra 316
Anfang *m* 321
Angebot *n* 174
Angebote *n* 106
Angeklagte *m* 180, 181
Angelgeräte *n* 245
Angelhaken *m* 244
Angelrute *f* 244
Angelschein *m* 245
Angelsport *m* 244
angemacht 159
angereicherte Mehl *n* 139
Angler *m* 244
Angola 317
angreifen 220, 223
Angriff *m* 220, 237
Angriffszone *f* 224
Anhang *m* 177
Anhänger *m* 36, 266
Anker *m* 214, 240
Ankerwinde *f* 214
Anklage *f* 94, 180
Ankunft *f* 213
anlegen 217
Anorak *m* 31, 33
Anprobe *f* 104
Anreden *f* 23
Anrufbeantworter *m* 99
Anspielkreis *m* 224
anstreichen 83
Antifalten- 41
Antigua und Barbuda 314
Antiquitätenladen *m* 114
Antiseptikum *n* 47
Antwort *f* 163
antworten 163
Anwaltsbüro *n* 180
Anwendung *f* 176
Anzeigetafel *f* 104, 225
Aperitif *m* 153
Apfel *m* 126
Apfelsaft *m* 149
Apfelstecher *m* 68
Apfelwein *m* 145
Apfelweinessig *m* 135
Apotheke *f* 108
Apotheker *m* 108
Apothekerin *f* 189
App *f* 99
Apparat *m* 99
applaudieren 255
Aprikose *f* 126
April *m* 306
Aquamarin *m* 288
Aquarellfarbe *f* 274
Äquator *m* 283
Äquatorialguinea 317
Arabische Meer *n* 313
Arbeit *f* 172
Arbeitgeberin *f* 24
Arbeitnehmer *m* 24
Arbeitsessen *n* 175
Arbeitsfläche *f* 66
Arbeitszimmer *n* 63
Architekt *m* 190
architektonische Garten *m* 84
Architektur *f* 300
Architrav *m* 301
Argentinien 315
Arithmetik *f* 165
Arm *m* 13
Armaturen *f* 201
Armaturenbrett *n* 201
Armband *n* 36
Ärmel *m* 34
ärmellos 34
Armenien 318
Arملهne *f* 210
Armstütze *f* 200
Aromatherapie *f* 55
aromatisch 130
aromatische Öl *n* 134
Art-déco- 301
Arterie *f* 19
Artischocke *f* 124
Arzt *m* 45, 189
Aschbecher *m* 150
Asche *f* 283
Aserbaidschan 318
Asien 318
Asphalt *m* 187
Ass *n* 230, 273
Assistentin *f* 24
assistierte Entbindung *f* 53
Ast *m* 296
Asteroid *m* 280
Asthma *n* 44
Astigmatismus *m* 51
Astronaut *m* 281
Astronomie *f* 281
Atemloch *n* 290
ätherischen Öle *n* 55
Äthiopien 317
Atlantische Ozean *m* 312
Atmosphäre *f* 282, 286
Atmung *f* 47
Atmungssystem *n* 19
Atrium *n* 104
Aubergine *f* 125
auf 320
auf der Stelle joggen 251
aufgehen 139
aufgenommen 48
aufgeregt 25
Aufhängung *f* 203, 205
aufkreuzen 241
Auflaufform *f* 69
Auflaufförmchen *n* 69
auflockern 91
Auflösungszeichen *n* 256
Aufnahme *f* 269
Aufsatz *m* 163, 233
Aufschlag *m* 231
aufschlagen 231
Aufschlaglinie *f* 230
aufstehen 71
auftauen 67
auftrennen 277
aufwachen 71
aufwärmen 154
Auge *n* 14, 51
Augenbraue *f* 14, 51
Augenbrauenstift *m* 40
Augenoptiker *m* 51
August *m* 306
aus 225, 226, 228, 320
aus Freilandhaltung 118
ausblasen 141
ausbrechen 283
Ausfahrt *f* 194
Ausfall *m* 251
Ausgang *m* 210
Ausgehen *n* 75
Auskunft *f* 99, 168
Auskunft *f* 99
ausländische Währung *f* 97
Auslandsflug *m* 212
Auslass *m* 61
auslaufen 217
Ausleger *m* 95
Auslegerkorb *m* 95
Ausleihe *f* 168
Ausleihe *m* 168
ausleihen 168
Auslöser *m* 270
Auspuff *m* 203
Auspuffrohr *n* 204
Auspufftopf *m* 203
ausrollen 67
Ausrüstung *f* 165, 233, 238
Aussage *f* 180
Außenbordmotor *m* 215
Außenfeld *n* 229
Außenür *f* 59

- Äussere *n* 198
 äussere Erscheinung *f*
 30
 äussere Kern *m* 282
 außerhalb 320
 ausspülen 38
 Ausstellung *f* 261
 Ausstellungsstück *n*
 261
 ausstrecken 251
 Auster *f* 121
 Australien 319
 Auswechslung *f* 223
 auswerfen 245
 Auszeit *f* 220
 Auto *n* 198, 200
 Autobahn *f* 194
 Automatiktür *f* 196
 Autostereoanlage *f* 201
 Autotür *f* 198
 Autounfall *m* 203
 Autoverleih *m* 213
 Autowaschanlage *f* 198
 Avocado *f* 128
 Ayurveda *n* 55
- B**
 Baby *n* 23, 30
 Babybecher *m* 75
 Babyflasche *f* 75
 Babyhandschuhe *m* 30
 Babyprodukte *n* 107
 Babyschuhe *m* 30
 Babysprechanlage *f* 75
 Babytasche *f* 75
 Babytrageschlinge *f* 75
 Babywanne *f* 74
 Bach *m* 285
 Backe *f* 14
 backen 67, 138
 Backenzahn *m* 50
 Bäcker *m* 139
 Bäckerei *f* 114, 138
 Backgammon *n* 272
 Backofen *m* 66
 Backpflaume *f* 129
 Backpinsel *m* 69
 Backwaren *f* 107
 Badeanzug *m* 238, 265
 Badehose *f* 238
 Badekappe *f* 238
 Bademantel *m* 32, 73
 Badematte *f* 72
 Bademeister *m* 239
 baden 72
 Badetuch *n* 73
 Badewanne *f* 72
 Badezimmer *n* 72
 Badminton *n* 231
 Bagger *m* 187
 baggern 227
 Baguette *n* 138
 Bahamas 314
 Bahn *f* 234, 238
 Bahnhof *m* 208
 Bahnhofshalle *f* 209
 Bahnnetz *m* 209
 Bahnsteig *m* 208
- Bahrain 218
 Baiser *n* 140
 Balearen 316
 Balken *m* 186
 Balkon *m* 59, 254
 Ball *m* 75
 Ballen *m* 15, 184
 Ballett *n* 255
 Ballettröckchen *n* 191
 Balljunge *m* 231
 Ballwechsel *m* 230
 Bambus *m* 86, 122
 Banane *f* 128
 Band *n* 27, 39, 47, 141
 Bandage *f* 47
 Bangladesch 318
 Bank *f* 96, 250, 262
 Bankgebühr *f* 96
 Banküberweisung *f* 96
 Bar *f* 150, 152
 Bär *m* 291
 Bar Mizwa *f* 26
 Barbados 314
 Barhocker *m* 150
 Barkeeper *m* 150, 191
 barock 301
 Barren *m* 235
 Basalt *m* 288
 Baseball *m* 228
 Basilikum *n* 133
 Basketball *m* 226
 Basketballspieler *m* 226
 Bassgitarre 258
 Bassklarinetten *f* 257
 Bassschlüssel *m* 256
 Batterie *f* 78, 167, 202,
 Batterien *f* 260
 Bau *m* 186
 Bauarbeiter *m* 186
 Bauch *m* 12
 Bauchmuskeln *m* 16
 Bauchspeicheldrüse *f*
 18
 bauen 186
 Bauer *m* 182, 189, 272
 Bauerngarten *m* 84
 Bauernhaus *n* 182
 Bauernhof *m* 182, 184
 Bauhandwerker *m* 188
 Bauholz *n* 187
 Baum *m* 86, 240, 296
 Baumwolle *f* 184, 277
 Baustelle *f* 186
 Baustile *m* 301
 Beat *m* 259
 Beben *n* 283
 Becher *m* 65
 Becherglas *n* 167
 Becken *n* 17, 61, 257
 Bedienung 152
 Beere *f* 296
 Befestigungen *f* 89
 Befruchtung *f* 20
 Begräbnis *n* 26
 Behälter *m* 311
 Behandlungslampe *f* 50
 Behandlungsschürze
 f 50
- Behindertenparkplatz *m*
 195
 Beil *n* 95
 Beilage *f* 153
 Beilagenteller *m* 65
 Bein *n* 12, 64
 Beinstütz *m* 251
 Beize *f* 79
 Bekannte *m* 24
 belegt 321
 belegte Brot *n* 155
 Beleuchtung *f* 178
 Belgien 316
 Belichtung *f* 271
 Belichtungsmesser *m*
 270
 Belize 314
 Benin 317
 Benzin *n* 199
 Benzinpreis *m* 199
 Benzintank *m* 203
 Beraterin *f* 55
 Berg *m* 284
 Berg-und-Talbahn *f* 262
 Bericht *m* 174
 Berufe *m* 188, 190
 Berufung *f* 181
 Beruhigungsmittel *n* 109
 berühmte Ruine *f* 261
 Besatzungsluke *f* 281
 beschneiden 91
 Beschwerde *f* 94
 Besen *m* 77
 besetzt 99, 321
 Besetzung *f* 254
 Besichtigungstour *f* 260
 besorgt 25
 Besteck *n* 64
 bestellen 153
 Bestuhlung *f* 254
 bestürzt 25
 Besuchszeiten *f* 48
 Betonblock *m* 187
 Betonmischmaschine *f*
 186
 Betrug *m* 96
 Betrieb für
 Milchproduktion *m*
 183
 Bett *n* 70
 Bettcouch *f* 63
 Bettdecke *f* 71
 Bettlaken *n* 71
 Bettwäsche *f* 71
 Bettzeug *n* 74
 beugen 251
 Beutel *m* 291, 311
 bewässern 183
 Beweismittel *n* 181
 bewölkt 286
 bewusstlos 47
 bezahlen 153
 Beziehungen *f* 24
 Bezirk *m* 315
 Bhutan 318
 Biathlon *n* 247
 Bibliothek *f* 168, 299
 Bibliothekar *m* 190
- Bibliothekarin *f* 168
 Bidet *n* 72
 Biene *f* 295
 Bier *n* 145, 151
 Bifokal- 51
 Bikini *m* 264
 Bilderrahmen *m* 62
 Bildhauer *m* 191
 Bildhauerei *f* 275
 Bildschirm *m* 97, 172,
 176, 269
 Bildsucher *m* 271
 Birnsstein *m* 73, 288
 Binse *f* 86
 Bio-Abfall *m* 61
 biodynamisch 91, 122
 Biologie *f* 162
 biologisch kontrolliert
 118
 Birke *f* 296
 Birma 318
 Birne *f* 60, 127
 bis 320
 Biskuitörtchen *n* 140
 Biss *m* 46
 bitter 124
 bittere Schokolade *f* 113
 Bizeps *m* 16
 Bizepsübung *f* 251
 Blase *f* 46
 Blatt *n* 78, 122, 296
 Blätter *n* 110
 Blätterteig *m* 140
 blau 274
 Blauschimmelkäse *m*
 136
 Blazer *m* 33
 Blechblasinstrumente *n*
 256
 bleifrei 199
 Bleigürtel *m* 239
 Bleistift *m* 163, 275
 Blendenregler *m* 270
 Blinddarm *m* 18
 Blinker *m* 198, 204
 Blitz *m* 270, 287
 Block *m* 237
 blocken 227
 blond 39
 Blues *m* 259
 blühende Pflanze *f* 297
 Blumen *f* 110
 Blumenampel *f* 84
 Blumenarrangements *n*
 111
 Blumenbeet *n* 85, 90
 Blumengeschäft *n* 110
 Blumengirlande *f* 111
 Blumenkohl *m* 124
 Blumentopf *m* 89
 Blumenvase *f* 111
 Bluse *f* 34
 Blutdruck *m* 44
 Blutdruckmesser *m* 45
 Blüte *f* 297
 Blütenblatt *n* 297
 Blutung *f* 46
 Blutuntersuchung *f* 48
- Blutwurst *f* 157
 Bob *m* 247
 Bockshornklee *m* 132
 Boden *m* 85
 Bodenakrobatik *f* 235
 Bodendecker *f* 87
 Bodenturnen *n* 235
 Bogen *m* 85, 164, 249,
 300
 Bogenschießen *n* 249
 Bohnen *f* 131, 144
 bohren 79
 Bohrer *m* 50, 78, 80
 Bohrer mit
 Batteriebetrieb *m* 78
 Bohrfutter *m* 78
 Bohrwinde *f* 78
 Boiler *m* 61
 Boje *f* 217
 Bolivien 315
 Bombenflugzeug *n* 211
 Bonbons *m* 113
 Bongos *m* 257
 Booster *m* 281
 Bordkante *f* 298
 Bordkarte *f* 213
 Börse *f* 97
 Börsenmakler *m* 97
 Bosnien und
 Herzegowina 316
 Botsuana 317
 Boutique *f* 115
 Bowling *n* 249
 Bowlingkugel *f* 249
 Box *f* 268
 Boxen *n* 236
 Boxershorts 33
 Boxgymnastik *f* 251
 Boxhandschuhe *m* 237
 Boxing *m* 237
 Brand *m* 95
 Brandteig *m* 140
 Brandung *f* 241
 Brandungsangeln *n* 245
 Brandwunde *f* 46
 Brasilien 315
 Braten *m* 158
 braten 67
 Bratenblech *n* 69
 bratfertige Huhn *n* 119
 Bratfisch mit Pommes
 frites *m* 155
 Bratpfanne *f* 69
 Bratsche *f* 256
 Brauenbürstchen *n* 40
 braun 274
 braunen Linsen *f* 131
 Brause *f* 89
 breit 321
 Breite *f* 165
 Breitengrad *m* 283
 Bremsbacke *f* 207
 Bremse *f* 200,
 204bremsen 207
 Bremsflüssigkeitsbehälter
 m 202
 Bremshebel *m* 207
 Bremslicht *n* 204

- Bremspedal *n* 205
 Brenner *m* 67
 Brettspiele *n* 272
 Bridge *n* 273
 Brie *m* 142
 Brief *m* 98
 Brieffreund *m* 24
 Briefkasten *m* 58, 99
 Briefmarke *f* 98
 Briefmarken *f* 112
 Briefmarkensammeln *n* 273
 Brieftasche *f* 37
 Briefträger *m* 98, 190
 Briefumschlag *m* 173
 Brille *f* 51
 Brillengestell *n* 51
 Brioche *f* 157
 Brokkoli *m* 123
 Brombeere *f* 127
 Bronze *f* 235
 Brosche *f* 36
 Broschüre *f* 175
 Broschüren *n* 96
 Brot *n* 138, 157
 Brot backen 138
 Brötchen *n* 139, 143, 155
 Brotfrucht *f* 124
 Brotmesser *n* 68
 Brotschneider *m* 139
 browsen 177
 Browser *m* 177
 Bruch *m* 165
 Brücke *f* 300
 Bruder *m* 22
 Brühe *f* 158
 Brunei 319
 brünett 39
 Brunnenkresse *f* 123
 Brust *f* 12, 119
 Brustbein *n* 17
 Brustflosse *f* 294
 Brustkorb *m* 17
 Brustmuskel *m* 16
 Brustpumpe *f* 53
 Brustschwimmen *n* 239
 Brustübung *f* 251
 Brustwarze *f* 12
 Brustwirbel *m* 17
 Brutkasten *m* 53
 Bube *m* 273
 Bubikopf *m* 39
 Buch *n* 168
 Buche *f* 296
 Bücherregal *n* 63, 168
 Buchhaltung *f* 175
 Buchladen *m* 115
 buchstabieren 162
 Buffet *n* 152
 Bug *m* 210, 215, 240
 Bügelbrett *n* 76
 Bügeleisen *n* 76
 bügeln 76
 Bugfahrwerk *n* 210
 Buggy *m* 232
 Bühne *f* 254, 258
 Bühnenbild *n* 254
 Bukett *n* 35, 111
 Bulgarien 316
 Bullauge *n* 214
 Bull's eye *n* 273
 Bund *m* 258
 Bungalow *m* 58
 Bungeejumping *n* 248
 Bunker *m* 232
 Busenbrenner *m* 166
 bunte Mischung *f* 113
 Buntstift *m* 163
 Burg *f* 300
 Bürgersteig *m* 298
 Burggraben *m* 300
 Burkina Faso 317
 Büro *n* 24, 172, 174
 Büroausstattung *f* 172
 Bürobedarf *m* 173
 Bürogebäude *n* 298
 Büroklammer *f* 173
 bürsten 38, 50
 Burundi 317
 Bus *m* 196
 Busbahnhof *m* 197
 Busfahrer *m* 190
 Bushaltestelle *f* 197, 299
 Businessclass *f* 211
 Büstenhalter *m* 35
 Bustier *n* 35
 Bustypen *m* 196
 Butter *f* 137, 156
 Butterfly *m* 239
 Buttermilch *f* 137
 Butternusskürbis *m* 125
 Bytes *n* 176
C
 Caddie *m* 233
 Café *n* 148, 262
 Cafetière *f* 65
 Camcorder *m* 260, 269
 Camembert *m* 142
 Campari *m* 145
 Camping *n* 266
 Campingplatz *m* 266
 Campingplatzverwaltung *f* 266
 Campus *m* 168
 Capoeira *n* 237
 Cappuccino *m* 148
 Cashewnuss *f* 129
 Cashewnüsse *f* 151
 CD-Platte *f* 269
 CD-Spieler *m* 268
 Cello *n* 256
 Champagner *m* 145
 Chassis *n* 203
 Check-up *m* 50
 Cheddar *m* 142
 Cheerleader *m* 220
 Chef *m* 24
 Chemie *f* 162
 Chickensburger *m* 155
 Chicorée *m* 122
 Chile 315
 Chili *m* 132
 China 318
 Chinakohl *m* 123
 chippen 233
 Chips *m* 113
 Chiropraktik *f* 54
 Chirurg *m* 48
 Chirurgie *f* 48
 Chor *m* 301
 Chorizo *f* 143
 Chrysantheme *f* 110
 Chutney *n* 134
 Cockpit *n* 210
 Cocktail *m* 151
 Cocktailrührer *m* 150
 Cocktailshaker *m* 150
 Cola *f* 144
 Collage *f* 275
 Comicheft *n* 112
 Computer *m* 172, 176
 Container *m* 216
 Containerhafen *m* 216
 Containerschiff *n* 215
 Costa Rica 314
 Couchtisch *m* 62
 Countrymusic *f* 259
 Cousin *m* 22
 Creme *f* 109
 Crêpes *f* 155
 Crew *f* 241
 Croissant *n* 156
 Curling *n* 247
 Curry *n* 158
 Currypulver *n* 132
D
 Dach *n* 58, 203
 Dachboden *m* 58
 Dachgarten *m* 84
 Dachgepäckträger *m* 198
 Dachrinne *f* 58
 Dachsparren *m* 186
 Dachvorsprung *m* 58
 Dachziegel *m* 58, 187
 Dame *f* 272, 273
 Damenbinde *f* 108
 Damenkleidung *f* 34
 Damenoberbekleidung *f* 105
 Damensattel *m* 242
 Damenschneiderin *f* 191
 Damenwäsche *f* 105
 Damespiel *n* 272
 Dammschnitt *m* 52
 dämpfen 67
 Dampflokomotive *f* 208
 Dänemark 316
 Darlehen *n* 96
 Darts *n* 273
 Dartscheibe *f* 273
 das Bett machen 71
 das Fruchtwasser geht ab 52
 das Radio einstellen 269
 Datei *f* 177
 Dattel *f* 129
 Datum *n* 306
 Daumen *m* 15
 Deck *n* 214
 Deckanstrich *m* 83
 Decke *f* 62, 71, 74
 Deckel *m* 61, 66, 69
 decken 227
 Degen *m* 236
 Dekoration *f* 141
 Delphin *m* 290
 Deltamuskel *m* 16
 Demokratische Republik Kongo 317
 den Anker werfen 217
 den Ball abgeben 220, 223
 den Fernseher abschalten 269
 den Fernseher einschalten 269
 den Kanal wechseln 269
 den Tisch decken 64
 den Vorsitz führen 174
 den Wecker stellen 71
 Deo *n* 73
 Deos *m* 108
 Dermatologie *f* 49
 Designer *m* 191
 Desinfektionsmittel *n* 51
 Desinfektionstuch *n* 47
 Desktop *n* 177
 Dessertwagen *m* 152
 Deutschland 316
 Dezember *m* 306
 Diagonale *f* 164
 Diamant *m* 288
 Diaphragma *n* 21
 dichte Nebel *m* 287
 Dichtung *f* 61
 Dichtungsring *m* 80
 dick 321
 Dickdarm *m* 18
 dicke Bohne *f* 122
 die Geburt einleiten 53
 Diele *f* 59
 Dienstag *m* 306
 Diesel *m* 199
 Diesellokomotive *f* 208
 digital 179, 269
 Digitale Box *f* 269
 Digitalkamera *f* 270
 Digitalprojektor *m* 163
 Digitalradio *n* 268
 Dill *m* 133
 Dioptrie *f* 51
 Diplom *n* 169
 Dirigent *m* 256
 Diskjockey *m* 179
 Diskuswerfen *n* 234
 diskutieren 163
 Dissertation *f* 169
 Distel *f* 297
 Disziplinen *f* 247
 dividieren 165
 Diwali *n* 27
 Dock *n* 214, 216
 Dokumentarfilm *m* 178
 Dominica 314
 Dominikanische Republik 314
 Domino *n* 273
 Donner *m* 286
 Donnerstag *m* 306
 Doppel *n* 230
 Doppel(haus) 58
 Doppelbett *n* 71
 Doppeldecker *m* 196, 211
 doppelt 151
 Doppelzimmer *n* 100
 Dorf *n* 299
 Dörrrost *n* 156
 Dose *f* 145, 311
 Dosengetränk *n* 154
 Dosenöffner *m* 68
 Dosierung *f* 109
 Dozent *m* 169
 Drachen *m* 248
 Drachenfliegen *n* 248
 Draht *m* 79
 Drahtnetz *n* 167
 Drahtschneider *m* 80
 drechseln 79
 Drehscheibe *f* 275
 Drehstuhl *m* 172
 Drehzahlmesser 201
 drei 308
 Dreieck *n* 164
 Dreifuß *m* 166
 dreihundert 308
 Dreipunktlinie *f* 226
 dreißig 308
 dreißigster 309
 dreistöckige Haus *n* 58
 dreitürig 200
 dreiuinzwanzigster 309
 dreizehn 308
 dreizehnter 309
 Dress *m* 222
 Dressurreiten *n* 243
 dribbeln 223
 dritter 309
 driven 233
 Drucken *n* 275
 drucken 172
 Drucker *m* 172, 176
 Druckfarbe *f* 275
 Druckknopf *m* 30
 Druckluftflasche *f* 239
 Düse *f* 19
 Dschibuti 317
 Duffelcoat *m* 31
 Duftsträußchen *n* 111
 düngen 91
 Dünger *m* 91
 dunkel 41, 321
 Dunkelkammer *f* 271
 dünn 321
 Dünndarm *m* 18
 Dunstabzug *m* 66
 durch 320
 Durchfall *m* 44, 109
 Durchmesser *m* 164
 Durchschwung *m* 233
 Dusche *f* 72
 Duschen *f* 266
 duschen 72
 Duschgel *n* 73
 Duschkopf *m* 72
 Duschtür *f* 72

- Duschvorhang *m* 72
 Düse *f* 89
 Duty-free-Shop *m* 213
 DVD-Platte *f* 269
 DVD-Spieler *m* 268
 Dynamo *m* 207
- E**
- Eau de Toilette *n* 41
 Ebene *f* 285
 EC-Karte *f* 96
 Eckball *m* 223
 Eckfahne *f* 223
 Eckzahn *m* 50
 Eclair *n* 140
 Economyclass *f* 211
 Ecuador 315
 Edamer *m* 142
 Edelstein *m* 36
 Ehefrau *f* 22
 Ehemann *m* 22
 Ei *n* 20
 Eiche *f* 296
 Eichelkürbis *m* 125
 Eichhörnchen *n* 290
 Eidechse *f* 293
 Eier *n* 137
 Eierbecher *m* 65, 137
 Eierschale *f* 137
 Eierstock *m* 20
 Eigeln *n* 137, 157
 Eileiter *m* 20
 Eimer *m* 77, 82, 265
 ein Baby bekommen 26
 ein Feuer machen 266
 ein Rad wechseln 203
 ein Tor schießen 223
 ein Zelt aufschlagen 266
 Einbahn- 194
 Einbahnstraße *f* 298
 Einbauschrank *m* 71
 Einbruchdiebstahl *m* 94
 einchecken 212
 eine halbe Stunde 304
 eine Stelle bekommen 26
 eine Viertelstunde 304
 einen Dunk spielen *m* 227
 einen Flug buchen 212
 einen Rekord brechen 234
 einfach 151
 einfädeln 277
 einfrieren 67
 Eingang *m* 59
 Eingangssperre *f* 209
 eingelegt 159
 eingemachte Obst *n* 134
 einholen 245
 einjährig 86
 Einkauf *m* 104
 Einkaufskorb *m* 106
 Einkaufstasche *f* 106
 Einkaufswagen *m* 106
 Einkaufszentrum *n* 104
 Einlagen *f* 53
 einlochen 233
- einloggen 177
 einlösen 97
 Einmachglas *n* 135
 eins 308
 Einsatzpapier *n* 83
 Einschienenbahn *f* 208
 einschlafen 71
 Einschreiben *n* 98
 Einstand *m* 230
 einstellen 179
 Einstellknopf *m* 167
 Einstellung *f* 203, 271
 eintausend 309
 Eintopf *m* 158
 eintopfen 91
 Eintrittsgeld *n* 260
 einundzwanzig 308
 einundzwanzigster 309
 Einwegkamera *f* 270
 Einwegrasierer *m* 73
 einweichen 130
 Einwickelpapier *n* 111
 Einwurf *m* 223, 226
 einzahlen 96
 Einzahlungsscheine *m* 96
 Einzel *n* 230
 Einzel(haus) 58
 Einzelbett *n* 71
 Einzelzimmer *n* 100
 Einzugsauftrag *m* 96
 Eis *n* 120, 137, 149, 287
 Eis und Zitrone 151
 Eisbär *m* 291
 Eisen *n* 109, 233, 289
 Eisenwarenhandlung *f* 114
 Eisfach *n* 67
 Eisfläche *f* 224
 Eishockey *n* 224
 Eishockeyspieler *m* 224
 Eiskaffee *m* 148
 Eisklettern *n* 247
 Eiskübel *m* 150
 Eiskunstlauf *m* 247
 Eislaufen *n* 247
 Eisprung *m* 20, 52
 Eisschnellauf *m* 247
 Eistee *m* 149
 Eiswürfel *m* 151
 Eiszange *f* 150
 Eiszapfen *m* 287
 Eiweiß *n* 137
 Ekzem *n* 44
 El Salvador 314
 Elefant *m* 291
 Elektriker *m* 188
 elektrische
 Blutdruckmessgerät *n* 45
 elektrische Gitarre *f* 258
 elektrische Schlag *m* 46
 Elektrizität *f* 60
 Elektroartikel *m* 105, 107
 Elektroauto *n* 199
 Elektroböhrer *m* 78
 Elektrokessel *m* 66
 Elektrolokomotive *f* 208
 Elektronenblitz *m* 270
- Elektrorasierer *m* 73
 elf 308
 Elfenbeinküste 317
 Elfmeter *m* 222
 elfter 309
 Ellbogen *m* 13
 Elle *f* 17
 Eltern 23
 E-Mail *f* 98, 177
 E-Mail-Adresse *f* 177
 E-Mail-Konto *n* 177
 Embryo *m* 52
 emigrieren 26
 Empfang *m* 100
 empfangen 20
 Empfängnis *f* 52
 Empfängnisverhütung *f* 21, 52
 Empfangsdame *f* 100, 190
 Empfangshalle *f* 100
 Empfehlungszettel *m* 173
 empfindlich 41
 Emulsionsfarbe *f* 83
 Ende *n* 321
 Endivie *f* 123
 Endlinie *f* 226
 endokrine System *n* 19
 Endokrinologie *f* 49
 Endzone *f* 220
 Energiesparbirne *f* 60
 englische Frühstück *n* 157
 englische Kuchen *m* 140
 englische Senf *m* 135
 Englischhorn *n* 257
 Enkel *m* 22
 Enkelin *f* 22
 Enkelkinder *n* 23
 Entbindung *f* 52
 Entbindungsstation *f* 48, 49
 Ente *f* 119, 185
 Entenei *n* 137
 Entenküken *n* 185
 Entfernung *f* 310
 entgrätet 121
 Enthaarung *f* 41
 enthäutet 121
 Entisolierzange *f* 81
 entlang 320
 entlassen 48
 entschluppt 121
 Entspannung *f* 55
 Entwässerung *f* 91
 entwickeln 271
 Entzündungshemmer *m* 109
 Epilepsie *f* 44
 Erbsen *f* 131
 Erbeben *n* 283
 Erdbeere *f* 127
 Erdbeermilchshake *m* 149
 Erde *f* 85, 280, 282
 Erdgeschoss *n* 104
 Erdkruste *f* 282
- Erdkunde *f* 162
 Erdnuss *f* 129
 Erdnussbutter *f* 135
 Erdnüsse *f* 151
 Erdnussöl *n* 135
 Erdung *f* 60
 Erdzonen *f* 283
 Ereignisse des Lebens *n* 26
 Erfrischungstuch *n* 75
 Ergänzung *f* 55
 Ergebnis *n* 49
 erhalten 177
 Eritrea 317
 Erkältung *f* 44
 Erkennungsetikett *n* 53
 Ermittlung *f* 94
 ernten 91, 183
 Ersatzrad *n* 203
 Ersatzspieler *m* 223
 erschrocken 25
 erste Etage *f* 104
 erste Hilfe *f* 47
 Erste-Hilfe-Kasten *m* 47
 erste Rang *m* 254
 erster 309
 ersticken 47
 ertrinken 239
 eruptiv 288
 Erwachsene *m* 23
 Erweiterung *f* 52
 Esel *m* 185
 Espresso *m* 148
 Essen *n* 64, 75, 149
 essen 64
 Essig *m* 135, 142
 Esskastanie *f* 129
 Essteller *m* 65
 Esszimmer *n* 64
 Estland 316
 Estragon *m* 133
 Eukalyptus *m* 296
 Eule *f* 292
 Europa 316
 Examensarbeit *f* 169
 Exosphäre *f* 286
 externe Festplatte *f* 176
 Extraktion *f* 50
 Eyeliner *m* 40
- F**
- Fabrik *f* 299
 Fach *n* 100
 Facharzt *m* 49
 Fachbereich *m* 169
 Fächerordner *m* 173
 Fachhochschulen *f* 169
 Fadenleiter *m* 276
 Fagott *n* 257
 Fahne *f* 221
 fahrbare Liege *f* 48
 Fähre *f* 215, 216
 fahren 195
 Fahrer *m* 196
 Fahrerkabine *f* 95
 Fahrersitz *m* 196
 Fahrkarte *f* 209
 Fahrkartenschalter *m* 209
- Fahrplan *m* 197, 209, 261
 Fahrpreis *m* 197, 209
 Fahrrad *n* 206
 Fahrradhelm *m* 206
 Fahrradkette *f* 206
 Fahrradlampe *f* 207
 Fahrradständer *m* 207
 Fahrradschloss *n* 207
 Fahrradständer *m* 207
 Fahrradweg *m* 206
 Fahrschein *m* 197
 Fahrstuhl *m* 59, 100, 104
 Fährterminal *m* 216
 Fairway *n* 232
 Falke *m* 292
 Falklandinseln 315
 Fallen *n* 237
 Fallschirm *m* 248
 Fallschirmspringen *n* 248
 Faltbett *n* 266
 Falte *f* 15
 Familie *f* 22
 fangen 220, 225, 227, 229, 245
 Fänger *m* 229
 Fans *m* 258
 Farbe *f* 83, 273
 Farben *f* 274
 Farbton *m* 41
 Farbtopf *m* 83
 Farn *m* 86
 Fasan *m* 119, 293
 Faser *f* 127
 Fassungsvermögen *n* 311
 faul 127
 Faust *f* 15, 237
 Fax *n* 98, 172
 Faxgerät *n* 172
 Februar *m* 306
 Fechten *n* 249
 Feder *f* 163, 293
 Federball *m* 231
 Federhalter *m* 172
 Federmäppchen *n* 163
 Federwaage *f* 166
 fegen 77
 Fehler *m* 230
 Fehlgeburt *f* 52
 Feier *f* 140
 Feige *f* 129
 Feijoa *f* 128
 Feile *f* 81
 feine Nebel *m* 287
 Feinkost *f* 107, 142
 Feld *n* 182, 234, 272
 Feldauslinie *f* 221
 Feldfrucht *f* 183
 Felge *f* 206
 Felgenbremse *f* 206
 Felsen *m* 284
 Fenchel *m* 122, 133
 Fenchelsamen *m* 133
 Feng Shui *n* 55
 Fenster *n* 58, 177, 186, 197, 210
 Fensterladen *m* 58

- Ferkel *n* 185
Fernbedienung *f* 269
Ferglas *n* 281
fernsehen 269
Fernseher *m* 268
Fernsehserie *f* 178, 179
Fernsehstudio *n* 178
Fernsehtelefon *n* 99
Ferse *f* 13, 15
Fertiggerichte *n* 107
Fertigkeiten *f* 79
Fesseln *n* 237
fest 124
Feste *n* 27
feste Honig *m* 134
festlichen Kuchen *m* 141
festmachen 217
Festnahme *f* 94
Feststation *f* 99
Fett *n* 119
fettarme Sahne *f* 137
fettfrei 137
fettig 39, 41
Fettpflanze *f* 87
Fetus *m* 52
feucht 286
Feuchtigkeitsschme *f* 41
Feueranzünder *m* 266
feuerfest 69
Feuerlöscher *m* 95
Feuermelder *m* 95
Feuerstein *m* 288
Feuertreppe *f* 95
Feuerwache *f* 95
Feuerwehr *f* 95
Feuerwehrlaute 95
Feuerwehrmann *m* 189
Feuerzeug *n* 112
Fidschi 319
Fieber *n* 44
Figur *f* 260
Filet *n* 119, 121
filetiert 121
Filialleiter *m* 96
Film *m* 260, 271
Filmfach *n* 270
Filmspule *f* 271
Filter *m* 270
Filterkaffee *m* 148
Filterpapier *n* 167
Finanzberaterin *f* 97
Fingerabdruck *m* 94
Fingerhut *m* 276, 297
Fingernagel *m* 15
Finnland 316
Finsternis *f* 280
Firma *f* 175
Fisch *m* 107, 120
Fische *m* 294
Fischer *m* 189
Fischerboot *n* 217
Fischereihafen *m* 217
Fischfangarten *f* 245
Fischgeschäft *n* 114, 120
Fischhändlerin *f* 188
Fischkorb *m* 245
Fischzucht *f* 183
Fitness *f* 250
Fitnesscenter *n* 250
Fitnessgerät *n* 250
Fitnessraum *m* 101
Flachbildfernseher *m* 269
Fläche *f* 165, 310
flache Ende *n* 239
Flachholzbohrer *m* 80
Flachrennen *n* 243
Flachs *m* 184
Flachzange *f* 80
Fladenbrot *n* 139
Flagge *f* 232
Flamingo *m* 292
Flasche *f* 61, 135, 311
Flaschenöffner *m* 68, 150
Flaschenwasser *n* 144
Flauschdecke *f* 74
Fledermaus *f* 290
Fleisch *n* 119, 124
Fleisch und das Geflügel *n* 106
Fleischerhaken *m* 118
Fleischklopfer *m* 68
Fleischklöße *m* 158
Fleischsorten *f* 119
Flicker *m* 207
Fliege *f* 36, 244, 295
fliegen 211
Fliegenangeln *n* 245
Fließhecklimousine *f* 199
Flipchart *n* 174
Florentiner *m* 141
Flowerhüte 249
Floristin *f* 188
Flosse *f* 290
Flöte *f* 139
Flugbegleiterin *f* 190, 210
Flügel *m* 60, 119, 293
Fluggastbrücke *f* 212
Flughafen *m* 212
Fluginformationsanzeige *f* 213
Flugnummer *f* 213
Flugticket *n* 213
Flugverbindung *f* 212
Flugzeug *n* 210
Flugzeugträger *m* 215
Fluss *m* 284
flüssige Honig *m* 134
Flüssigkeit *f* 77
Flüssigkeitsmaß *n* 311
Flussmündung *f* 285
Fock *f* 240
Fohlen *n* 185
Föhn *m* 38
föhnen 38
Folk *m* 259
Follikel *m* 20
Football *m* 220
Footballspieler *m* 220
Forelle *f* 120
formell 34
Formen *f* 164
Formschnitt *m* 87
Forschung *f* 169
Fortpflanzung *f* 20
Fortpflanzungsorgane *n* 20
Fortpflanzungssystem *n* 19
Foto *n* 271
Fotoalbum *n* 271
Fotoapparatypen *m* 270
Fotofinish *n* 234
Fotogeschäft *n* 115
Fotograf *m* 191
Fotografie *f* 270
fotografieren 271
fotokopieren 272
Fotorahmen *m* 271
Foul *n* 222, 226
Foulinie *f* 229
Foyer *n* 255
Fracht *f* 216
Frachtraum *m* 215
Frachtschiff *n* 215
Frage *f* 163
fragen 163
Fraktur *f* 46
Frankreich 316
französische Senf *m* 135
französischen Bohnen *f* 131
Französisch-Guyana 315
Frau *f* 12, 23
Fräulein *n* 23
Freese *f* 110
frei 321
freigesprochen 181
Freistoß *m* 222
Freitag *m* 306
Freiwurflinie *f* 226
Freizeit *f* 254, 258, 264
Freizeitleidung *f* 33
Fremdenführerin *f* 260
Frequenz *f* 179
Freund *m* 24
Freundin *f* 24
Fries *m* 301
frisch 121, 127, 130
frische Fleisch *n* 142
Frischkäse *m* 136
Friseur *m* 188
Friseurin *f* 38
Frisierartikel *m* 38
Frisiersalon *m* 115
Frisiertisch *m* 71
Frisierumhang *m* 38
Frisure *n* 39
frittiert 159
Frosch *m* 294
Frost *n* 287
Frostschutzmittel *n* 199, 203
Früchtejoghurt *m* 157
Fruchtfleisch *n* 127, 129
Fruchtgummi *m* 113
Fruchtmark *n* 127
Fruchtwasser *n* 52
früh 305
Frühkohl *m* 123
Frühling *m* 307
Frühlingszwiebel *f* 125
Frühstück *n* 64, 156
Frühstücksbuffet *n* 156
Frühstücksspeck *m* 157
Frühstückstablett *n* 101
Frühstückstisch *m* 156
Fuchs *m* 290
Fuchsschwanz *m* 80
Fugenkitt *m* 83
Fühler *m* 295
Führerstand *m* 208
Führung *f* 260
füllen 76
Füller *m* 163
Füllung *f* 140, 155
fünf 308
Fünfeck *n* 164
fünfhundert 308
fünfter 309
fünfundfünfzigtausend-
fünfhundert 309
fünfzehn 308
fünfzehnter 309
fünfzig 308
fünfzigster 309
fünfzigtausend 309
Funkantenne *f* 214
für 320
Furche *f* 183
Fürstentum *n* 315
Fuß *m* 12, 15, 310
Fußabtreter *m* 59
Fußball *m* 222
Fußball *m* 222
Fußballdress *m* 31
Fußballfeld *n* 222
Fußballschuh *m* 223
Fußballspieler *m* 222
Fußboden *m* 62, 71
Fußende *n* 71
Fußgängerüberweg *m* 195
Fußgängerzone *f* 299
Fußpedal *n* 257
Fußrücken *m* 15
Fußschlaufe *f* 241
Fußsohle *f* 15
Fußweg *m* 262
Futter *n* 32
Futteral *n* 51
füttern 183
G
Gabel *f* 65, 88, 153, 207
Gabelstapler *m* 186, 216
Gabun 317
gähnen 25
Galapagosinseln 315
Galaxie *f* 280
Gallone *f* 311
Galopp *m* 243
galvanisiert 79
Gambia 317
Gang *m* 106, 168, 210, 254
Gänge *m* 153, 206
Gans *f* 119, 293
Gänseei *n* 137
ganz 129, 132
Garage *f* 58
Gardine *f* 63
Garn *n* 276
Garnele *f* 121
Garten *n* 84
Gartenanlagen *f* 262
Gartenarbeit *f* 90
Gartencenter *n* 115
Gartengeräte *n* 88
Gartenhandschuhe *m* 89
Gartenkorb *m* 88
Gartenkürbis *m* 124
Gartenornamente *n* 84
Gartenpflanzen *f* 86
Garten-Sauerampfer *m* 123
Gartenschlauch *m* 89
Gartenspritze *f* 89
Gartenstöcke *m* 89
Gartentypen *m* 84
Gärtner *m* 188
Gasbrenner *m* 61, 267
Gashebel *m* 204
Gaspedal *n* 200
Gasse *f* 298
Gast *m* 100
Gästebuch *n* 100
Gastgeber *m* 64
Gastgeberin *f* 64
Gatenummer *f* 213
Gaumen *m* 19
Gaze *f* 47
Gebäck *n* 140, 149
gebacken 159
Gebärmutter *f* 20, 52
Gebärmutterhals *m* 20, 52
Gebäude *n* 299
Gebäudereiniger *m* 188
geben 273
Gebirgskette *f* 282
gebogen 165
geboren werden 26
gebratene Hähnchen *n* 155
Gebrauchsanweisung *f* 109
Gebrauchswarenhändler *m* 115
Geburt *f* 52, 53
Geburtsgewicht *n* 53
Geburtshelfer *m* 52
Geburtstag *m* 27
Geburtstagsfeier *f* 27
Geburtstagskerzen *f* 141
Geburtstagskuchen *m* 141
Geburtsurkunde *f* 26
Geburtszange *f* 53
gedämpft 159
Gedeck *n* 65
Gedänge *n* 221
Gefahr *f* 195
Gefängnis *n* 181
Gefängniswärter *m* 181
Gefängniszelle *f* 181
gefärbt 39

- Geflügel *n* 119
 Gefrierfach *n* 67
 Gefrier-Kühlschrank *m* 67
 Gefrierware *f* 107
 gefrorene Joghurt *m* 137
 Gefühle *n* 25
 gefüllt 159
 gefüllte Fladenbrot *n* 155
 gefüllte Olive *f* 143
 gegenüber 320
 Gegner *f* 236
 gegrillt 159
 Gehalt *n* 175
 gehen lassen 139
 Gehirn *n* 19
 Gehirnerschütterung *f* 46
 Gehrungslade *f* 81
 Geige *f* 256
 Geißblatt *n* 297
 gekochte Ei *n* 137, 157
 gekochte Fleisch *n* 118, 143
 gekrümmt 165
 Gel *n* 109
 geladen 60
 Geländemotorrad *n* 205
 Geländer *n* 59
 Geländewagen *m* 199
 gelangweilt 25
 gelb 274
 gelbe Karte *f* 223
 Geld *n* 97
 Geldautomat *m* 97
 Geldwirtschaft *f* 97
 Geleebonbon *m* 113
 Gelenk *n* 17
 gemahlen 132
 gemahlene Kaffee *m* 144
 Gemälde *n* 62, 261, 274
 gemischte Salat *m* 158
 Gemüse *n* 107, 122, 124
 Gemüsefach *n* 67
 Gemüsegarten *m* 85, 182
 Gemüsehändler *m* 188
 Gemüseladen *m* 114
 Generaldirektor *m* 175
 Generation *f* 23
 Generator *m* 60
 geöffnet 260
 Geometrie *f* 165
 Georgien 318
 Gepäck *n* 100, 198, 213
 Gepäckablage *f* 209
 Gepäckabteilung *f* 104
 Gepäckanhänger *m* 212
 Gepäckausgabe *f* 213
 Gepäckband *n* 212
 Gepäckfach *n* 196, 210
 Gepäckröntgenmaschine *f* 212
 Gepäckträger *m* 204
 Gepäckwaage *f* 212
 gepökelt 118, 143
 gerade 165
 geradeaus 260
 geraspelt 132
 geräuchert 118, 121, 143, 159
 Gerbera *f* 110
 Gerichtsdienst *m* 180
 Gerichtssaal *m* 180
 Gerichtsstenograf *m* 181
 Gerichtstermin *m* 180
 geriebene Käse *m* 136
 geröstet 129
 Gerste *f* 130, 184
 Gerüst *n* 186
 gesalzen 121, 129, 137
 Gesäßmuskeln *m* 16
 Geschäft *n* 175
 Geschäftsabkommen *n* 175
 Geschäftsbogen *m* 173
 Geschäftsfrau *f* 175
 Geschäftsmann *m* 175
 Geschäftspartnerin *f* 24
 Geschäftsreise *f* 175
 geschält 129
 geschälten Garnelen *f* 120
 Geschenk *n* 27
 Geschenkartikelladen *m* 114
 Geschichte *f* 162
 Geschirr *n* 64
 Geschirr und das Besteck *n* 65
 Geschlechtskrankheit *f* 20
 Geschlechtsteile 12
 Geschlechtsverkehr *m* 20
 geschlossen 260, 321
 Geschwindigkeitsbegrenzung *f* 195
 Geschworenen *m* 180
 Geschworenenbank *f* 180
 Gesicht *n* 14
 Gesichtsbildung *f* 41
 Gesichtsschmerz *f* 73
 Gesichtsmaske *f* 41
 Gesichtspuder *m* 40
 Gesichtsschutzmaske *f* 225
 Gesichtswasser *n* 41
 Gesims *n* 300
 gespaltenen Haarspitzen *f* 39
 gestalten 91
 Gestänge *n* 267
 Gestein *n* 288
 Gestell *n* 166, 174
 gestern 306
 Gesundheit *f* 44
 Gesundheitsfürsorge *f* 168
 geteilt durch 165
 getoastete Sandwich *m* 149
 Getränke *n* 107, 144, 156
 Getreide *n* 130
 Getreidefloeken *f* 107, 130, 156
 Getriebe *n* 202, 204
 getrocknet 129, 143, 159
 getrockneten Erbsen *f* 131
 Gewächshaus *n* 85
 Geweih *n* 291
 Gewichte *n* 166, 244
 Gewichte *n* 250
 Gewichthantel *f* 251
 Gewinnanteile *m* 97
 gewinnen 273
 Gewinner *m* 273
 Gewitter *n* 287
 Gewölbe *n* 15, 300
 Gewürze *n* 132
 Gewürzessig *m* 135
 Gewürznelke *f* 133
 Geysir *m* 285
 Ghana 317
 Giebel *m* 300
 Giebeldreieck *n* 301
 gießen 67, 90
 Gießen *n* 89
 Gießkanne *f* 89
 Gin *m* 145
 Gin Tonic *m* 151
 Gips *m* 83
 Giraffe *f* 291
 Girokonto *n* 96
 Gitarrist *m* 258
 Gitterstäbe *m* 74
 Glacière *f* 110
 Glanz- 83
 Glas *n* 51, 134, 152, 311
 Glas- 69
 Gläser *n* 150
 Glasflasche *f* 166
 glasieren 139
 Glaskeramikkochfeld *n* 66
 Glasstäbchen *n* 167
 Glaswaren *f* 64
 glatt 39
 glätten 39
 Glattrochen *m* 294
 gleich 165
 Gleichstand *m* 230
 Gleichstrom *m* 60
 Gleichung *f* 165
 Gleis *n* 208
 Gleisnummer *f* 208
 Gleitschirmfliegen *n* 248
 Gletscher *m* 284
 Glied *n* 36
 Glimmer *m* 289
 glücklich 25
 Glühfaden *m* 60
 Gneis *m* 288
 Gold *n* 235, 289
 Goldfisch *m* 294
 Golf *n* 232
 Golfball *m* 233
 Golferin *f* 232
 Golfhandicap *n* 233
 Golfplatz *m* 232
 Golfschläger *m* 233
 Goltasche *f* 233
 Golfturnier *n* 233
 Gong *m* 257
 Gorilla *m* 291
 gotisch 301
 Gottesanbeterin *f* 295
 GPS-System *n* 201
 graben 90
 graduieren 26
 Graduierte *f* 169
 Graduierungsfeier *f* 169
 Gramm *n* 310
 Granat *m* 288
 Granatapfel *m* 128
 Granit *m* 288
 Grapefruit *f* 126
 Graphit *m* 289
 Gras *n* 86, 262
 Grasfangsack *m* 88
 Grasland *n* 285
 Gräte *f* 121
 grau 39, 274
 Graubrot *n* 139, 149
 graue Star *m* 51
 Gravieren *n* 275
 Greifzange *f* 167
 Grenada 314
 Griechenland 316
 Grieb *m* 130
 Griff *m* 36, 88, 230, 237
 Griffe *m* 37
 Grill *m* 267
 Grillblech *n* 69
 Grille *f* 295
 grillen 67
 Grippe *f* 44
 grobe Senf *m* 135
 Grönland 314
 groß 321
 große Zeh *m* 15
 Großeltern 23
 Großmutter *f* 22
 Großbraunlimousine *f* 199
 Großsegel *m* 240
 Großvater *m* 22
 Grübchen *n* 15
 grün 129, 274
 Grün *n* 232
 Grundfläche *f* 164
 Grundhobel *m* 78
 Grundierfarbe *f* 83
 Grundierung *f* 40, 83
 Grundlinie *f* 230
 Grundriss *m* 261
 grüne Bohne *f* 122
 grüne Erbse *f* 122
 grüne Olive *f* 143
 grüne Salat *m* 158
 grüne Tee *m* 149
 grünen Erbsen *f* 131
 Grünkohl *m* 123
 Gruppentherapie *f* 55
 Guatemala 314
 Guave *f* 128
 Guinea 317
 Guinea-Bissau 317
 Gummiband *n* 173
 Gummihose *f* 30
 Gummiknüppel *m* 94
 Gummistiefel *m* 31, 89
 Gurke *f* 125
 Gürtel *m* 32, 36, 236
 Gürtelschnalle *f* 36
 gut 321
 gut geschnitten 35
 Güterzug *m* 208
 Guyana 315
 Gymnastikband *n* 235
 Gynäkologe *m* 52
 Gynäkologie *f* 49
- ## H
- Haar *n* 14, 38
 Haarband *n* 39
 Haarbürste *f* 38
 Haarfärbemittel *n* 40
 Haarfarben *f* 39
 Haargel *n* 38
 Haarglätter *m* 39
 Haarklammer *f* 38
 Haarknoten *m* 39
 Haarreif *m* 38
 Haarspray *n* 38
 Haarspülung *f* 38
 Hackbrett *n* 68
 Hacke *f* 88
 Hackfleisch *n* 119
 Hackmesser *n* 68
 Hafen *m* 214, 216, 217
 Hafenmeister *m* 217
 Hafer *m* 130
 Haftbefehl *m* 180
 Haftentlassung auf Bewährung *f* 181
 Hagel *m* 286
 Hahn *m* 61, 185
 Hähnchen *n* 119
 Hähnchenstückchen *n* 155
 Hahnenfuß *m* 297
 Haifisch *m* 294
 Haiti 314
 Häkelhaken *m* 277
 Häkeln *n* 277
 Haken *m* 187, 276
 halbdunkle Bier *n* 145
 halbe Liter *m* 311
 halbfeste Käse *m* 136
 Halbfettmilch *f* 136
 Halbinsel *f* 282
 Halbpension *f* 101
 Halbzeit *f* 223
 Halfter *n* 243
 Halloween *n* 27
 Hals *m* 12, 258
 Halskette *f* 36
 Halskrawatte *f* 46
 Halspastille *f* 109
 Halstuch *n* 36
 Halswirbel *m* 17
 Haltegriff *m* 196
 Halteknopf *m* 197
 halten 223
 Halten verboten 195
 Haltung *f* 232

- Hämätit *m* 289
 Hamburger *m* 154
 Hamburger mit Pommes frites *m* 154
 Hammer *m* 80
 hämmern 79
 Hamster *m* 290
 Hand *f* 13, 15
 Handbohrer *m* 81
 Handbremse *f* 203
 Handfeger *m* 77
 Handfläche *f* 15
 Handgabel *f* 89
 Handgelenk *n* 13, 15
 Handgepäck *n* 211, 213
 Handknöchel *m* 15
 Handrad *n* 276
 Handsäge *f* 89
 Handschellen *f* 94
 Handschuh *m* 224, 228, 233, 236, 246
 Handschuhe *m* 36
 Handtasche *f* 37
 Handtuch *n* 73
 Handtücher *n* 73
 Handtuchhalter *m* 72
 Handy *n* 99
 Hang *m* 284
 Hängematte *f* 266
 Hängeordner *m* 173
 Hantel *f* 251
 Hardware *f* 176
 Harfe *f* 256
 harken 90
 Harnblase *f* 20
 Harnleiter *m* 21
 Harnröhre *f* 20
 Harnsystem *n* 19
 hart 129, 321
 Hartfaserplatte *f* 79
 Hartholz *n* 79
 Hartkäse *m* 136
 Haselnuss *f* 129
 Haselnussöl *n* 134
 Hauptfahrwerk *n* 210
 Hauptgericht *n* 153
 Hauptmahlzeit *f* 158
 Hauptstadt *f* 315
 Haus *n* 58
 Hausanschlüsse *m* 60
 Hausapotheke *f* 72
 Hausaufgaben *f* 163
 Haushaltswaage *f* 69
 Haushaltswaren *f* 107
 Hausschuhe *m* 31
 Haustür *f* 58
 Hausturlampe *f* 58
 Haut *f* 14, 119
 Hautausschlag *m* 44
 Hautpflege *f* 108
 Hawaii 314
 Heavymetal *n* 259
 Hebamme *f* 53
 Hebel *m* 61, 150
 Heck *n* 198, 210, 240
 Hecke *f* 85, 90, 182
 Heckenschere *f* 89
 Hefe *f* 138
 Hefebrötchen *n* 139
 Heft *n* 163
 heften 277
 Hefter *m* 173
 hegen 91
 Heidekraut *n* 297
 Heidelbeere *f* 127
 Heilbuttflets *n* 120
 Heilkräuter *n* 55
 Heimwerkstatt *f* 78
 heiraten 26
 heiß 286, 321
 heiße Schokolade *f* 144
 heißen Getränke *n* 144
 Heißluftballon *m* 211
 Heißwasserhahn *m* 72
 Heizdecke *f* 71
 Heizelement *n* 61
 Heizkörper *m* 60
 Heizlüfter *m* 60
 Heizofen *m* 60
 Heizungsregler *m* 201
 hell 41, 321
 Helm *m* 204, 220, 228
 Hemd *n* 33, 251
 Henkel *m* 106
 Herbizid *n* 183
 Herbst *m* 31, 307
 Herde *f* 183
 Hering *m* 266
 Herr *m* 23
 Herrenbekleidung *f* 105
 Herrenfriseur *m* 39
 Herrenhalbschuh *m* 37
 Herrenkleidung *f* 32
 herunterladen 177
 Herz *n* 18, 119, 122, 273
 Herz- und Gefäßsystem *n* 19
 Herzinfarkt *m* 44
 Herzmuskel *f* 121
 Heu *n* 184
 Heuschupfen *m* 44
 Heuschrecke *f* 295
 heute 306
 Lieb *m* 237
 hier essen 154
 Hi-Fi-Anlage *f* 268
 Hilfskoch *m* 152
 Himalaja *m* 313
 Himbeere *f* 127
 Himbeerkonfitüre *f* 134
 hinauf 320
 Hindernis *n* 243
 hinter 320
 Hinterbacke *f* 13
 hinterherlaufen 229
 Hinterrad *n* 197
 hinunter 320
 Hirsch *m* 291
 Hirse *f* 130
 historische Gebäude *n* 261
 HNO-Abteilung *f* 49
 Hobel *m* 81
 hobeln 79
 hoch 271, 321
 hochauflösend 269
 hochbinden 91
 Hochfrisur *f* 39
 Hochgeschwindigkeitszug *m* 208
 Hochglanz- 271
 Hochschule *f* 168
 Hochseefischerei *f* 245
 Hochsprung *m* 235
 Höchstlademarke *f* 214
 Hochzeit *f* 26, 35
 Hochzeitsfeier *f* 26
 Hochzeitskleid *n* 35
 Hochzeitsreise *f* 26
 Hochzeitstag *m* 26
 Hochzeitstorte *f* 141
 hochziehen 251
 Höcker *m* 291
 Hockey *n* 224
 Hockeyball *m* 224
 Hockeyschläger *m* 224
 Hoden *m* 21
 Hodensack *m* 21
 Hof *m* 58, 84, 182
 Höhe *f* 165, 211
 Höhenleitwerk *n* 210
 Höhle *f* 284
 Hole-in-One *n* 233
 Holz *n* 79, 233, 275
 Holzarbeit *f* 275
 Holzblasinstrumente *n* 257
 Holzbohrer *m* 80
 Holzkohle *f* 266
 Holzleim *m* 78
 Holzlöffel *m* 68
 Holzspäne *m* 78
 homogenisiert 137
 Homöopathie *f* 55
 Honduras 314
 Honigwabe *f* 135
 Hörer *m* 99
 Hormon *n* 20
 Horn *n* 257, 291
 Hornhaut *f* 51
 Horrorfilm *m* 255
 Hörsaal *m* 169
 Hose *f* 32, 34
 Hot Dog *n* 155
 Hotel *n* 100, 264
 Hoteldiener *m* 100
 Hubschrauber *m* 211
 Huf *m* 242, 291
 Hufeisen *n* 242
 Hüfte *f* 12
 Hügel *m* 284
 Huhn *n* 185
 Hüchnerbein *n* 119
 Hühnererei *n* 137
 Hühnerfarm *f* 183
 Hühnerstall *m* 185
 Hülse *f* 130
 Hülsenfrüchte *f* 130
 Hummer *m* 121, 295
 Hund *m* 290
 hundert 308
 hundertster 309
 hunderttausend 308
 hundertzehn 308
 Hundeschlittensfahren *n* 247
 hungrig 64
 Hupe *f* 201, 204
 Hürdenlauf *m* 235
 Hurrikan *m* 287
 Husten *m* 44
 Hustenmedikament *n* 108
 Hut *m* 36
 Hüttenkäse *m* 136
 Hydrant *m* 95
 Hypnotherapie *f* 55
 hypoallergen 41
 Hypotenuse *f* 164
 Hypothek *f* 96
- I**
 Igel *m* 290
 Imbissstand *m* 154
 Imbissstube *f* 154
 immergrün 86
 Immobilienmakler *m* 115
 Immobilienmaklerin *f* 189
 impotent 20
 in 320
 in den Ruhestand treten 26
 indigoblau 274
 in Ei gebratene Brot *n* 157
 in Lake 143
 in Ohnmacht fallen 25, 44
 in Öl 143
 in Saft 159
 in Sicherheit 228
 in Soße 159
 Inbox *f* 177
 Indien 318
 Indische Ozean *m* 312
 Indonesien 319
 Industriegebiet *n* 299
 Infektion *f* 44
 Information *f* 261
 Ingwer *m* 125, 133
 Inhalationsapparat *m* 44
 Inhalierstift *f* 109
 Inlandsflug *m* 212
 Inlinerfahren *n* 263
 Inlineskaten *n* 249
 Innenausstattung *f* 200
 Innenfeld *n* 228
 innere Kern *m* 282
 Innereien 320
 innerhalb 318
 Inning *n* 228
 ins Bett gehen 71
 Insektenschutzmittel *n* 108
 Insektenspray *m* 267
 Insel *f* 282
 Inspektor *m* 94
 Installation *f* 61
 installieren 177
 Instrumente *n* 258
 Insulin *n* 109
 Intensivstation *f* 48
- J**
 Jacht *f* 215
 Jacke *f* 32, 34
 Jade *m* 288
 Jagdflugzeug *n* 211
 Jagdrennen *n* 243
 Jahr *n* 306
 Jahreszeiten *f* 306
 Jahrhundert *n* 307
 jährlich 307
 Jahrmärkte *m* 262
 Jahrtausend *n* 307
 Jahrzehnt *n* 307
 Jakobsmuschel *f* 121
 Jalousie *f* 63
 Jamaika 314
 Jamswurzel *f* 125
 Januar *m* 306
 Japan 318
 jäten 91
 Jazz *m* 259
 Jeans *f* 31, 33
 Jemen 318
 jenseits 320
 Jett *m* 288
 jetzt
 Jogging *n* 251, 263
 Joghurt *m* 137
 Joker *m* 273
 Jordanien 318
 Journalist *m* 190
 Judo *n* 236
 Jugendliche *f* 23
 Jugendstil *m* 301
 Jugoslawien 316
 Juli *m* 306
 Junge *m* 23, 290
 Juni *m* 306
 Jupiter *m* 280
 Juwelier 188
 Juwelierarbeit *f* 275
 Juweliergeschäft *n* 114
- K**
 Kabel *n* 79, 207
 Kabelfernsehen *n* 269
 Kabeljau *m* 120
 Kabinda 317
 Kabine *f* 210, 214
 Kabinenlift *m* 246
 Kariolett *n* 199
 kacheln 82

- Käfer *m* 295
 Kaffee *m* 144, 148, 153, 156, 184
 Kaffee mit Milch *m* 148
 Kaffeelöffel *m* 153
 Kaffeemaschine *f* 148, 150
 Kaffeemilchshake *m* 149
 Kaffeetasse *f* 65
 kahl 39
 Kai *m* 216
 Kaiserschnitt *m* 52
 Kakadu *m* 293
 Kakaopulver *n* 148
 Kakerlak *m* 295
 Kaktus *m* 87
 Kaktusfeige *f* 128
 Kalb *n* 185
 Kalbfleisch *n* 118
 Kalender *m* 306
 Kalk *m* 85
 Kalkstein *m* 288
 kalt 286, 321
 kaltgepresstes Öl *n* 135
 Kaltwasserhahn *m* 72
 Kalzit *m* 289
 Kalzium *n* 109
 Kambodscha 318
 Kamel *n* 291
 Kamera *f* 178, 260
 Kamera-Handy *n* 270
 Kamerakran *m* 178
 Kameramann *m* 178
 Kameratasche *f* 271
 Kamerun 317
 Kamillentee *m* 149
 Kamin *m* 63
 Kamm *m* 38
 kämmen 38
 Kammer *f* 283
 Kampf *m* 237
 Kampfsport *m* 236
 Kampfsportarten *f* 237
 Kanada 314
 Kanal *m* 178, 269, 299
 Kanalschacht *m* 299
 Kanarienvogel *m* 292
 Kandare *f* 242
 kandierten Früchte *f* 129
 Känguru *n* 291
 Kaninchen *n* 118, 290
 Kännchen *n* 65
 Kante *f* 246
 Kanter *m* 243
 Kanu *n* 214
 Kanusport *m* 241
 Kapern *f* 143
 Kapitalanlage *f* 97
 Kapitän *m* 214
 Kapsel *f* 109
 Kapstachelbeere *f* 128
 Kapuze *f* 31
 Kapuzenmuskel *m* 16
 Karamell *m* 113
 Karamellpudding *m* 142
 Karate *n* 236
 Kardamom *m* 132
 Kardanwelle *f* 202
 Kardiologie *f* 49
 Karibische Meer *n* 312
 Karies *f* 50
 Karneval *m* 27
 Karo *n* 273
 Karosserie *f* 202
 Karotte *f* 124
 Karte *f* 27
 Karten *f* 273
 Kartenreiter *m* 173
 Kartenschlitz *m* 97
 Kartenspiel *n* 273
 Kartoffel *f* 124
 Kartoffelchips *m* 151
 Kartoffelstampfer *m* 68
 Kasachstan 318
 Käse *m* 136, 156
 Kasino *n* 261
 Kaspische Meer *n* 313
 Kasse *f* 106, 150, 255
 Kasserolle *f* 69
 Kassettenrekorder *m* 269
 Kassierer *m* 96, 106
 Katamaran *m* 215
 Katar 318
 Kathedrale *f* 300
 Katheter *m* 53
 Kätzchen *n* 290
 Katze *f* 290
 Katzenauge *n* 204
 Kaufhaus *n* 105
 Kaugummi *m* 113
 Kaulquappe *f* 294
 Kaution *f* 181
 Kajak *n* 241
 Kebab *m* 155
 Kegel *m* 164, 249
 Kehdeckel *m* 19
 Kehle *f* 19
 Kehlkopf *m* 19
 Kehre *f* 238
 Keilriemen *m* 203
 Keilschuh *m* 37
 keine Einfahrt 195
 Keks *m* 113, 141
 Kelch *m* 297
 Kelle *f* 187
 Kellergeschoss *n* 58
 Kellner *m* 148, 152
 Kellnerin *f* 191
 Kendo *n* 236
 Kenia 317
 Kennmarke *f* 94
 kentern 241
 Kern *m* 122, 127, 128, 129, 130
 Kerngehäuse *n* 127
 kernlos 127
 Kescher *m* 244
 Kessel *m* 61
 Kesselpauke *f* 257
 Ketchup *m* 135
 Kette *f* 36
 Kettenzahnrad *n* 207
 Keule *f* 119, 167, 228
 Keyboard *n* 258
 Kichererbsen *f* 131
 Kickboxen *n* 236
 kicken 221, 223
 Kiefer *f* 296
 Kieferknochen *m* 17
 Kiel *m* 214
 Kieme *f* 294
 Kies *m* 88
 Kilogramm *n* 310
 Kilometer *m* 310
 Kilometerzähler *m* 201
 Kind *n* 23, 31
 Kinder *n* 23
 Kinderabteilung *f* 104
 Kinderbett *n* 74
 Kinderkleidung *f* 30
 Kinderportion *f* 153
 Kindersicherung *f* 75
 Kindersitz *m* 198, 207
 Kinderstation *f* 48
 Kinderstuhl *m* 75
 Kinderwagen *m* 75
 Kinderzimmer *n* 74
 Kinn *n* 14
 Kinnlade *f* 14
 Kino *n* 255, 299
 Kinosaal *m* 255
 Kipper *m* 187
 Kirche *f* 298, 300
 Kirgisistan 318
 Kirsche *f* 126
 Kirschtomate *f* 124
 Kissenbezug *m* 71
 Kiwi *f* 128
 Klammer *f* 166
 Klammern *f* 173
 Klampe *f* 240
 Klappe *f* 179
 Klappstisch *m* 210
 Klarinette *f* 257
 Klasse *f* 163
 Klassenzimmer *n* 162
 klassische Musik *f* 255, 259
 klassizistisch 301
 Klatschmohn *m* 297
 Klaue *f* 291
 Klavier *n* 256
 Klebstoff *m* 275
 Klee *m* 297
 Kleid *n* 31, 34
 Kleiderbügel *m* 70
 Kleiderschrank *m* 70
 Kleidung *f* 205
 Kleie *f* 130
 klein 321
 Kleinbus *m* 197
 kleine Finger *m* 15
 kleine Trommel *f* 257
 kleine Zahn *m* 15
 Kleinkind *n* 30
 Kleisterbürste *f* 82
 Klementine *f* 126
 Klemmbrett *n* 173
 Klempner *m* 188
 Klettergerüst *n* 263
 Klettern *n* 248
 Kletterpflanze *f* 87
 Klient *m* 180
 Klimaanlage *f* 200
 Klinge *f* 89
 Klingel *f* 197
 Klinik *f* 48
 Klippe *n* 285
 Klitoris *f* 20
 Klöppel *m* 277
 Klubhaus *n* 232
 Klubsandwich *m* 155
 Knabberien *f* 151
 Knäckebrot *n* 139, 156
 knackig 127
 Knebelknopf *m* 31
 kneten 138
 Knie *n* 12
 Kniebeuge *f* 251
 knielang 34
 Kniescheibe *f* 17
 Knieschützer *m* 205, 227
 Kniesehenstrang *m* 16
 Knoblauch *m* 125, 132
 Knoblauchpresse *f* 68
 Knöchel *m* 13, 15
 knöchellang 34
 Knochen *m* 17, 119
 Knochenasche *f* 88
 Knockout *m* 237
 Knopf *m* 32
 Knopfloch *n* 32
 Knorpel *m* 17
 Knospe *f* 111, 297
 Koalabär *m* 291
 Koch *m* 190
 köcheln lassen 67
 kochen 67
 Kochen *n* 67
 Köcher *m* 249
 Kochfeld *n* 67
 Kochmütze *f* 190
 Kochtopf *m* 69
 Köder *m* 244
 Köderhaken *m* 244
 ködern 245
 Kofferkuli *m* 100, 208, 213
 Kofferraum *m* 198
 Kohl *m* 123
 Kohle *f* 288
 Kohlestift *m* 275
 Kohlrabi *m* 123
 Kohlrübe *f* 125
 Koikarpfen *m* 294
 Kokon *m* 295
 Kokosnuss *f* 129
 Kolben *m* 166
 Kolibri *m* 292
 Kollege *m* 24
 Kolonie 315
 Kolumbien 315
 Kombinationszange *f* 80
 Kombiwagen *m* 199
 Kombüse *f* 214
 Komet *m* 280
 Kommandobrücke *f* 214
 Kommandoturm *m* 215
 Kommode *f* 70
 Kommunikation *f* 98
 Komödie *f* 255
 Komoren 317
 Kompass *m* 240, 312
 Komposterde *f* 88
 Komposthaufen *m* 85
 Kondensmilch *f* 136
 Konditor *m* 113
 Konditorcreme *f* 140
 Konditorei *f* 114
 Kondom *n* 21
 Konfitüre *f* 134, 156
 Konglomerat *n* 288
 Kongo 317
 König *m* 272, 273
 Königsberg 316
 Konserven *f* 107
 Konsultation *f* 45
 Kontaktlinsen *f* 51
 Kontaktlinsenbehälter *m* 51
 Kontinent *m* 282, 315
 Kontonummer *f* 96
 Kontoüberziehung *f* 96
 Kontrabass *m* 256
 Kontrafagott *n* 257
 Kontrollturm *m* 212
 Konzert *n* 255, 258
 Kopf *m* 12, 19, 112, 230
 köpfen 91, 222
 Kopfende *n* 70
 Kopfhaut *f* 39
 Kopfhörer *m* 268
 Kopfkissen *n* 70
 Kopfschmerzen *m* 44
 Kopfschutz *m* 74, 236
 Kopfstütze *f* 200
 Kopfverletzung *f* 46
 kopieren 172
 Kopilot *m* 211
 Koppel *f* 242
 Korallenriff *n* 285
 Korb *m* 207, 226
 Korbbrett *n* 226
 Körbchen *n* 74
 Korbiring *m* 226
 Koriander *m* 133
 Korinthe *f* 129
 Korken *m* 134
 Korkenzieher *m* 150
 Körner *n* 131
 Körnerbrot *n* 139
 Körper *m* 12, 164
 Körperlotion *f* 73
 Körperpuder *m* 73
 Körpersysteme *n* 19
 Körperverletzung *f* 94
 Korrekturstift *m* 40
 Korsett *n* 35
 Korsika 316
 Kotelett *n* 119
 Krabbe *f* 121
 Kraftstoffanzeige *f* 201
 Kraftstofftank *m* 204
 Krafttraining *n* 251
 Kragen *m* 32
 Krähe *f* 292
 Kralle *f* 293

- Krampf *m* 239
 Krämpfe *m* 44
 Kran *m* 187, 216
 Kranich *m* 292
 Krankenhaus *n* 48
 Krankenhausstation *f* 48
 Krankenschwester *f* 45, 48, 52, 189
 Krankenwagen *m* 94
 Krankheit *f* 44
 Kranz *m* 111
 Krater *m* 283
 kratzen *vt* 77
 Kraulen *n* 239
 kraus *adj* 39
 Kraut *n* 86
 Kräuter *n* 133, 134
 Kräuter und Gewürze *n* 132
 Kräutergarten *m* 84
 Kräuterheilkunde *f* 55
 Kräuterheilmittel *n* 108
 Kräutermischung *f* 132
 Kräutertee *m* 149
 Krawatte *f* 32
 Krawattennadel *f* 36
 Krebs *m* 121, 295
 Kreditkarte *f* 96
 Kreide *f* 162, 288
 Kreis *m* 165
 Kreissäge *f* 78
 Kreisverkehr *m* 195
 Kreuz *n* 13, 256, 273
 Kreuzblume *f* 300
 Kreuzkümmel *m* 132
 Kreuzschlitzschraubenzieher *m* 80
 Kreuzung *f* 194, 298
 Cricket *n* 225
 Cricketball *m* 225
 Cricketspieler *m* 225
 Cricketer *n* 225
 Kriechpflanze *f* 87
 Kriegsschiff *n* 215
 Kriminalbeamte *m* 94
 Kristalltherapie *f* 55
 Kroatien *n* 316
 Krokodil *n* 293
 Krokodilklemme *f* 167
 Krone *f* 50
 Kröte *f* 294
 Krug *m* 151
 Kruste *f* 139
 Kuba *n* 314
 Küche *f* 66, 152
 Kuchen *m* 141
 Kuchen backen *vt* 69
 Kuchenblech *n* 69
 Küchenchef *m* 152
 Kuchenform *f* 69
 Küchengeräte *n* 66, 68, 105
 Küchenmaschine *f* 66
 Küchenmesser *n* 68
 Küchenregal *n* 66
 Küchenschrank *m* 66
 Kugel *f* 149, 164
 Kugelstoßen *n* 234
 Kuh *f* 185
 Kühler *m* 202
 Kühlmittelbehälter *m* 202
 Kühschrank *m* 67
 Kuhmilch *f* 136
 Küken *n* 185
 Kulisse *f* 254
 Kultivator *m* 182
 Kümmel *m* 131
 Kumquat *f* 126
 Kunde *m* 96, 104, 106, 152
 Kundendienst *m* 104
 Kundendienstabteilung *f* 175
 Kundin *f* 38, 175
 Kung-Fu *n* 236
 Kunst *f* 162
 Kunstgalerie *f* 261
 Kunstgeschichte *f* 169
 Kunsthandlung *f* 115
 Kunsthandwerk *n* 274, 276
 Kunsthochschule *f* 169
 Künstlerin *f* 274
 kunststoffbeschichtet *adj* 69
 Kupfer *n* 289
 Kuppel *f* 300
 Kupplung *f* 200, 204
 Kürbiskern *m* 131
 Kurierdienst *m* 99
 Kurkuma *f* 132
 kurz *adj* 32, 321
 kurz gebraten *adj* 159
 Kurzhaarschnitt *m* 39
 Kurzsichtigkeit *f* 51
 Kurzwaren *f* 105
 Kurzwelle *f* 179
 Kuschtier *n* 75
 Kuskus *m* 130
 Küste *f* 285
 Küstenwache *f* 217
 Kuwait *n* 318
- L**
 Labor *n* 166
 Laborwaage *f* 166
 lächeln *vi* 25
 lachen *vi* 25
 Lachs *m* 120
 Lack *m* 79, 83
 Lacrosse *n* 249
 Lacrosseschläger *m* 249
 Laden *m* 298
 Lagerfeuer *n* 266
 Laib *m* 139
 Laken *n* 74
 Lakritze *f* 113
 Laktose *f* 137
 Lamm *n* 118, 185
 Lampe *f* 62
 Lampen *f* 105
 Land *n* 282, 315
 landen *vt* 211
 Landschaft *f* 284
 Landungsbrücke *f* 214
 Landungssteg *m* 217
 landwirtschaftlichen Betriebe *m* 183
 lang *adj* 32
 Länge *f* 165, 310
 Längengrad *m* 283
 Langkorn- *n* 130
 Langlauf *m* 247
 Langlaufmaschine *f* 250
 langsam *adj* 321
 Längsschnitt *m* 282
 Langwelle *f* 179
 Laos *n* 318
 Laptop *m* 175, 176
 Lärche *f* 296
 Lastwagen *m* 194
 Lastwagenfahrer *m* 190
 Laterne *f* 217
 Latte *f* 235
 Lätzchen *n* 30
 Latzhose *f* 30
 Laubbaum *m* 86
 Laubrechen *m* 88
 Lauch *m* 125
 Lauf *m* 228
 Laufband *n* 106, 250
 Läufer *m* 272
 Laufstall *m* 75
 Lautsprecher *m* 176, 209, 258
 Lautstärke *f* 179, 269
 Lava *f* 283
 Lawine *f* 247
 Leadsänger *m* 258
 Lebensmittel *n* 106
 Lebensmittelabteilung *f* 105
 Lebensmittelgeschäft *n* 114
 Leber *f* 18, 118
 Lederanzug *m* 205
 Lederschuhe *m* 32
 leer *adj* 321
 Leerung *f* 98
 legen *vt* 38
 leger *adj* 34
 Leggings *f* 31
 Leguan *m* 293
 Lehm *m* 85
 Lehne *f* 64
 Lehrerin *f* 162, 191
 leicht *adj* 321
 Leichtathlet *m* 234
 Leichtathletik *f* 234
 Leichtflugzeug *n* 211
 Leimpistole *f* 78
 Leinen *n* 277
 Leinwand *f* 255, 274
 Leiste *f* 12
 leitende Angestellte *m* 174
 Leiter *f* 95, 186
 Leitkegel *m* 187
 Leitplanke *f* 195
 Leitung *f* 60
 Leitungswasser *n* 144
 Leitz-Ordner *m* 173
 Lende *f* 121
 Lendensteak *n* 119
 Lendenwirbel *m* 17
 Lenkrad *n* 201
 Lenkstange *f* 207
 lernen *vt* 163
 Lernen *n* 162
 Leselampe *f* 210
 lesen *vt* 162
 Leserausweis *m* 168
 Lesesaal *m* 168
 Lesotho *n* 317
 Lettland *n* 316
 letzte Woche *n* 307
 Leuchtrakete *f* 240
 Leuchtbalken *m* 205
 Leuchtturm *m* 217
 Leukoplast *n* 47
 Levkoje *f* 110
 Lexikon *n* 163
 Libanon *n* 318
 Libelle *f* 295
 Liberia *n* 317
 Libyen *n* 317
 Licht *n* 94
 Lichtmaschine *f* 203
 Lichtschalter *m* 201
 Lid *n* 51
 Lidschatten *m* 40
 Liebesfilm *m* 255
 Liechtenstein *n* 316
 Lied *n* 259
 Lieferung ins Haus *f* 154
 Liegestuhl *m* 265
 Liegestütz *m* 251
 Liga *f* 223
 Likör *m* 145
 Lilie *f* 110
 Limonade *f* 144
 Limone *f* 126
 Limousine *f* 199
 Linde *f* 296
 Lineal *n* 163, 165
 Linien *f* 165
 Liniennummer *f* 196
 Liniennummer *n* 220, 223, 230
 Liniensystem *n* 256
 linke Feld *n* 228
 links *adv* 260
 Linkssteuerung *f* 201
 Linse *f* 51, 270
 Lipgloss *m* 40
 Lippe *f* 14
 Lippenkonturenstift *m* 40
 Lippenpinsel *m* 40
 Lippenstift *m* 40
 Litauen *n* 316
 Liter *m* 311
 Literatur *f* 162, 169
 Literaturliste *f* 168
 Litschi *f* 128
 live *adv* 178
 Lob *m* 230
 Loch *n* 232
 Locher *m* 173
 Lockenstab *m* 38
 Löffel *m* 65
 Löffelbiskuits *n* 141
 Loganbeere *f* 127
 Loge *f* 254
 Logo *n* 31
 Lohnliste *f* 175
 Lokomotive *f* 208
 Lorbeerblatt *n* 133
 Löschfahrzeug *n* 95
 loslassen *vt* 245
 löslich *adj* 109
 Lösungsmittel *n* 83
 löten *vt* 79
 Lotion *f* 109
 Lötkolben *m* 81
 Lottoscheine *m* 112
 Lötzinn *m* 79, 80
 Löwe *m* 291
 Löwenzahn *m* 123, 297
 Luffaschwamm *m* 73
 Luftdüse *f* 210
 Luftfilter *m* 202, 204
 Luftkissenboot *n* 215
 Luftmanschette *f* 45
 Luftmatratze *f* 267
 Luftpostbrief *m* 98
 Luftpumpe *f* 207
 Luftröhre *f* 18
 Lunge *f* 18
 Lungenautomat *m* 239
 Lupinen *f* 297
 Lutscher *m* 113
 Luxemburg *n* 316
 Luzerne *f* 184
 lymphatische System *n* 19
- M**
 Macadamianuss *f* 129
 Madagaskar *n* 317
 Mädchen *n* 23
 Magen *m* 18
 Magenschmerzen *m* 44
 magere Fleisch *n* 118
 Magermilch *f* 136
 Magister *m* 169
 Magma *n* 283
 Magnesium *n* 109
 Magnet *m* 167
 Mährescher *m* 182
 mähen *vt* 90
 Mähne *f* 242, 291
 Mai *m* 306
 Mais *m* 122, 124, 130, 184
 Maisbrot *n* 139
 Maiskeimöl *n* 135
 Majonäse *f* 135
 Majoran *m* 133
 Make-up *n* 40
 Makramée *n* 277
 Makrele *f* 120
 Mal *n* 229
 mal *adv* 165
 Malachit *m* 288
 Malawi *n* 317
 Malaysia *n* 318
 Malediven *n* 318
 Malerei *f* 274
 Malerin *f* 191
 Mali *n* 317

- Malspieler *m* 228
 Malta 316
 Malzessig *m* 135
 Malzgetränk *n* 144
 Manager *m* 174
 Manchego *m* 142
 Mandarine *f* 126
 Mandel *f* 129
 Mandeln *f* 151
 Mandelöl *n* 134
 Mango *f* 128
 Mangold *m* 123
 Maniküre *f* 41
 Maniok *m* 124
 Mann *m* 12, 23
 männlich 21
 Mannschaft *f* 220
 Mansarde *f* 58
 Mansardenfenster *n* 58
 Manschette *f* 32
 Manschettenknopf *m* 36
 Mantel *m* 32, 282
 Maracas *f* 257
 Marathon *m* 234
 Margarine *f* 137
 Margerite *f* 110, 297
 Marienkäfer *m* 295
 Marina *f* 217
 mariniert 143, 159
 Marketingabteilung *f* 175
 Markise *f* 148
 Markt *m* 115
 Marmor *m* 288
 Marokko 317
 Mars *m* 280
 Marshmallow *n* 113
 Martini *m* 151
 März *m* 306
 Marzipan *n* 141
 Maschinen *f* 187
 Maschinenbau *m* 169
 Maschinengewehr *n* 189
 Maschinenraum *m* 214
 Masern *f* 44
 Maske *f* 189, 236, 249
 Maß *n* 150, 151
 Massage *f* 54
 Maße *n* 165
 Mast *m* 240
 Mastdarm *m* 21
 Match *n* 230
 Material *n* 187
 Materialien *n* 79
 Mathematik *f* 162, 164
 Matratze *f* 70, 74
 matt 83, 271
 Matte *f* 54, 235
 Mauer *f* 58, 186, 222
 Mauerturm *m* 300
 Mauerwerkbohrer *m* 80
 Mauretania 317
 Mauritius 317
 Maus *f* 176, 290
 Mautstelle *f* 194
 Mazedonien 316
 MDF-Platte *f* 79
 Mechanik *f* 202
 Mechaniker *m* 188, 203
 Medaillen *f* 235
 Medien *f* 178
 Medikament *n* 109
 Meditation *f* 54
 Medizin *f* 169
 Meer *n* 264, 282
 Meeresfrüchte *f* 121
 Meerrettich *m* 125
 Mehl *n* 138
 Mehl mit Backpulver *n* 139
 Mehl ohne Backpulver *n* 139
 mehrjährig 86
 Mehrkornbrot *n* 139
 Meile *f* 310
 Meißel *m* 81, 275
 Meisterschaft *f* 230
 melken 183
 Melodie *f* 259
 Melone *f* 127
 Memorystick *m* 176
 Mensa *f* 168
 Menschen *m* 12, 16, 39
 Menstruation *f* 20
 Menübalen *m* 177
 Merkur *m* 280
 Mesosphäre *f* 286
 Messbecher *m* 69, 150, 311
 messen 310
 Messer *n* 65, 66
 Messerschärfer *m* 68, 118
 Messlöffel *m* 109
 Metall *n* 79
 Metallbohrer *m* 80
 Metalle *n* 289
 Metallsäge *f* 81
 metamorph 288
 Meteor *m* 280
 Meter *m* 310
 Metermaß *n* 80
 Metzger *m* 118, 188
 Metzgerei *f* 114
 Mexiko 314
 Mieder *n* 35
 Miesmuschel *f* 121
 Miete *f* 58
 mieten 58
 Mieter *m* 58
 Migräne *f* 44
 Mikrofon *n* 179, 258
 Mikrophongalgen *m* 179
 Mikroskop *n* 167
 Mikrowelle *f* 66
 Milch *f* 136, 156
 Milchprodukte *n* 107, 136
 Milchpulver *n* 137
 Milchreis *m* 130, 140
 Milchschokolade *f* 113
 Milchshake *m* 137
 Milchtüte *f* 136
 Milliarde 309
 Milligramm *n* 310
 Milliliter *m* 311
 Millimeter *m* 310
 Million 309
 Milz *f* 18
 Mineralien *n* 289
 Mineralwasser *n* 144
 Minibar *f* 101
 minirock *m* 34
 minus 165
 Minute *f*
 Minutenzeiger *m*
 Minze *f* 133
 mischen 273
 Mischpult *n* 179
 mit 320
 mit Automatik 200
 mit Formbügeln 35
 mit Handschaltung 200
 mit Kohlensäure 144
 mit Kopfdünger düngen 90
 mit offenem Oberdeck 260
 mit Rasen bedecken 90
 mit Schokolade überzogen 140
 mit Schokoladenstückchen 141
 mit Zahnseide reinigen 50
 Mittag *m* 305
 Mittagessen *n* 64
 Mittagsmenü *n* 152
 Mittelfeld *n* 228
 Mittelfinger *m* 15
 Mittelfußknochen *m* 17
 Mittelhandknochen *m* 17
 mittelharte Käse *m* 136
 Mittelkreis *m* 222, 224, 226
 Mittellinie *f* 226
 Mittelmeer *n* 313
 Mittelpunkt *m* 164
 Mittelstreifen *m* 194
 Mittelstürmer *m* 222
 Mittelwelle *f* 179
 Mitternacht *f* 305
 mittlere Spur *f* 194
 Mittwoch *m* 306
 Mixer *m* 66
 Mixerschüssel *f* 66
 Möbel *n* 105
 Möbelgeschäft *n* 115
 Mobile *n* 74
 Mode *f* 277
 Modedesigner *m* 277
 Modell *n* 169, 190
 Modellbau *m* 275
 Modellierholz *n* 275
 Moderator *m* 178
 Mohn *m* 138
 Moldawien 316
 Monaco 316
 Monat *m* 306
 monatlich 307
 Monatshygiene *f* 108
 Mond *m* 280
 Mondbohnen *f* 131
 Mondfähre *f* 281
 Mondsichel *f* 280
 Mondstein *m* 288
 Mongolei 318
 Monitor *m* 53
 Monopoly *n* 272
 Monsun *m* 287
 Montag *m* 306
 Montenegro 316
 Monument *n* 261
 Mopp *m* 77
 Morgen *m* 305
 morgen 306
 Morgendämmerung *f* 305
 Morgenmantel *m* 35
 Morgenrock *m* 31
 Mörser *m* 68, 167
 Mörtel *m* 187
 Mosambik 317
 Moschee *f* 300
 Moskitonetz *n* 267
 Motocross *n* 249
 Motor *m* 88, 202, 204
 Motorhaube *f* 198
 Motorrad *n* 204
 Motorradrennen *n* 249
 Motorradständer *m* 205
 Motte *f* 295
 Mountainbike *n* 206
 Mousse *f* 141
 Möwe *f* 292
 Mozzarella *m* 142
 Muffin *m* 140
 mulchen 91
 Müllimer *m* 67, 266
 Müllschaufel *f* 77
 Müllschlucker *m* 61
 multiplizieren 165
 Multivitaminmittel *n* 109
 Mumps *m* 44
 Mund *n* 14
 Mundschutz *m* 237
 Mundwasser *n* 72
 Mungbohnen *f* 131
 Münze *f* 97
 Münzfernsprecher *m* 99
 Münzrückgabe *f* 99
 Muschel *f* 265
 Museum *n* 261
 Musical *n* 255
 Musik *f* 162
 Musiker *m* 191
 Musikhochschule *f* 169
 Musikinstrumente *n* 256
 Musikstile *f* 259
 Muskatblüte *f* 132
 Muskatnuss *f* 132
 Muskeln *m* 16
 Mutter *f* 22, 80
 Muttermal *n* 14
 Mütze *f* 36
 Myanmar 318
N
 Naan *m* 139
 Nabe *f* 206
 Nabel *m* 12
 Nabelschnur *f* 52
 nach 320
 Nachbar *m* 24
 Nachmittag *m* 305
 Nachrichten *f* 100, 178
 Nachrichtensprecherin *f* 179
 nachschneiden 39
 Nachspeisen *f* 140
 nächste Woche 307
 Nacht *f* 305
 Nachthemd *n* 31, 35
 Nachttisch *m* 70, 153
 Nachttischlampe *f* 70
 Nachtwäsche *f* 31
 Nacken *m* 13
 Nadel *f* 109, 276
 Nadelbaum *m* 86
 Nadelkissen *n* 276
 Nagel *m* 80
 Nagelfeile *f* 41
 Nagelhaut *f* 15
 Nagelknipser *m* 41
 Nagelkopf *m* 81
 Nagellack *m* 41
 Nagellackentferner *m* 41
 Nagelschere *f* 41
 nahe 320
 nähren 277
 Näherin *f* 277
 Nähkorb *m* 276
 Nähmaschine *f* 276
 Nahrungsmittel *n* 118, 130
 Nahrungsmittel in Flaschen *n* 134
 Naht *f* 34, 52
 Namibia 317
 Nahrungsmittel *n* 109
 Nase *f* 14
 Nasenbluten *n* 44
 Nasenklemme *f* 238
 Nasenloch *n* 14
 Nasenriemen *m* 242
 Nashorn *n* 291
 nass 286, 321
 Nation *f* 315
 Nationalpark *m* 261
 Naturfaser *f* 31
 Naturheilkunde *f* 55
 Naturreis *m* 130
 Naturwissenschaft *f* 162
 Navi *n* 195
 navigieren 240
 Nebelfleck *m* 280
 neben 320
 Nebengebäude *n* 182
 Nebenwirkungen *f* 109
 Neffe *m* 23
 Negativ *n* 271
 negative Elektrode *f* 167
 Nektarine *f* 126
 Nelke *f* 110
 Nenner *m* 165

- Nennwert *m* 97
 Nepal 318
 Neptun *m* 280
 Nerv *m* 19, 50
 Nervensystem *n* 19
 nervös 25
 Nessel *f* 297
 Netz *n* 217, 226, 227, 231
 netzen 245
 Netzhaut *f* 51
 Netzwerk *n* 176
 neu 321
 Neubelag *m* 187
 neue Kartoffel *f* 124
 Neugeborene *n* 53
 Neujahr *n* 27
 Neumond *m* 280
 neun 308
 neunhundert 308
 neunter 309
 neunzehn 308
 neunzehnhundert 307
 neunzehnhunderteins 307
 neunzehnhundertzehn 307
 neunzehnter 309
 neunzig 308
 neunzigster 309
 Neurologie *f* 49
 Neuseeland 319
 neutral 60
 neutrale Zone *f* 224
 Nicaragua 314
 nicht falten 98
 Nichte *f* 23
 Nickel *m* 289
 Niederlande 316
 niedrig 321
 Niere *f* 18, 119
 Niesen *n* 44
 Niger 317
 Nigeria 317
 Nilpferd *n* 291
 Nockenriemen *m* 203
 Nord- und Mittelamerika 314
 Norden *m* 312
 Nordkorea 318
 nördliche Halbkugel *f* 283
 nördliche Polarkeis *m* 283
 Nordpol *m* 283
 Nordpolarmeer *n* 312
 Nordsee *f* 312
 normal 39
 Norwegen 316
 Notation *f* 256
 Notaufnahme *f* 48
 Notausgang *m* 210
 Note *f* 163, 256
 Noten *f* 255, 256
 Notfall *m* 46
 Nothebel *m* 209
 Notizblock *m* 173
 Notizbuch *n* 172
 Notizen *f* 191
 Notizen machen 163
 Notrufsäule *f* 195
 November *m* 306
 Nudelholz *n* 69
 Nudeln *f* 158
 Nugat *m* 113
 null 230, 308
 Nummernschild *n* 198
 Nüsse *f* 151
 Nüsse und das Dörrobst *f*, *n* 129
 Nylon *n* 277
O
 oben 98
 Oberarmknochen *m* 17
 obere Kuchenteil *m* 141
 Oberschenkel *m* 12
 Oberschenkelknochen *m* 17
 Oberschenkelmuskeln *m* 16
 Objektivlinse *f* 167
 Objektträger *m* 167
 Oboe *f* 257
 Obsidian *m* 288
 Obst *n* 107, 126, 128, 157
 Obstanbau *m* 183
 Obstkorb *m* 126
 Obstkuchenform *f* 69
 Obstsaft *m* 156
 Obsttortelette *n* 140
 Obus *m* 196
 offen 321
 offene Gedränge *n* 221
 ohne 320
 ohne Bedienung 152
 ohne Kohlensäure 144
 Ohr *n* 14
 Öhr *n* 244
 Ohrring *m* 36
 Okra *f* 122
 Oktober *m* 306
 Okular *m* 167
 Okularmuschel *f* 269
 Öl *n* 142, 199
 Öle *n* 134
 Ölfarben *f* 274
 Oliven *f* 151
 Olivenöl *n* 134
 Ölmesstab *m* 202
 Ölsumpf *m* 204
 Öltanker *m* 215
 Oman 318
 Omelett *n* 158
 Onkel *m* 22
 Onkologie *f* 49
 online 177
 Onyx *m* 289
 Opal *m* 288
 Oper *f* 255
 Operation *f* 48
 Operationssaal *m* 48
 Ophthalmologie *f* 49
 Optiker *m* 189
 orange 274
 Orange *f* 126
 Orangeade *f* 144
 Orangenmarmelade *f* 134, 156
 Orangensaft *m* 148
 Orchester *n* 254, 256
 Orchestergraben *m* 254
 Orchidee *f* 111
 Ordner *m* 172, 177
 Oregano *m* 133
 Origami *n* 275
 Orthopädie *f* 49
 Öse *f* 37, 276
 Osten *m* 312
 Osteopathie *f* 54
 Osterglocke *f* 111
 Ostern *n* 27
 Österreich 316
 Ostsee *f* 313
 Ost-Timor 319
 Otter *m* 290
 Ouvertüre *f* 256
 Oval *n* 164
 Overall *m* 82
 Ozean *m* 282
 Ozeandampfer *m* 215
 Ozonschicht *f* 286
P
 Paar *n* 24
 Päckchen *n* 311
 Päckchen Zigaretten *n* 112
 Packung *f* 311
 Paddel *n* 241
 Pädiairie *f* 49
 Paket *n* 99
 Pakistan 318
 Palette *f* 186, 274
 Palme *f* 86, 296
 Palmherzen *n* 122
 Panama 314
 Pandabär *m* 291
 Paniermehl *n* 139
 Panzer *m* 293
 Papagei *m* 293
 Papaya *f* 128
 Papierbehälter *m* 172
 Papierklammer *f* 173
 Papierkorb *m* 172, 177
 Papiermaché *n* 275
 Papierserviette *f* 154
 Papiertaschentuch *n* 108
 Papiertaschentuchschachtel *f* 70
 Pappe *f* 275
 Pappel *f* 296
 Paprika *f* 124
 Paprika *m* 132
 Papua-Neuguinea 319
 Par *n* 233
 Paraguay 315
 parallel 165
 Parallelogramm *n* 164
 Paranus *f* 129
 Parfum *n* 41
 Parfümerie *f* 105
 Park *m* 261, 262
 parken 195
 Parkett *n* 254
 Parkplatz *m* 298
 Parkuhr *f* 195
 Parmesan *m* 142
 Partner *m* 23
 Partnerin *f* 23
 Parfümerie *f* 105
 Pass *m* 213, 226
 Passagier *m* 216
 Passagierhafen *m* 216
 Passah *n* 27
 Passcode *m* 99
 Passionsfrucht *f* 128
 Passkontrolle *f* 212, 213
 Pastellstifte *m* 274
 Pastete *f* 142, 156, 158
 Pasteten *f* 143
 Pastetenform *f* 69
 pasteurisiert 137
 Pastinake *f* 125
 Patchwork *n* 277
 Pathologie *f* 49
 Patientenstuhl *m* 50
 Patiententabelle *f* 48
 Patientin *f* 45
 Patio *m* 85
 Pause *f* 254, 269
 Pausenzeichen *n* 256
 Pay-Kanal *m* 269
 Pazifische Ozean *m* 312
 Pecannuss *f* 129
 Pedal *n* 206
 Pediküre *f* 41
 Peeling *n* 41
 Pelikan *m* 292
 Pendler *m* 208
 Penguin *m* 292
 Penis *m* 21
 Peperoni *f* 124, 143
 Pepperoni *f* 142
 per Luftpost 98
 Pergola *f* 84
 Periduralanästhesie *f* 52
 Periodikum *n* 168
 Perlenkette *f* 36
 Persimone *f* 128
 Personal *n* 175
 Personalabteilung *f* 175
 Personenwaage *f* 45
 persönliche Bestleistung *f* 234
 Peru 315
 Perücke *f* 39
 Pessar *n* 21
 Pestizid *n* 89, 183
 Petersilie *f* 133
 Petrischale *f* 166
 Pfannenwender *m* 68
 Pfannkuchen *m* 157
 Pfau *m* 293
 Pfeffer *m* 64, 152
 Pfefferkorn *n* 132
 Pfefferminz *n* 113
 Pfefferminztee *m* 149
 Pfeife *f* 112
 Pfeil *m* 249
 Pferch *m* 185
 Pferd *n* 185, 235, 242
 Pferderennen *n* 243
 Pferdeschwanz *m* 39
 Pferdestall *m* 243
 Pfingstrose *f* 111
 Pfirsich *m* 126, 128
 pflanzen 183
 Pflanzen *f* 296
 Pflanzenarten *f* 86
 Pflanzenöl *n* 135
 Pflanzenschildchen *n* 89
 Pflanzschaufel *f* 89
 Pflaster *n* 47
 Pflaume *f* 126
 pflücken 91
 pflügen 183
 ppropfen 91
 Pfund *n* 310
 Phantombild *n* 181
 Philippinen 319
 Philosophie *f* 169
 Physik *f* 162, 169
 Physiotherapie *f* 49
 Picknick *n* 263
 Picknickbank *f* 266
 Picknickkorb *m* 263
 Pier *m* 217
 Pik *n* 273
 pikante Wurst *f* 142
 Pikkoloflöte *f* 257
 Pilates *f* 251
 Pille *f* 21, 109
 Pilot *m* 190, 211
 Pilz *m* 125
 Piment *m* 132
 Piniennuss *f* 129
 PIN-Kode *m* 96
 Pinne *f* 240
 Pinnwand *f* 173
 Pinsel *m* 274
 Pint *n* 311
 Pintobohnen *f* 131
 Pizette *f* 40, 47, 167
 Pipette *f* 167
 Pistazie *f* 129
 Pistole *f* 94
 Pitabrot *n* 139
 Pizza *f* 154
 Pizzabelag *m* 155
 Pizzeria *f* 154
 Plädoyer *n* 180
 Plakat *n* 255
 Plakattafel *f* 274
 Planet *m* 280, 282
 Planken *f* 85
 Planschbecken *n* 263
 Plastiktüte *f* 122
 plastische Chirurgie *f* 49
 Plateau *n* 284
 Platin *n* 289
 Platte *f* 283
 Platten *f* 85
 Plattengeschäft *n* 115
 Plattenspieler *m* 268
 Platz *m* 299
 Platzanweiser *m* 255
 Platzverweis *m* 223
 Plazenta *f* 52

- plus 165
 Pluto *m* 280
 pochieren 67
 pochiert 159
 Podium *n* 256
 Poker *n* 273
 Pol *m* 60, 282
 Polarlicht *n* 286
 Polaroidkamera *f* 270
 Polen 316
 polieren 77
 Politologie *f* 169
 Politur *f* 77
 Polizei *f* 94
 Polizeiauto *n* 94
 Polizeiwache *f* 94
 Polizeizelle *f* 94
 Polizist *m* 94, 189
 Poller *m* 214, 298
 Polo *n* 243
 Polster *n* 220, 224, 225
 Polyester *n* 277
 Pommes frites 154
 Poolbillard *n* 249
 Pop *m* 259
 Popcorn *n* 255
 Pore *f* 15
 Porridge *m* 157
 Port *m* 176
 Portfeuille *n* 97
 Portemonnaie *n* 37
 Portion *f* 64
 Portionierer *m* 68
 Portugal 316
 Portwein *m* 145
 Porzellan *n* 105
 Posaune *f* 257
 Pose *f* 244
 positive Elektrode *f* 167
 Post 98
 Postanweisung *f* 98
 Postbeamte *m* 98
 Postgebühr *f* 98
 postgraduierte 169
 Postkarte *f* 112
 Postleitzahl *f* 98
 Postsack *m* 98
 Poststempel *m* 98
 Posttasche *f* 190
 Praline *f* 113
 Präsentation *f* 174
 Preis *m* 152
 Preiselbeere *f* 127
 Preisliste *f* 154
 Prellung *f* 46
 Premiere *f* 254
 Presse *f* 178
 Pressluftbohrer *m* 187
 Privatbadezimmer *n* 100
 private Fitnesstrainerin *f* 250
 Privatjet *m* 211
 Privatunterhaltung *f* 268
 Privatzimmer *n* 48
 Probleme *n* 271
 Profilsäge *f* 81
 Programm *n* 176, 254, 269
 Programmgestaltung *f* 178
 Promenade *f* 265
 Promotion *f* 169
 Propeller *m* 211
 Prosciutto *f* 143
 Prospekt *m* 254
 Prostata *f* 21
 Protokoll *n* 174
 Protokollführer *m* 180
 Provinz *f* 315
 Provision *f* 97
 Prozentsatz *m* 165
 Prozessor *m* 176
 Prüfung *f* 163
 Psychiatrie *f* 49
 Psychotherapie *f* 55
 Publikum *n* 254
 Puck *m* 224
 Puder *m* 109
 Puderdose *f* 40
 Puderpinsel *m* 40
 Puderquaste *f* 40
 Puderrouge *n* 40
 Puerto Rico 314
 Pullover *m* 33
 Puls *m* 47
 Pult *n* 162, 269
 Pulver *n* 77
 Pumps *m* 37
 Punkmusik *f* 259
 pünktlich
 Pupille *f* 51
 Puppe *f* 75
 Puppenhaus *n* 75
 püriert 159
 Pute *f* 119
 Putter *m* 233
 putzen 77
 Puzzle *n* 273
 Pyramide *f* 164
Q
 Quadrat *n* 164
 Quadratfuß *m* 310
 Quadratmeter *m* 310
 Quelle *f* 295
 Quappe *f* 120
 Quart *n* 311
 Quarz *m* 289
 Quecksilber *n* 289
 quer 271
 Querflöte *f* 257
 Querlatte *f* 222
 Querruder *n* 210
 Quiche *f* 142
 Quitte *f* 128
 Quittung *f* 152
R
 Rachen *m* 19
 Rack *n* 268
 Racquetball *n* 231
 Rad *n* 198, 207
 Rad fahren 207
 Radar *m* 214, 281
 Radfahren *n* 263
 Radicchio *m* 123
 Radiergummi *m* 163
 Radieschen *n* 124
 Radio *n* 179, 268
 Radiologie *f* 49
 Radiowecker *m* 70
 Radius *m* 164
 Radkappe *f* 202
 Radmuttern *f* 203
 Radschlüssel *m* 203
 Rafting *n* 241
 Rahmen *m* 206, 230
 Rahmkäse *m* 136
 Rakete *f* 211
 Rallyefahren *n* 249
 RAM *n* 176
 Ramadan *m* 26
 Rap *m* 259
 Raps *m* 184
 Rapsöl *n* 135
 Rasen *m* 85, 90
 Rasenmäher *m* 88, 90
 Rasenrandschere *f* 88
 Rasensprenger *m* 89
 Rasieren *n* 73
 Rasierklinge *f* 73
 Rasierschaum *m* 73
 Rasierwasser *n* 73
 Rassel *f* 74
 Rathaus *n* 299
 Ratte *f* 290
 Rauch *m* 95
 Rauchen *n* 112
 Räucherfisch *m* 143
 Räucherheringe *m* 157
 Rauchmelder *m* 95
 Raumanzug *m* 281
 Raumfähre *f* 281
 Raumforschung *f* 281
 Raumstation *f* 281
 Raupe *f* 295
 Raureif *m* 287
 Reagenzglas *n* 166
 Rebound *m* 227
 Rechen *m* 88
 Rechnung *f* 152
 Recht *n* 180
 rechte Feld *n* 229
 rechte Spur *f* 194
 Rechteck *n* 164
 rechte Spur *f* 194
 rechts 260
 Rechtsabteilung *f* 175
 Rechtsanwalt *m* 180, 190
 Rechtsberatung *f* 180
 Rechtsfall *m* 180
 Rechtssteuerung *f* 201
 Rechtswissenschaft *f* 169
 Reck *n* 235
 Recyclingbehälter *m* 61
 Redakteurin *f* 191
 Reflexzonenmassage *f* 54
 Reformhaus *n* 115
 Regen *m* 287
 Regenbogen *m* 287
 Regenbogenföhle *f* 120
 Regenhaut *f* 245, 267
 Regenmantel *m* 31, 32
 Regenschirm *m* 36
 Regenwald *m* 285
 Reggae *m* 259
 Regio *f* 315
 Regisseur *m* 254
 Reibahle *f* 80
 Reibe *f* 68
 reiben 67
 reif 129
 Reifen *m* 198, 205, 206
 Reifendruck *m* 203
 Reifenpanne *f* 203, 207
 Reifenprofil *n* 207
 Reifenschlüssel *m* 207
 Reihe *f* 210, 254
 Reihen(haus) 58
 Reiki *n* 55
 Reiniger *m* 41
 Reinigung *f* 115
 Reinigungsartikel *m* 77
 Reinigungsmittel *n* 51, 77
 Reinigungstuch *n* 108
 Reis *m* 130, 158, 184
 Reisebüro *n* 114
 Reisebürokauffrau *f* 190
 Reisebus *m* 196
 Reiseumfänger *m* 260
 Reisekrankheitstabletten *f* 109
 Reisescheck *m* 97
 Reisetasche *f* 37
 Reisezweck *n* 213
 Reismelde *f* 130
 Reißnagel *m* 173
 Reißverschluss *m* 277
 Reiten *n* 263
 Reiter *m* 242
 Reitgerte *f* 242
 Reithelm *m* 242
 Reithose *f* 242
 Reitsport *m* 242
 Reitstiefel *m* 242
 Reitweg *m* 263
 Rekord *m* 234
 Reliefpapier *n* 83
 Renaissance- 301
 Rennbahn *f* 234, 243
 Rennboot *n* 214
 Rennbügel *m* 207
 Rennen *n* 234
 rennen 228
 Rennfahrer *m* 249
 Rennmaschine *f* 205
 Rennpferd *n* 243
 Rennrad *n* 206
 Rennrodeln *n* 247
 Rennsport *m* 249
 Reparaturkasten *m* 207
 Reporterin *f* 179
 Reproduktion *f* 20
 Reptilien *n* 293
 Restaurant *n* 101, 152
 Rettungsboot *n* 214, 240
 Rettungsring *m* 240
 Rettungssanitäter *m* 94
 Rettungsschwimmer *m* 265
 Rettungsturm *m* 265
 Return *m* 231
 Revers *n* 32
 Rezept *n* 45
 R-Gespräch *n* 99
 Rhabarber *m* 127
 Rhombus *m* 164
 rhythmische Gymnastik *f* 235
 Richter *m* 180
 Richtungsangaben *f* 260
 Riemen *m* 207
 Riesenslalom *m* 247
 Rinde *f* 136, 142, 296
 Rindfleisch *n* 118
 Ring *m* 36
 Ringbefestigungen *f* 89
 Ringe *m* 235
 Ringen *n* 236
 Ringfinger *m* 15
 Rinnstein *m* 299
 Rippe *f* 17, 126
 Rippen *f* 155
 Rippenstück *n* 119
 Robbe *f* 290
 Robe *f* 169
 Rochen *m* 120, 294
 Rochenflügel *m* 120
 Rock *m* 30, 34
 Rockbund *m* 35
 Rockkonzert *n* 258
 Rocky Moutains 312
 Rodeo *n* 243
 Roggenbrot *n* 138
 Roggenmehl *n* 138
 roh 124, 129
 Rohr *n* 202
 Rohrabschneider *m* 81
 Rohrzange *f* 81
 Rokoko- 301
 Rolle *f* 244, 245, 311
 Rolle Toilettenpapier *f* 72
 Rollenheft *n* 254
 Roller *m* 83, 205
 Rollo *n* 63
 Rollstuhl *m* 48
 Rollstuhlzugang *m* 197
 Rolltreppe *f* 104
 Röntgenaufnahme *f* 48, 50
 Röntgenbild *n* 50
 Röntgenbildbetrachter *m* 45
 rosa 274
 Röschen *n* 122
 Rose *f* 110
 rosé 145
 Rosenkohl *m* 122
 Rosenschere *f* 89
 Rosine *f* 129
 Rosinenbrot *n* 139
 Rosmarin *m* 133
 Rost *m* 67
 rostfreie Stahl *m* 79

- rot 39, 145, 274
rotbraun 39
Rote Bete *f* 125
rote Fleisch *n* 118
rote Karte *f* 223
Rote Meer *n* 313
rote Meeräsche *f* 120
roten Bohnen *f* 131
roten Linsen *f* 131
Rotfärbung der Augen
f 271
Rotorblatt *n* 211
Rotzunge *f* 120
Rough *n* 232
Route *f* 260
Ruanda 317
Rübe *f* 124
Rubin *m* 288
Rücken *m* 13
Rückenbürste *f* 73
Rückenflosse *f* 294
rückenfrei 35
Rückenlehne *f* 210
Rückenmuskel *m* 16
Rückenschwimmen *n*
239
Rückgabedatum *n*
168
Rückhand *f* 231
Rücklauf *m* 269
Rücklicht *n* 207
Rucksack *m* 31, 37,
267
Rücksitz *m* 200
Rückspiegel *m* 198
Rückstrahler *m* 207
rückwärts fahren 195
Ruder *n* 241
Ruderboot *n* 214
Ruderer *m* 241
Rudermaschine *f* 250
rudern 241
Rufknopf *m* 48
Rugby *n* 221
Rugbyball *m* 221
Rugbyspieler *m* 221
Rugbytrikot *n* 221
Rührei *n* 157
rühren 67
Rührschüssel *f* 69
Rukula *m* 123
Rum *m* 145
Rum mit Cola *m* 151
Rumänien 316
Rumpf *m* 210, 214, 240
Rumpfeben *n* 251
Rumpsteak *n* 119
Runde *f* 237
runde Ausschnitt *m* 33
Rundfunkstation *f* 179
Rundkorn- 130
Rüssel *m* 291
Russische Föderation 318
Rutsche *f* 263
rutschen 229
- S
säen 90, 183
- Safaripark *m* 262
Safran *m* 132
Saft *m* 109, 127
Säfte und Milchshakes *m*
149
saftig 127
sägen 79
Sahara *f* 313
Sahne *f* 137, 140, 157
Sahnetorte *f* 141
Saint Kitts und Nevis 314
Saint Lucia 314
Saint Vinzent und die
Grenadinen 314
Route 129
Saite *f* 230, 258
Saiteninstrumente *n* 256
Salamander *m* 294
Salami *f* 142
Salat *m* 123, 149
Salatsoße *f* 158
Salbe *f* 47, 109
Salbei *m* 133
Salomonen 319
Salto *m* 235
Salz *n* 64, 152
salzig 155
Sambia 317
Samen *m* 88, 122, 130
Samenausführungsgang
m 21
Samenbläschen *n* 21
Samenleiter *m* 21
Sämling *m* 91
Samstag *m* 306
San Marino 316
Sand *m* 85, 264
Sandale *f* 37
Sandalen *f* 31
Sandburg *f* 265
Sandkasten *m* 263
Sandsack *m* 237
Sandstein *m* 288
Sandwich *m* 155
Sandwichtheke *f* 143
Sängerin *f* 191
Sao Tomé und Príncipe
317
Saphir 288
Sardine *f* 120
Sardiniern 316
Satellit *m* 281
Satellitenschüssel *f* 269
Satsuma *f* 126
satt 64
Sattel *m* 206, 242
Satteltgurt *m* 242
Sattelstütze *f* 206
Saturn *m* 280
Satz *m* 230
saubere Wäsche *f* 76
Saubohnen *f* 131
Saudi-Arabien 318
sauer 127
Sauerteigbrot *n* 139
Sauger *m* 75, 81
Säugetiere *n* 290
Saugglocke *f* 53
- Säuglingspflege *f* 74
Saugschlauch *m* 77
Säule *f* 300
Saum *m* 34
Sauna *f* 250
saure Sahne *f* 137
Saxophon *n* 257
Scan *m* 48
Scanner *m* 106, 176
Schablone *f* 83
Schach *n* 272
Schachbrett *n* 272
Schachtel Pralinen *f* 113
Schädel *m* 17
Schaf *n* 185
Schaffarm *f* 183
Schaffner *m* 209
Schafsmilch *f* 137
Schal *m* 31
Schale *f* 126, 127, 128,
129
schälen 67
Schäler *m* 68
Schalldämpfer *m* 204
Schalotte *f* 125
schalten 207
Schalter *m* 60, 96, 98,
100
Schalthebel *m* 201, 207
Schamlippen *f* 20
scharf 124
Schaschlik *m* 158
Schattenspflanze *f* 87
Schauer *m* 286
Schaufel *f* 187
Schaufel *f* 263
Schaum *m* 148
Schaumbad *n* 73
Schaumöffel *m* 68
Schauspieler *m* 179,
254
Schauspielerin *f* 191,
254
Scheck *m* 96
Scheckheft *n* 96
Scheibe *f* 119, 139
Scheibenbrot *n* 138
Scheibenputzmittel-
behälter *m* 202
Scheibenschießen *n* 249
Scheibenwaschanlage *f*
199
Scheibenwischer *m* 198
Scheide *f* 20
Scheidenmuschel *f* 121
Scheidung *f* 26
Schein *m* 97
Scheinwerfer *m* 198,
205, 259
Schellfisch *m* 120
Schenkel *m* 119
Schere *f* 38, 47, 276
Scheune *f* 182
Schiebedach *n* 202
Schiedsrichter *m* 222,
225, 226, 229, 230
Schiedsrichterball *m* 226
Schiefer *m* 288
- Schienbein *n* 12, 17
Schiene *f* 47, 208
schießen 223, 227
Schiff *n* 214
Schiffsschraube *f* 214
Schilddrüse *f* 18
Schildkröte *f* 293
Schinken *m* 119, 143,
156
Schirm *m* 233
Schirmständer *m* 59
Schlafabteil *n* 209
Schlafanzug *m* 30, 33
Schläfe *f* 14
Schlafen *n* 74
Schlaflosigkeit *f* 71
Schlafmatte *f* 267
Schlafmittel *n* 109
Schlafsack *m* 267
Schlafzimmer *n* 70
Schlag *m* 233
Schlaganfall *m* 44
Schläge *m* 231
schlagen 67, 224, 225,
229
Schläger *m* 224
Schlägerspiele *n* 231
Schlagfehler *m* 228
Schlagholz *n* 225
Schlaginstrumente *n* 257
Schlagmal *n* 228
Schlagmann *m* 225, 228
Schlagsahne *f* 137
Schlagzeug *n* 258
Schlagzeuger *m* 258
Schlange *f* 293
Schlauch *m* 95, 207
Schlauchboot *n* 215
Schlauchwagen *m* 89
schlecht 321
Schlegel *m* 275
Schleier *m* 35
Schleierkraut *n* 110
Schleifmaschine *f* 78
Schleppdampfer *m* 215
Schleppe *f* 35
schleudern 76
Schleudertrauma *n* 46
Schlick *m* 85
Schließfächer *n* 239
Schlinge *f* 46
Schlittensfahren *n* 247
Schlittschuh laufen 224
Schloss *n* 59
Schlot *m* 283
Schlucht *f* 284
Schlüssel *m* 59, 80, 207
Schlüsselbein *n* 17
Schlüsselblume *f* 297
schmal 321
Schmerzmittel *n* 109
Schmerztabletten *f* 47
Schmetterball *m* 231
Schmetterling *m* 295
schmiegeln 82
Schmirgelpapier *n*
81, 83
Schmortopf *m* 69
- Schmuck *m* 36
Schmuckkasten *m* 36
Schmucksteine *m* 288
schmutzige Wäsche *f* 76
Schnabel *m* 293
schnarchen 71
Schnauze *f* 293
Schnecke *f* 295
Schnee *m* 287
Schneeanzug *m* 30
Schneebesen *m* 68
Schneemobil *n* 247
Schneeregen *m* 286
schneiden 38, 67, 79,
277
Schneider *m* 80, 88, 191
Schneiderei *f* 115
Schneiderkreide *f* 276
Schneidersack *m* 276
Schneidezahn *m* 50
schnell 321
schnell zubereitet 130
Schnellbootsport *n* 241
Schnellbratgericht *n* 158
Schnellimbiss *m* 154
Schnellstraße *f* 195
Schnitt *m* 46
Schnitte *f* 121
Schnittlauch *m* 133
Schnittmuster *n* 276
schnitzen 79
Schnorchel *m* 239
Schnur *f* 244
schnurlose Telefon *n* 99
Schnurrhaare *n* 290
Schnürschuh *m* 37
Schnürsenkel *m* 37
Schock *m* 47
schockiert 25
Schokolade *f* 156
Schokoladenaufstrich *m*
135
Schokoladenmilchshake
m 149
Schokoladentorte *f* 140
Schönheit *f* 40
Schönheitsbehandlungen
f 41
Schönheitspflege *f* 105
Schöpflöffel *m* 68
Schornstein *m* 58, 214
Schot *f* 241
Schote *f* 122
Schraube *f* 80
Schraubenschlüssel *m*
80
Schraubenzieher *m* 80
Schraubenziehereinsätze
m 80
Schraubstock *m* 78
schreiben 162
Schreibtisch *m* 172
Schreibwaren *f* 105
schreiben 25
Schreiner *m* 188
Schriftart *f* 177
Schritt *m* 143
schrubben 77

- Schubkarren *m* 88
 Schublade *f* 66, 70, 172
 schüchtern 25
 Schuh *m* 233
 Schuh mit hohem Absatz *m* 37
 Schuhabteilung *f* 104
 Schuhe *m* 34, 37
 Schuhgeschäft *n* 114
 Schulbuch *n* 163
 Schulbus *m* 196
 schuldig 181
 Schule *f* 162, 299
 Schüler *m* 162
 Schulanfänger *m* 162
 Schulleiter *m* 163
 Schulumädchen *n* 162
 Schultasche *f* 162
 Schulte *f* 13
 Schulterblatt *n* 17
 Schulterpolster *n* 35
 Schulterriemen *m* 37
 Schuppe *f* 121, 294
 Schuppen *f* 39, 293
 Schuppen *m* 84
 Schürze *f* 30, 69
 Schuss *m* 151
 Schüssel *f* 65
 Schutz *m* 88
 Schutzanstrich *m* 83
 Schutzblech *n* 205
 Schutzbrille *f* 81, 167
 Schutzhelm *m* 95, 186, 224
 Schutzkappe *f* 270
 Schutzmaske *f* 228
 schwach 321
 Schwager *m* 23
 Schwägerin *f* 23
 Schwalbe *f* 292
 Schwamm *m* 73, 74, 83
 Schwan *m* 293
 schwanger 52
 Schwangerschaft *f* 52
 Schwangerschaftstest *m* 52
 Schwanz *m* 121, 242, 290, 294
 Schwänzchen *n* 39
 Schwarte *f* 119
 schwarz 39, 272, 274
 schwarze Gürtel *m* 237
 schwarze Johannisbeere *f* 127
 schwarze Kaffee *m* 148
 schwarze Loch *n* 280
 Schwarze Meer *n* 313
 schwarze Olive *f* 143
 schwarze Tee *m* 149
 Schwebebalken *m* 235
 Schweden 316
 Schwefel *m* 289
 Schweif *m* 280
 Schweifsäge *f* 81
 Schwein *n* 185
 Schweinefarm *f* 183
 Schweinefleisch *n* 118
 Schweinestall *m* 185
 Schweißband *n* 230
 Schweiz *f* 316
 schwer 321
 Schwerkraft *f* 280
 Schwert *n* 241
 Schwertfisch *m* 120, 294
 Schwester *f* 22
 Schwiegermutter *f* 23
 Schwiegersohn *m* 22
 Schwiegertochter *f* 22
 Schwiegervater *m* 23
 Schwimmbad *n* 101
 Schwimmbecken *n* 238, 250
 Schwimmbrille *f* 238
 schwimmen 238
 Schwimmer *m* 61, 238
 Schwimmfloß *n* 238
 Schwimmflosse *f* 239
 Schwimmflügel *m* 238
 Schwimmreifen *m* 265
 Schwimmsport *m* 238
 Schwimmstile *m* 239
 Schwimmweste *f* 240
 schwimmen 232
 Science-Fiction-Film *m* 255
 Scotch mit Wasser *m* 151
 Scrabble *n* 272
 Scrollbalken *m* 177
 sechs 308
 Sechseck *n* 164
 sechshundert 308
 sechster 309
 sechzehn 308
 sechzehnter 309
 sechzig 308
 sechzigster 309
 sedimentär 288
 See *m* 285
 Seebarsch *m* 120
 Seebrassen *m* 120
 Seefischerei *f* 245
 Seelöwe *m* 290
 Seemann *m* 189
 Seepferd *n* 294
 Seepolyp *m* 121, 295
 Seestern *m* 295
 Seeszunge *f* 120
 Segel *n* 241
 Segelboot *n* 215
 Segelfliegen *n* 248
 Segelflugzeug *n* 211, 248
 Segeljacht *f* 240
 Segelsport *m* 240
 Sehenswürdigkeiten *f* 261
 Sehkräft *f* 51
 Sehne *f* 17
 Sehnenband *n* 17
 Sehnerv *m* 51
 Sehtest *m* 51
 Seide *f* 277
 Seife *f* 73
 Seifenoper *f* 178
 Seifenschale *f* 73
 Seil *n* 248
 Seilspringen *n* 251
 sein Testament machen 26
 Seite *f* 164
 Seitendeck *n* 240
 Seitenleitwerk *n* 210
 Seitenlinie *f* 220, 221, 226, 230
 Seitenpferd *n* 235
 Seitenruder *n* 210
 Seitenspiegel *m* 198
 Seitenstraße *f* 299
 Seitenstreifen *m* 194
 Seitfußstoß *m* 237
 Sekretariat *n* 168
 Sekunde *f* 304
 Sekundenzeiger *m*
 Selbstbräunungscreme *f* 41
 selbstsicher 25
 Selbstverteidigung *f* 237
 Sellerie *m* 124
 senden 177, 178
 Sendung *f* 179
 Senegal 317
 Senf *m* 155
 Senfkorn *n* 131
 Senkblei *n* 82
 senkrecht 165
 Sepie *f* 121
 September *m* 306
 Serbien 316
 Server *m* 176
 Serviceprovider *m* 177
 servieren 64
 Servierlöffel *m* 68
 Serviette *f* 65
 Serviettenring *m* 65
 Sesamkorn *n* 131
 Sesamol *n* 134
 Sessel *m* 63
 Sessellift *m* 246
 Set *n* 64, 179
 Setzkasten *m* 89
 Setzkescher *m* 244
 seufzen 25
 Shampoo *n* 38
 Sherry *m* 145
 Shiatsu *n* 54
 Shorts 30, 33
 Sibirien 313
 sich aufwärmen 251
 sich befreunden 26
 sich übergeben 44
 sich verlieben 26
 Sicherheit *f* 75, 240
 Sicherheitsbohrer *m* 80
 Sicherheitsgurt *m* 198, 211
 Sicherheitsnadel *f* 47
 Sicherheitssperre *f* 246
 Sicherheitsventil *n* 61
 Sicherheitsvorkehrungen *f* 212
 sichern 177
 Sicherung *f* 60
 Sicherungskasten *m* 60, 203
 Sieb *n* 68, 89
 sieben 91, 138, 308
 siebenhundert 308
 siebter 309
 siebzehn 308
 siebzehnter 309
 siebzig 308
 siebzigster 309
 Siegerpodium *n* 235
 Sierra Leone 317
 Signal *n* 209
 Silber *n* 235, 289
 Silo *m* 183
 Simbabwe 317
 Singapur 319
 Sinus *m* 19
 Sirene *f* 94
 Sitz *m* 204, 209, 210, 242
 Sitzfläche *f* 64
 Sitzung *f* 174
 Sitzungsraum *m* 174
 Sizilien 316
 Skalpell *n* 81, 167
 Skateboard *n* 249
 Skateboardfahren *n* 249, 263
 Skelett *n* 17
 Ski *m* 246
 Skibrille *f* 247
 Skihang *m* 246
 Skijacke *f* 246
 Skiläuferin *f* 246
 Skipiste *f* 246
 Skisport *m* 246
 Skisprung *m* 247
 Skistiefel *m* 246
 Skistock *m* 246
 Skizze *f* 275
 Skizzenblock *m* 275
 Skorpion *m* 295
 Slalom *m* 247
 Slice *m* 230
 Slip *m* 33, 35
 Slippeinlage *f* 108
 Slipper *m* 37
 Slowakei 316
 Slowenien 316
 Smaragd *m* 288
 Smartphone *n* 176
 SMS *f* 99
 Snackbar *f* 148
 Snooker *n* 249
 Snowboarding *n* 247
 Socken *f* 33
 Sodabrot *n* 139
 Sodawasser *n* 144
 Sofa *n* 62
 Sofakissen *n* 62
 Sofortbildkamera *f* 270
 Software *f* 176
 Sohle *f* 37
 Sohn *m* 22
 Sojabohnen *f* 131
 Sojasprosse *f* 122
 Soldat *m* 189
 Somalia 317
 Sommer *m* 31, 307
 Sommersprosse *f* 15
 Sonate *f* 256
 Sonde *f* 50
 Sonne *f* 280
 Sonnenaufgang *m* 305
 sonnenbaden 264
 Sonnenbank *f* 41
 Sonnenblock *m* 108, 265
 Sonnenblume *f* 184, 297
 Sonnenblumenkern *m* 131
 Sonnenblumenöl *n* 134
 Sonnenbrand *m* 46
 Sonnenbräune *f* 41
 Sonnenbrille *f* 51, 265
 Sonnenhut *m* 30, 265
 Sonnenmilch *f* 265
 Sonnenschein *m* 286
 Sonnenschirm *m* 264
 Sonnenschutzcreme *f* 108
 Sonnensystem *n* 280
 Sonnenuhr *f* 262
 Sonnenuntergang *m* 305
 sonnig 286
 Sonntag *m* 306
 Sorbett *n* 141
 Soße *f* 134, 143, 155
 Soufflé *n* 158
 Souffléform *f* 69
 Sozialsitz *m* 204
 Spachtel *m* 68, 82
 Spachtelmasse *f* 83
 spachteln 82
 Spalier *n* 84
 Spanholz *n* 79
 Spanien 316
 Spannen *m* 15
 Spannung *f* 60
 Spareinlagen *f* 96
 Spargel *m* 124
 Sparkonto *n* 97
 Sparran *n* 237
 spät 305
 Spatel *m* 167
 Spaten *m* 88, 265
 später 304
 Spatz *m* 292
 Specht *m* 292
 Speck *m* 118
 Speckscheibe *f* 119
 Speerfischen *n* 245
 Speerwerfen *n* 234
 Speibecken *n* 50
 Speiche *f* 17, 207
 Speicher *m* 176
 Speisekarte *f* 148, 153, 154
 Speiseröhre *f* 19
 Speisewagen *m* 209
 Spermium *n* 20
 Sperrholz *n* 79
 Spezialitäten *f* 152
 Spiegel *m* 40, 71, 167
 Spiegelei *n* 157
 Spiel *n* 230, 273

- Spielanzug *m* 30
 Spielbahn *f* 225, 233
 Spiele *n* 272
 spielen 229, 273
 Spielen *n* 75
 Spieler *m* 273
 Spielerbank *f* 229
 Spielergebnis *n* 273
 Spielnummer *f* 226
 Spielfeld *n* 220, 221, 226, 228
 Spielfeldgrenze *f* 225
 Spielfilm *m* 269
 Spielhaus *n* 75
 Spielmarke *f* 272
 Spielplatz *m* 263
 Spielshow *f* 178
 Spielstand *m* 220
 Spielwaren *f* 105
 Spielzeug *n* 75
 Spielzeugkorb *m* 75
 Spieß *m* 68
 Spikes *m* 233
 Spin *m* 230
 Spinat *m* 123
 Spinne *f* 295
 Spinnerkasten *m* 244
 Spion *m* 59
 Spirale *f* 21
 Spitze *f* 35, 37, 122, 165, 246
 Spitzenklöppelei *f* 277
 Spitzer *m* 163
 Spitzhacke *f* 187
 Splitter *m* 46
 Sport *m* 162, 220, 236
 Sportangeln *n* 245
 Sportartikel *m* 105
 Sportjackett *n* 33
 Sportkabriclett *n* 198
 Sportler *m* 191
 Sportplatz *m* 168
 Sportschuh *m* 37
 Sportschuhe *m* 31
 Sportwagen *m* 75
 Sprachen *f* 162
 Sprachmitteilung *f* 99
 Spray *m* 109
 Sprechanlage *f* 59
 Sprecherin *f* 174
 Sprechzimmer *n* 45
 Springbrunnen *m* 85
 springen *m* 227
 springen lassen 227
 Springer *m* 238, 272
 Springreiten *n* 243
 Sprinter *m* 234
 Spritzbeutel *m* 69
 Spritze 48, 109, 167, 311
 Spritzschutz *m* 66
 Sprühdose *f* 311
 sprühen 91
 Sprung *m* 235, 237, 239, 243
 Sprungbrett *n* 235, 238
 Sprungfeder *f* 71
 Spülbecken *n* 66
 Spule *f* 276
 Spüle *f* 61
 spülen 76, 77
 Spüler *m* 276
 Spülkasten *m* 61
 Spülmaschine *f* 66
 Squash *n* 231
 Sri Lanka 318
 Staat *m* 315
 Staatsanwaltschaft *f* 180
 Stab *m* 225, 235
 Stabhochsprung *m* 234
 Stachel *m* 295
 Stachelbeere *f* 127
 Stadien *n* 23
 Stadion *n* 223
 Stadt *f* 298, 299
 Stadtplan *m* 261
 Stadtrundfahrtbus *m* 260
 Staffelei *f* 274
 Staffellauf *m* 235
 Stahlwolle *f* 81
 Stake *f* 245
 Stall *m* 185
 Stallbursche *m* 243
 Stamm *m* 296
 Stammaktie *f* 97
 Ständer *m* 88, 268
 Stange *f* 90, 207, 250
 Stangen *f* 133
 Stangenbohne *f* 122
 Stangensellerie *m* 122
 stark 321
 Start- und Landebahn *f* 212
 Startblock *m* 234, 238
 starten 211
 Startlinie *f* 234
 Startsprung *m* 239
 Stativ *n* 166, 270, 281
 Staub wischen 77
 Staubgefäß *n* 297
 Staubsauger *m* 77, 188
 Staubtuch *n* 77
 Staudamm *m* 300
 Staudenrabatte *f* 85
 stechen 90
 Stechmücke *f* 295
 Stechpalme *f* 296
 Steckdose *f* 60
 Stecker *m* 60
 Stecknadel *f* 276
 Steckschlüssel *m* 80
 Steg *m* 258
 Steigbügel *m* 242
 Stein *m* 272, 275
 Steingarten *m* 84
 Steinobst *n* 126
 Steiß- 52
 Steißbein *n* 17
 Stempel *m* 173
 Stempelkissen *n* 173
 Stengel *m* 111, 297
 Steppdecke *f* 71
 sterben 26
 stereo 269
 steril 20, 47
 Stern *m* 280
 Sternarnis *m* 133
 Sternbild *n* 281
 Sternfrucht *f* 128
 Sternhyazinthen *f* 297
 Stethoskop *n* 45
 Steuer *f* 96
 Steuerhebel *m* 269
 Steuerrakete *f* 281
 Steuerung *f* 204
 Stich *m* 46, 277
 Stichplatte *f* 276
 Stabhochsprung *m* 234
 Stichwähler *m* 276
 Stickerei *f* 277
 Stickrahmen *m* 277
 Stiefel *m* 37, 220
 Stiefmutter *f* 23
 Stiefsohn *m* 23
 Stieftochter *f* 23
 Stiefvater *m* 23
 Stiel *m* 112, 187, 297
 Stier *m* 185
 Stillbüstenhalter *m* 53
 stillen 53
 Stillen *n* 53
 Stimmbänder *n* 19
 Stipendium *n* 169
 Stirn *f* 14
 Stirnmuskel *m* 16
 Stirnriemen *m* 242
 Stirnrunzeln *n* 25
 Stock *m* 58, 91
 Stoff *m* 276, 277
 Stoffdrücker *m* 276
 Stoffwindel *f* 30
 stolz 25
 Stop *m* 269
 stopfen 277
 Stoppball *m* 230
 Stoppuhr *f* 234
 Stöpsel *m* 72, 166
 Storch *m* 292
 Stoß *m* 237, 239
 Stöbel *m* 68
 Stoßstange *f* 198
 Stoßzahn *m* 291
 Stoßzeit *f* 209
 Stout *m* 145
 Strafmaß *n* 181
 Strafraum *m* 223
 Strafregister *n* 181
 Straftäter *m* 181
 Strähnen *f* 39
 Strampelanzug *m* 30
 Strand *m* 264
 Strandhäuschen *n* 264
 Strandsandale *f* 37
 Strandtasche *f* 264
 Strandtuch *n* 265
 Strang *m* 277
 Straße *f* 298
 Straßen *f* 194
 Straßenanzug *m* 32
 Straßenarbeiten *f* 187
 Straßenbahn *f* 196, 208
 Straßenbaustelle *f* 195
 Straßencafé *n* 148
 Straßenecke *f* 298
 Straßenlaterne *f* 298
 Straßenmarkierungen *f* 194
 Straßenrad *n* 206
 Straßenschild *n* 298
 Stratosphäre *f* 286
 Strauß *m* 111, 292
 Streaming *n* 269
 Strebebepfeiler *m* 301
 Strecken *n* 251
 Streichbürste *f* 83
 Stress *m* 55
 Strichkode *m* 106
 Stricken *n* 277
 Strickjacke *f* 32
 Stricknadel *f* 277
 Strohalm *m* 144, 154
 Strom *m* 60
 Stromanschluss *m* 266
 Stromausfall *m* 60
 stromführende Schiene *f* 209
 Stromkabel *n* 176
 Stromnetz *n* 60
 Stromschnellen *f* 284
 Stromzähler *m* 60
 Strumpf *m* 35
 Strumpfband *n* 35
 Strumpfhalter *m* 35
 Strumpfhose *f* 251
 Strunk *m* 122
 Stuck *m* 63
 Stück *n* 140, 311
 Student *m* 169
 Studentenheim *n* 168
 Studioeinrichtung *f* 178
 Stufenbarren *m* 235
 Stuhl *m* 64
 Stunde *f* 163
 Stundenzeiger *m*
 Sturm *m* 286
 Sturz *m* 186
 Stütze *f* 187
 stutzen 90
 Stützräder *m* 207
 subtrahieren 165
 suchen 177
 Südafrika 317
 Sudan 317
 Süden *m* 312
 Südfrüchte *f* 128
 Südkorea 318
 südliche Halbkugel *f* 283
 Südpolarmeer *n* 313
 Südsudan 317
 Sultanine *f* 129
 Sumo *n* 237
 Sumpf *m* 285
 Supermarkt *m* 106
 Suppe *f* 153, 158
 Suppenlöffel *m* 65
 Suppenteller *m* 65
 Surfbrett *n* 241
 Surfer *m* 241
 Suriname 315
 süß 124, 127, 155
 süße Aufstrich *m* 134
 Süßkartoffel *f* 125
 Süßwaren *f* 107, 113
 Süßwarengeschäft *n* 113
 Süßwasserangeln *n* 245
 Swasiland 337
 Sweatshirt *n* 303
 Symbol *n* 177
 Symphonie *f* 256
 Synagoge *f* 300
 Synchronschwimmen *n* 239
 synthetisch 31
 Syrien 318
 System *n* 176

T

- Tabak *m* 112, 184
 Tablett *n* 152, 154
 Tachometer *m* 201, 204
 Tadschikistan 318
 Taekwondo *n* 236
 Tafel *f* 162
 Tafel Schokolade *f* 113
 Tag *m* 306
 Tagesdecke *f* 70
 Tagesordnung *f* 174
 Tai Chi *n* 236
 Taille *f* 12
 Takelung *f* 215, 240
 Taktstock *m* 256
 Taktstrich *m* 256
 Tal *n* 284
 Tamarillo *f* 128
 Tamburin *n* 257
 Tampon *m* 108
 Tandem *n* 206
 Tangelo *f* 126
 Tankstelle *f* 199
 Tankstellenplatz *m* 199
 Tansania 317
 Tante *f* 22
 Tanzakademie *f* 169
 Tänzerin *f* 191
 Tanzmusik *f* 259
 Tapedeck *n* 268
 Tapete *f* 82, 177
 Tapetenkleister *m* 82
 Tapezierbürste *f* 82
 Tapezieren *n* 82
 tapezieren 82
 Tapezierer *m* 82
 Tapeziermesser *n* 82
 Tapezierschere *f* 82
 Tapeziertisch *m* 82
 Tapisserie *f* 277
 Tarowurzel *f* 124
 Tasche *f* 32
 Taschen *f* 37
 Taschenlampe *f* 267
 Taschenrechner *m* 165
 Taschentuch *n* 36
 Tasmanien 319
 Tastatur *f* 172, 176
 Taste *f* 176
 Tastenfeld *n* 97, 99
 Tätigkeiten *f* 77, 183
 Tätowierung *f* 41
 Taube *f* 292
 tauchen 238

- Tauchen *n* 239
 Taucheranzug *m* 239
 Tauchermaske *f* 239
 Taufe *f* 26
 Tausendfüßler *m* 295
 Taxifahrer *m* 190
 Taxistand *m* 213
 Team *n* 229
 Techniken *f* 237
 Teddy *m* 75
 Tee *m* 144, 149, 184
 Tee mit Milch *m* 149
 Tee mit Zitrone *m* 149
 Teebeutel *m* 144
 Teeblätter *n* 144
 Teekanne *f* 65
 Teelöffel *m* 65
 Teetasse *f* 65
 Teich *m* 85
 Teig *m* 138, 140
 Teilchen *n* 140
 Teiler *m* 173
 teilnehmen 174
 Teint *m* 41
 Telefon *n* 99
 Telefonzelle *f* 99
 Telegramm *n* 98
 Teleprompter *m* 179
 Teleskop *n* 281
 Teller *m* 65
 Tempel *m* 300
 Temperatur *f* 286
 Temperaturanzeige *f* 201
 Tennis *n* 230
 Tennisball *m* 230
 Tennisplatz *m* 230
 Tennisschläger *m* 230
 Tennisschuhe *m* 231
 Tennisspieler *m* 231
 Teppich *m* 63, 71
 Tequila *m* 145
 Termin *m* 45, 175
 Terminal *m* 212
 Terminkalender *m* 173, 175
 Terminplaner *m* 175
 Termiten *f* 295
 Terparbohnen *f* 131
 Terpentin *n* 83
 Terrassencafé *n* 148
 Territorium *n* 315
 Tesafilm *m* 173
 Tesafilmhalter *m* 173
 Text *m* 259
 Thailand 318
 Thanksgiving Day *m* 27
 Theater *n* 254, 299
 Theaterkostüm *n* 255
 Theaterstück *n* 254
 Theke *f* 142, 150
 Therapeutin *f* 55
 Thermometer *n* 45, 167
 Thermosflasche *f* 267
 Thermosphäre *f* 286
 Thermostat *m* 61
 Thermodaunenwäsche *f* 35
 Thermowäsche *f* 267
 Thriller *m* 255
 Thymian *m* 133
 Tiefe *f* 165
 tiefe Ende *n* 239
 tiefgefroren 121, 124
 Tiegel *m* 166
 Tierärztin *f* 189
 Tiere *n* 292, 294
 Tierfutter *n* 107
 Tierhandlung *f* 115
 Tiger *m* 291
 Tintenfisch *m* 121, 295
 Tisch *m* 64, 148, 167
 Tischdecke *f* 64
 Tischtennis *n* 231
 Tischtennisschläger *m* 231
 Titel *m* 168
 Toast *m* 157
 Toaster *m* 66
 Tochter *f* 22
 Toffee *n* 113
 Togo 317
 Toilette *f* 72
 Toiletten *f* 104, 266
 Toilettenartikel *m* 41, 107
 Toilettenbürste *f* 72
 Toilettsitz *m* 61, 72
 Tomate *f* 125, 157
 Tomatenketchup *m* 154
 Tomatensaft *m* 144, 149
 Ton *m* 275
 Tonabnehmer *m* 258
 Tonhöhe *f* 256
 Tonicwater *n* 144
 Tonleiter *f* 256
 Tonmeister *m* 179
 Tonne *f* 310
 Tonspur *f* 255
 Tonstudio *n* 179
 Topas *m* 288
 Töpfchen *n* 74
 Töpferei *f* 275
 Topfhandschuh *m* 69
 Topfpflanze *f* 87, 110
 Topinambur *m* 125
 Tor *n* 85, 182, 221, 223, 224, 247
 Torlinie *f* 220, 223, 224
 Tornado *m* 287
 Tornetz *n* 222
 Torpfosten *m* 220, 222
 Torraum *m* 221, 223
 Törtchenform *f* 69
 Torwächter *m* 225
 Torwart *m* 222, 224
 Touchdown *m* 220
 Tourenfahrrad *n* 206
 Tourer *m* 205
 Tourist *m* 260
 Touristenattraktion *f* 260
 Touristenbus *m* 197
 Touristeninformation *f* 261
 Trab *m* 243
 Trabenrennen *n* 243
 Tragbahre *f* 94
 Tragebetten *n* 75
 Träger *m* 35, 186
 trägerlos 34
 Tragfläche *f* 210
 Tragflügelboot *n* 215
 trainieren 251
 Trainingsanzug *m* 31, 32
 Trainingsrad *n* 250
 Trainingsschuhe *m* 251
 Traktor *m* 182
 Tranchiergabel *f* 68
 Träne *f* 51
 Transfer *m* 223
 Transformator *m* 60
 Transmission *f* 202
 Trapez *n* 164
 Traubenkernöl *n* 134
 Traubensaft *m* 144
 traurig 25
 Trekking *n* 243
 Treppe *f* 59
 Treppenabsatz *m* 59
 Treppengeländer *n* 59
 Treppengitter *n* 75
 treten 207
 Trethebel *m* 61
 Tretmaschine *f* 250
 Triangel *m* 257
 Trichter *m* 166
 Triebwerk *n* 210
 Trifle *n* 141
 Trimester *n* 52
 Trinidad und Tobago 314
 Trittleiter *f* 82
 Trizeps *m* 16
 trocken 39, 41, 130, 145, 286, 321
 Trockenblumen *f* 111
 Trockendock *n* 217
 trocknen 76
 Trockner *m* 76
 Trog *m* 183
 Trommel *f* 258
 Trompete *f* 257
 Tropfen *m* 109
 Tropfer *m* 109, 167
 Tropfinfusion *f* 53
 Troposphäre *f* 286
 Trüffel *m* 113, 125
 Truthahn *m* 185, 293
 Tschad 317
 Tschechische Republik 316
 T-Shirt *n* 30, 33, 54
 Tuba *f* 257
 Tube *f* 311
 Tülle *f* 80
 Tulpe *f* 111
 Tunesien 317
 Tunfisch *m* 120
 Tür *f* 196, 209
 Turbolader *m* 203
 Türgriff *m* 200
 Türkei *f* 316
 Türkette *f* 59
 Türkis *m* 289
 Türklingel *f* 59
 Türklopper *m* 59
 Turkmenistan 318
 Türknauf *m* 59
 Turm *m* 272, 300
 Turmalin *m* 288
 Turmspitze *f* 300
 Türmsprung *m* 239
 Turnen *n* 235
 Turnerin *f* 235
 Turnierplatz *m* 243
 Türriegel *m* 59
 Türverriegelung *f* 200
 Tüte *f* 311
 Typen *m* 205
U
 U-Bahn *m* 209
 U-Bahnplan *m* 209
 Übelkeit *f* 44
 über 320
 überbelichtet 271
 Überdach *n* 266
 Überführung *f* 194
 Übergepäck *n* 212
 überholen 195
 Überholspur *f* 194
 Überlauf *m* 61
 übermorgen 307
 Übernachtung mit Frühstück *f* 101
 Überpar *n* 233
 überrascht 25
 Überschwemmung *f* 287
 Überweisung *f* 49
 U-Boot *n* 215
 Übungen *f* 251
 Übungsschwung *m* 233
 Ufer *n* 284
 Uganda 317
 Uhr *f* 36
 Ukraine *f* 316
 Ulme *f* 296
 Ultraleichtflugzeug *n* 211
 Ultraschall *m* 52
 Ultraschallaufnahme *f* 52
 Ultraviolettstrahlen *m* 286
 um 320
 Umfang *m* 164
 Umhängetasche *f* 37
 Umlaufbahn *f* 280
 Umleitung *f* 195
 umpflanzen 91
 Umschlag *m* 98
 umsteigen 209
 Umwelt *f* 280
 Umzug *m* 27
 Unentschieden *n* 223
 Unfall *m* 46
 Ungarn 316
 ungesalzen 137
 ungültige Schlag *m* 228
 Uniform *f* 94, 189
 Universität *f* 299
 Universum *n* 280
 Unkraut *n* 86
 Unkrautvernichter *m* 91
 unpasteurisiert 137
 unscharf 271
 unschuldig 181
 unsichere Fangen des
 Balls *n* 220
 unter 320
 Unterarm *m* 12
 unterbrochen 99
 untere Kuchenteil *m* 141
 Unterführung *f* 194
 Untergrund *m* 91
 Unterhemd *n* 33, 35
 Unterpar *n* 233
 Unterrock *m* 35
 Unterschrift *f* 96, 98
 Übersetzer *m* 150
 Untersuchung *f* 45, 49
 Unterwäsche *f* 32, 35
 Unze *f* 310
 Uranus *m* 280
 Urlaub *m* 212
 Urlaubsprospekt *m* 212
 Urologie *f* 49
 Urteil *n* 181
 Uruguay 315
 Usbekistan 318
V
 Vanille *f* 132
 Vanillepudding *m* 140
 Vanuatu 319
 Vase *f* 63
 Vater *m* 22
 Vatikanstadt *f* 316
 V-Ausschnitt *m* 33
 vegetarische
 Hamburger *m* 155
 Vene *f* 19
 Venezuela 315
 Ventil *n* 207
 Ventilator *m* 60, 202
 Venus *f* 280
 Venusmuschel *f* 121
 Verankerung *f* 217
 Veranstaltungen *f* 243
 verarbeiteten
 Getreidearten *f* 130
 verärgert 25
 Verband *m* 47
 verbinden 177
 verbleit 199
 Verbrechen *n* 94
 verdrängen *m* 94, 181
 Verdauungssystem *n* 19
 Verdeck *n* 75
 Verdünnungsmittel *n* 83
 Vereinigte Arabische
 Emirate 318
 Vereinigtes Königreich *n* 316
 Vereinigten Staaten
 von Amerika 314
 Verfallsdatum *n* 109
 Verfügung *f* 180
 Vergiftung *f* 46
 Vergnügungspark *m* 262
 vergrößern *f* 172
 Vergrößerung *f* 271
 Verkäufer *m* 104
 Verkäuferin *f* 188
 Verkaufsabteilung *f* 175

- Verkehr *m* 194
 Verkehrsampel *f* 194
 Verkehrsflugzeug *n* 210, 212
 Verkehrsinsel *f* 194
 Verkehrspolizist *m* 195
 Verkehrsschilder *n* 195
 Verkehrsstau *m* 195
 verkleinern *f* 172
 Verkühlung *f* 44
 verlängern 168
 verlängerte Limousine *f* 199
 Verlängerung *f* 223
 Verlängerungsschnur *f* 78
 verlegen 25
 Verletzung *f* 46
 verlieren 273
 Verlierer *m* 273
 Verlobte *m* 24
 Verlobte *f* 24
 Verlobten *m, f* 24
 vermehren 91
 Vermieter *m* 58
 Vermittlung *f* 99
 Verordnung *f* 109
 verputzen 82
 verrühren 67, 138
 Verschluss *m* 36
 Versicherung *f* 203
 Versiegelungsmittel *n* 83
 Versorgungsfahrzeug *n* 212
 Verspätung *f* 209
 Verstärker *m* 268
 Verstauchung *f* 46
 verstellbare
 Schraubenschlüssel *m* 80
 Versuch *m* 166, 221
 Verteidiger *m* 223
 Verteidigung *f* 181, 220
 Verteidigungszone *f* 224
 Verteiler *m* 203
 Verwandten *m* 23
 verwirrt 25
 Vibraphon *n* 257
 Videospiele *n* 269
 Vieh *n* 183, 185
 vier 308
 vierhundert 308
 vierter 309
 viertürig 200
 vierzehn 308
 vierzehn Tage 307
 vierzehnter 309
 vierzig 308
 vierzig Minuten 304
 vierzigster 309
 Vietnam 318
 Violinschlüssel *m* 256
 Virus *m* 44
 Visier *n* 205
 Visum *n* 213
 Vitamintabletten *f* 108
 Vögel *m* 292
 Vögelbeobachten *n* 263
 Vogelscheuche *f* 184
 Volant *m* 71
 voll 266, 321
 Voll tanken, bitte 199
 Volley *m* 231
 Volleyball *m* 227
 Vollkorn- 131
 Vollkornbrot *n* 139
 Vollkornmehl *n* 138
 Vollmilch *f* 136
 Vollmond *m* 280
 Vollpension *f* 101
 Volumen *n* 165, 311
 vom Abschlag spielen 233
 von Bord gehen 217
 von, aus 320
 vor 320
 vorbestellen 168
 Vordach *n* 58
 vordere Backenzahn *m* 50
 Vorderrad *n* 196
 Vorderzwiessel *m* 242
 Vorfeld *n* 212
 vorgeburtlich 52
 vorgestern 307
 Vorhand *f* 231
 Vorhang *m* 63, 254
 Vorhaut *f* 21
 vorher aufgezeichnet 178
 Vorkriegsmodell *n* 199
 Vorladung *f* 180
 Vorlauf *m* 269
 Vorort *m* 299
 Vorschlaghammer *m* 187
 Vorspeise *f* 153
 Vorteil *m* 230
 vorzeitig 52
 Vulkan *m* 283
- W**
 Waage *f* 53, 98, 118, 310
 Waagschale *f* 310
 Wachtel *f* 119
 Wachtelei *n* 137
 Wächter *m* 189
 Wade *f* 13
 Wadenbein *n* 17
 Wadenmuskel *m* 16
 Waffeln *f* 157
 Wagen *m* 208
 Wagenheber *m* 203
 Wagentypen *m* 199
 wählen 99
 Wal *m* 290
 Wald *m* 285
 Walnuss *f* 129
 Walnussöl *n* 134
 Walross *n* 290
 Walze *f* 187
 Wandern *n* 263
 Wanderschuh *m* 37
 Wanderschuhe *m* 267
 Wandlampe *f* 62
 Wanne *f* 83
 Warenlager *n* 216
 Warenregal *n* 106
 warm 286
 Wärmflasche *f* 70
 Warnlichter *n* 201
 Wartehäuschen *n* 197
 Warteraum *m* 45
 Waschautomat mit Trockner *m* 76
 Waschbär *m* 290
 Waschbecken *n* 38, 72
 Wäsche *f* 76, 105
 Wäschediener *m* 101
 Wäscheklammer *f* 76
 Wäschekorb *m* 76
 Wäscheleine *f* 76
 waschen 38
 Wascheschleuder *f* 76
 Waschmaschine *f* 76
 Waschmittel *n* 77
 Waschsalon *m* 115
 Wasser *n* 144, 238
 Wasser treten 239
 Wasserball *m* 239, 265
 Wasserbehandlung *f* 55
 Wasserfall *m* 285
 Wasserflasche *f* 206, 267
 Wasserflugzeug *n* 211
 Wassergarten *m* 84
 Wasserglas *n* 65
 Wasserhahn *m* 66
 Wasserhindernis *n* 232
 Wasserkastanie *f* 124
 Wassermelone *f* 127
 Wassermotorradsport *m* 241
 Wasserpflanze *f* 86
 Wasserraum *m* 61
 Wasserreis *m* 130
 Wasserschildkröte *f* 293
 Wasserski *n* 241
 Wasserskifahrer *m* 241
 Wassersport *m* 241
 Wasserstrahl *m* 95
 Wasserwaage *f* 80, 187
 Watstiefel *m* 244
 Wattebällchen *n* 41
 Wattieren *n* 277
 WC *n* 61
 Weben *n* 277
 Web-Site *f* 177
 Webstuhl *m* 277
 Wechselkurs *m* 97
 Wechselstrom *m* 60
 Wechselstube *f* 97
 Wecker *m* 70
 Wedge *n* 233
 Weg *m* 58, 85
 Wegschnecke *f* 295
 Wegwerf- 109
 Wegwerfwinkel *f* 30
 Wehe *f* 52
 weiblich 20
 weich 129, 321
 weiche Brötchen *n* 139
 Weichholz *n* 79
 Weichkäse *m* 136
 Weichspüler *m* 76
 Weide *f* 182, 296
 Weihnachten *n* 27
 Wein *m* 145, 151
 Weinberg *m* 183
 Weinbrand *m* 145
 weinen 25
 Weinessig *m* 135
 Weinglas *n* 65
 Weinhandlung *f* 115
 Weinkarte *f* 152
 Weinstock *m* 183
 weiß 39, 145, 272, 274
 Weißbrot *n* 139
 weiße Fleisch *n* 118
 weiße Haut *f* 126
 weiße Johannisbeere *f* 127
 weiße Reis *m* 130
 weiße Schokolade *f* 113
 weißen Bohnen *f* 131
 Weißfisch *m* 120
 Weißrussland 316
 weit 320
 Weitsichtigkeit *f* 51
 Weitsprung *m* 235
 Weizen *m* 130, 184
 Weizenmehl *n* 138
 Weizenschrot *m* 130
 Welle *f* 241, 264
 Wellenlänge *f* 179
 Wellenreiten *n* 241
 Welpen *m* 290
 Weltkarte *f* 312
 Weltraum *m* 280
 Wendekreis des Krebses *m* 283
 Wendekreis des Steinbocks *m* 283
 Werbung *f* 269
 werdende Mutter *f* 52
 werfen 221, 225, 227, 229
 Werfer *m* 225, 229
 Werferplatte *f* 228
 Werft *f* 217
 Werkbank *f* 78
 Werkstatt *f* 199, 203
 Werktag *m* 306
 Werkzeuge *n* 187
 Werkzeuggestell *n* 78
 Werkzeuggürtel *m* 186
 Werkzeugkasten *m* 80
 Werkzeuggestelle *f* 177
 Wertpapiere *n* 97
 Wespe *f* 295
 Weste *f* 33
 Westen *m* 312
 Western *m* 255
 Westsahara 317
 Wette *f* 273
 Wetter *n* 286
 Wetzstein *m* 81
 Whisky *m* 145
 Wickelmatte *f* 74
 Wickelraum *m* 104
 Widerhaken *m* 244
 Wiederbelebung *f* 47
 wiegen 310
 Wiese *f* 285
 Wild *n* 118, 119
 Wildwasser *n* 240
 Wimper *f* 14, 51
 Wimperntusche *f* 40
 Wind *m* 241, 286
 Windel *f* 75
 windig 286
 Windpocken *f* 44
 Windschutz *m* 265
 Windschutzscheibe *f* 198, 205
 Windsurfer *m* 241
 Windsurfing *n* 241
 Winkel *m* 164
 Winkelmesser *m* 165
 Winter *m* 31, 307
 Wintersport *m* 247
 Wippe *f* 263
 Wirbel *m* 259
 Wirbellosen *n* 295
 Wirbelsäule *f* 17
 Wirtschaftsprüfer *m* 97, 190
 Wirtschaftswissenschaft *f* 169
 wischen 77
 Wissenschaft *f* 166
 Wissenschaftlerin *f* 190
 WLAN 269
 Woche *f* 306
 Wochenende *n* 306
 wöchentlich 307
 Wodka *m* 145
 Wodka mit Orangensaft *m* 151
 Wohnblock *m* 59, 298
 Wohngegend *f* 299
 Wohnmobil *n* 266
 Wohnung *f* 59
 Wohnwagen *m* 266
 Wohnzimmer *n* 62
 Wok *m* 69
 Wolf *m* 290
 Wolke *f* 287
 Wolkenkratzer *m* 299, 300
 Wolle *f* 277
 Wörterbuch *n* 163
 Wunde *f* 46
 Wundsalbe *f* 74
 Wurf *m* 237
 Würfel *m* 164, 272
 Wurflinie *f* 225
 Wurm *m* 295
 Wurst *f* 155
 Würstchen *n* 118, 157
 Wurzel *f* 124, 296
 Wüste *f* 285

Y

Yard *n* 310
 Yoga *n* 54

- Z**
 Zahlen *f* 308
 zählen 165
 Zähler *m* 165
 Zahlung *f* 96
 Zahn *m* 50
 Zahnarzt *m* 50
 Zahnärztin *f* 189
 Zahnbelag *m* 50
 Zahnbürste *f* 72
 Zahnfleisch *n* 50
 Zahnfüllung *f* 50
 Zahnpasta *f* 72
 Zahnpflege *f* 72, 108
 Zahnprothese *f* 50
 Zahnrad *m* 206
 Zahnschmelz *m* 50
 Zahnschmerzen *m* 50
 Zahnseide *f* 50, 72
 Zahnspange *f* 50
 Zahnwurzel *f* 50
 Zange *f* 167
 Zäpfchen *n* 109
 Zapfhahn *m* 150
 Zapfsäule *f* 199
 Zaumzeug *n* 242
 Zaun *m* 85, 182
 Zebra *n* 291
 Zeder *f* 296
 Zeh *m* 15
 Zehe *f* 125
 Zehennagel *m* 15
 zehn 308
 zehntausend 309
 zehnter 309
- Zeichendreieck *n* 165
 Zeichentrickfilm *m* 178, 255
 Zeichnen *n* 275
 zeichnen 162
 Zeigefinger *m* 15
 Zeit *f* 234
 Zeiten *f* 261
 Zeitmesser *m* 166
 Zeitschrift *f* 112, 168
 Zeitschriften *f* 107
 Zeitung *f* 112
 Zeitungshändler *m* 112
 Zelt *n* 267
 Zeltboden *m* 267
 zelten 266
 Zeltplatz *m* 266
 Zeltplätze frei 266
 Zeltspannleine *f* 266
 Zeltstange *f* 266
 Zement *m* 186
 Zentimeter *m* 310
 Zentimetermaß *n* 276
 Zentralafrikanische Republik 317
 Zentrale *f* 175
 zerbrechlich 98
 zerstoßen 132
 Zeuge *m* 180
 Zicklein *n* 185
 Ziege *f* 185
 Ziegelstein *m* 187
 Ziegenkäse *m* 142
 Ziegenmilch *f* 136
 ziehen 91
 Ziellinie *f* 234
 Zielscheibe *f* 249
- Zier- 87
 Zierstrauch *m* 87
 Zigaretten *f* 112
 Zigarre *f* 112
 Zimmer *n* 58, 100
 Zimmernummer *f* 100
 Zimmerreinigung *f* 101
 Zimmerschlüssel *m* 100
 Zimmerservice *m* 101
 Zimt *m* 133
 Zink *n* 289
 Zinn *n* 289
 Zinssatz *m* 96
 Zirkel *m* 165
 Zirkeltraining *n* 251
 Zitrone *f* 126
 Zitronenaufstrich *m* 134
 Zitronengras *n* 133
 Zitrusfrüchte *f* 126
 Zoll *m* 212, 310
 Zollamt *n* 216
 Zone *f* 315
 Zoo *m* 262
 Zoologie *f* 169
 Zoom *n* 270
 Zopf *m* 39
 zu 320
 zu, nach 320
 zubereitet 121
 Zubereitung *f* 159
 Zubringer *m* 197
 Zucchini *f* 125
 züchten 91
 Zuckerguss *m* 141
 Zuckerkrankheit *f* 44
 Zuckerrohr *n* 184
 Zufahrtsstraße *f* 194
- Zufahrtsstraße *f* 216
 Zug *m* 208, 239, 273
 Zugabe *f* 255
 Zügel *m* 242
 Zugfenster *n* 209
 Zugtypen *m* 208
 Zuleitung *f* 61
 zum Mitnehmen 154
 Zündkerze *f* 203
 Zündung *f* 200
 Zunge *f* 19, 37, 118
 zur Schule kommen 26
 Zuschauer *m* 233
 Zustellung *f* 98
 zwanzig 308
 zwanzig Minuten 304
 zwanzigster 309
 zwanzigttausend 309
 zwei 308
 zwei Uhr 304
 Zweibettzimmer *n* 100
 Zweig *m* 296
 Zweigstelle *f* 175
 zweihundert 308
 zweijährig 86
 Zweispännerrennen *n* 243
 zweitausend 307
 zweitausendeins 307
 zweitausendzwei 307
 zweite Etage *f* 104
 zweite Rang *m* 254
 zweiter 309
 zweitürig 200
 zweiundzwanzig 308
 zweiundzwanzigster 309
 Zwerchfell *n* 19
 Zwiebel *f* 86, 124
- Zwillinge *m* 23
 Zwinge *f* 78
 Zwirn *m* 89
 zwischen 320
 Zwischenrippenmuskel *m* 16
 zwölf 308
 Zwölffingerdarm *m* 18
 zwölfster 309
 Zylinder *m* 164
 Zylinderkopf *m* 202
 Zypern 316

englisches Register • English index

A

- à la carte 152
 abdomen 12
 abdominals 16
 above 320
 acacia 110
 accelerator 200
 accessories 36, 38
 accident 46
 account number 96
 accountant 97, 190
 accounts department 175
 accused 180
 ace 230, 273
 Achilles tendon 16
 acorn squash 125
 acquaintance 24
 acquitted 181
 across 320
 acrylic paints 274
 actions 237, 229, 227, 233, 183
 activities 263, 245, 162, 77
 actor 254, 191
 actors 179
 actress 254
 acupressure 55
 acupuncture 55
 Adam's apple 19
 add v 165
 address 98
 adhesive tape 47
 adjustable wrench 80
 admission charge 260
 admissions office 168
 admitted 48
 aduki beans 131
 adult 23
 advantage 230
 adventure 255
 advertisement 269
 aerate v 91
 Afghanistan 318
 Africa 317
 after 320
 afternoon 305
 aftershave 73
 after-sun 108
 agate 289
 agenda 174
 aikido 236
 aileron 210
 air bag 201
 air conditioning 200
 air cylinder 239
 air filter 202, 204
 air letter 98
 air mattress 267
 air vent 210
 aircraft 210
 aircraft carrier 215
 airliner 210, 212
 airport 212
 aisle 106, 168, 210, 254
 alarm clock 70
 Alaska 314
 Albania 316
 alcoholic drinks 145
 alfalfa 184
 Algeria 317
 all-purpose flour 139
 allergy 44
 alley 298
 alligator 293
 alligator clip 167
 allspice 132
 almond 129
 almond oil 134
 almonds 151
 along 320
 alpine 87
 alpine skiing 247
 alternating current 60
 alternative therapy 54
 alternator 203
 altitude 211
 aluminum 289
 Amazonia 312
 ambulance 94
 amethyst 288
 amniocentesis 52
 amniotic fluid 52
 amount 96
 amp 60
 amphibians 294
 amplifier 268
 analog (radio) 179
 anchor 214, 240
 Andes 312
 Andorra 316
 anesthetist 48
 angle 164
 angler 244
 Angola 317
 angry 25
 animals 292, 294
 animated film 255
 ankle 13, 15
 ankle-length 34
 anniversary 26
 annual 86, 307
 answer 163
 answer v 99, 163
 answering machine 99
 ant 295
 antenna 295
 antifreeze 199, 203
 Antigua and Barbuda 314
 anti-inflammatory 109
 antique shop 114
 antiseptic 47
 antiseptic wipe 47
 anti-wrinkle 41
 antler 291
 apartment building 298
 apéritif 153
 aperture dial 270
 apex 165
 app 99
 appeal 181
 appearance 30
 appendix 18
 applaud v 255
 apple 126
 apple corer 68
 apple juice 149
 appliances 66
 application 176
 appointment 45, 175
 apricot 126
 April 306
 apron 30, 50, 69, 212
 aquamarine 288
 Arabian Sea 313
 arc 164
 arch 15, 85, 301
 archery 249
 architect 190
 architecture 300
 architrave 301
 Arctic Circle 283
 Arctic Ocean 312
 area 165, 310
 areas 299
 arena 243
 Argentina 315
 arithmetic 165
 arm 13
 armband 238
 armchair 63
 Armenia 318
 armpit 13
 armrest 200, 210
 aromatherapy 55
 around 320
 arrangements 111
 arrest 94
 arrivals 213
 arrow 249
 art 162
 art college 169
 Art Deco 301
 art gallery 261
 art history 169
 Art Nouveau 301
 art shop 115
 artery 19
 artichoke 124
 artist 274
 arts and crafts 274, 276
 ash 283
 ashtray 150
 Asia 318
 asparagus 124
 asphalt 187
 assault 94
 assistant 24
 assisted delivery 53
 asteroid 280
 asthma 44
 astigmatism 51
 astronaut 281
 astronomy 281
 asymmetric bars 235
 at 320
 athlete 234
 athletic shoes 31, 251
 Atlantic Ocean 312
 ATM 97
 atmosphere 282, 286
 atrium 104
 attachment 177
 attack 220
 attack zone 224
 attend v 174
 attic 58
 attractions 261
 auburn 39
 audience 254
 August 306
 aunt 22
 aurora 286
 Australasia 319
 Australia 319
 Austria 316
 automatic 200
 automatic door 196
 automatic payment 96
 avalanche 247
 avenue 299
 avocado 128
 awning 148
 ax 95
 axle 205
 ayurveda 55
 Azerbaijan 318

B

- baby 23, 30
 baby bath 74
 baby care 74
 baby changing facilities 104
 baby monitor 75
 baby products 107
 baby sling 75
 back 13
 back brush 73
 back seat 200
 back up v 195
 backboard 226
 backdrop 254
 backgammon 272
 backhand 231
 backpack 31, 37, 267
 backslash 66
 backstroke 239
 backswing 233
 bacon 118, 119, 157
 bad 321
 badge 94, 189
 badminton 231
 bag 311
 bagel 139
 baggage claim 213
 baggage trailer 212
 bags 37
 baguette 138
 Bahamas 314
 bail 181
 bailiff 180
 bait 244
 bait v 245
 bake v 67, 138
 baked 159
 baker 139
 baker's 114
 bakery 107, 114, 138
 baking 69
 baking sheet 69
 balance wheel 276
 balcony 59, 254
 bald 39
 bale 184
 Balearic Islands 316
 ball 15, 75, 221, 224, 226, 228, 230
 ball boy 231
 ballet 255
 balsamic vinegar 135
 Baltic Sea 313
 bamboo 86, 122
 banana 128
 bandage 47
 Bangladesh 318
 banister 59
 bank 96, 284
 bank charge 96
 bank manager 96
 bank transfer 96
 bar 150, 152, 250, 256, 311
 bar code 106
 bar counter 150
 bar mitzvah 26
 bar snacks 151
 bar stool 150
 barb 244
 Barbados 314
 barbecue 267
 barber 39, 188
 bark 296

- barley 130, 184
 barn 182
 baroque 301
 bars 74
 bartender 150, 191
 basalt 288
 base 164, 229
 base station 99
 baseball 228
 baseline 230
 baseman 228
 basement 58
 basil 133
 basket 106, 207, 226
 basket of fruit 126
 basketball 226
 basketball player 226
 basque 35
 bass clarinet 257
 bass clef 256
 bass guitar 258
 bassinet 74
 bassoon 257
 bat 225, 228, 231, 290
 bat v 225, 229
 bath mat 72
 bath towel 73
 bathrobe 31, 32, 73
 bathroom 72
 bathtub 72
 baton 235, 256
 batsman 225
 batter 228
 batteries 260
 battery 167, 202
 battery pack 78
 battleship 215
 bay leaf 133
 be born v 26
 beach 264
 beach bag 264
 beach ball 265
 beach hut 264
 beach towel 265
 beach umbrella 264
 beaker 167
 beam 186, 235
 bean sprout 122
 beans 131, 144
 bear 291
 beat 259
 beauty 40, 105
 beauty treatments 41
 bed 70
 bed and breakfast 101
 bed linen 71
 bedding 74
 bedroom 70
 bedside lamp 70
 bedspread 70
 bee 295
 beech 296
 beef 118
 beer 145, 151
 beer tap 150
 beetle 295
 beet 125
 before 320
 beginning 321
 behind 320
 Belarus 316
 Belgium 316
 Belize 314
 bell 197
 below 320
 belt 32, 36, 236
 bench 250, 262
 Benin 317
 berry 296
 beside 320
 bet 273
 between 320
 beyond 320
 Bhutan 318
 biathlon 247
 bib 30
 biceps curl 251
 biceps 16
 bicycle 206
 bidet 72
 biennial 86
 bifocal 51
 big toe 15
 bike rack 207
 bikini 264
 bill 152, 293
 binoculars 281
 biology 162
 biplane 211
 birch 296
 bird-watching 263
 birds 292
 birth 52
 birth weight 53
 birth certificate 26
 birthday 27
 birthday cake 141
 birthday candles 141
 birthday party 27
 bishop 272
 bit 242
 bit brace 78
 bite 46
 bite v 245
 bitter 124, 145
 black 39, 272, 274
 black belt 237
 black coffee 148
 black currant 127
 black hole 280
 black olive 143
 black pudding 157
 Black Sea 313
 black tea 149
 blackberry 127
 blackboard 162
 black-eyed beans 131
 bladder 20
 blade 60, 66, 78, 89
 blanket 71, 74
 blazer 33
 bleach 77
 blender 66
 blister 46
 block 237
 block v 227
 blonde 39
 blood pressure 44
 blood pressure gauge 45
 blood test 48
 blouse 34
 blow-dry v 38
 blow out v 141
 blowhole 290
 blue 274
 blue cheese 136
 bluebells 297
 blueberry 127
 blues 259
 blusher 40
 board 241
 board v 217
 board games 272
 boarding pass 213
 boardwalk 265
 bob 39
 bobbin 276
 bobsled 247
 body 12
 body lotion 73
 body systems 19
 bodywork 202
 boil v 67
 boiled egg 137, 157
 Bolivia 315
 bollard 214, 298
 bolt 59
 bomber 211
 bone 17, 119, 121
 bone meal 88
 boned 121
 bongos 257
 book 168
 bookstore 115
 bookshelf 63, 168
 boom 95, 240
 booster 281
 boot 37
 booties 30
 bored 25
 borrow v 168
 Bosnia and Herzegovina 316
 Botswana 317
 bottle 61, 75, 135, 311
 bottle opener 68, 150
 bottled foods 134
 bottled water 144
 bottom tier 141
 boundary line 225
 bouquet 35, 111
 bouquet garni 132
 bout 237
 boutique 115
 bow 240, 249
 bow tie 36
 bowl 61, 65, 112
 bowl v 225
 bowler 225
 bowling 249
 bowling ball 249
 box 254
 box file 173
 box of chocolates 113
 box of tissues 70
 box office 255
 boxer shorts 33
 boxercise 251
 boxing 236
 boxing gloves 237
 boxing ring 237
 boy 23
 boyfriend 24
 bra 35
 braces 50
 bracelet 36
 braid 39
 brain 19
 brake 200, 204, 206
 brake v 207
 brake block 207
 brake fluid reservoir 202
 brake lever 207
 brake pedal 205
 bran 130
 branch 296
 brandy 145
 brass 256
 Brazil 315
 Brazil nut 129
 bread 157
 bread flour 139
 bread knife 68
 bread roll 143
 breadcrumbs 139
 breadfruit 124
 breads 138
 break a record v 234
 break water v 52
 breakdown 203
 breakfast 64, 156
 breakfast buffet 156
 breakfast cereals 107
 breakfast table 156
 breakfast tray 101
 breast 12, 119
 breast pump 53
 breastbone 17
 breastfeed v 53
 breaststroke 239
 breathing 47
 breech 52
 brick 187
 bridge 15, 214, 258, 273, 300
 bridle 242
 bridle path 263
 brie 142
 briefcase 37
 briefs 33, 35
 brioche 157
 broadcast 179
 broadcast v 178
 broccoli 123
 brochure 96, 175
 brogue 37
 broil v 67
 bronze 235
 brooch 36
 broom 77
 broth 158
 brother 22
 brother-in-law 23
 browband 242
 brown 274
 brown bread 139, 149
 brown flour 138
 brown lentils 131
 brown rice 130
 browse v 177
 browser 177
 bruise 46
 Brunei 319
 Brunette 39
 brush 38, 40, 77, 83, 274
 brush v 38, 50
 Brussels sprout 122
 bubble bath 73
 buckle 36
 bud 111, 297
 buffet 152
 build v 186
 building site 186
 buildings 299
 built-in wardrobe 71
 bulb 86
 Bulgaria 316
 bull 185
 bulldog clip 173
 bullnose pliers 80
 bullseye 273
 bumper 74, 198
 bun 39, 140, 139, 155
 bunch 111
 bungalow 58
 bungee jumping 248
 bunker 232
 bunsen burner 166
 buoy 217
 bureau de change 97
 burger 154
 burger bar 154
 burger meal 154
 burglar alarm 58
 burglary 94
 Burkina Faso 317
 Burma (Myanmar) 318
 burn 46
 burner 67

- Burundi 317
 bus 196
 bus driver 190
 bus stop 197
 bus station 197
 bus stop 197, 299
 bus ticket 197
 buses 196
 business 175
 business class 211
 business deal 175
 business lunch 175
 business partner 24
 business suit 32
 business trip 175
 businessman 175
 businesswoman 175
 busy 99
 butcher 118, 188
 butcher shop 114
 butter 137, 156
 butter beans 131
 buttercup 297
 butterfly 239, 295
 buttermilk 137
 butternut squash 125
 buttock 13, 16
 button 32
 buttonhole 32
 buttress 301
 by 320
 by airmail 98
 bytes 176
- C**
 cab 95
 cab driver 190
 cabbage 123
 cabin 210, 214
 Cabinda 317
 cable 79, 207
 cable car 246
 cable television 269
 cactus 87
 caddy 233
 cesarean section 52
 café 148, 262
 cafeteria 168
 cafetière 65
 cake pan 69
 cakes 140
 calcite 289
 calcium 109
 calculator 165
 calendar 306
 calf 13, 16, 185
 call button 48
 calyx 297
 cam belt 203
 Cambodia 318
 camcorder 260, 269
 camel 291
 camembert 142
 camera 178, 260, 270
 camera case 271
 camera crane 178
 camera shop 115
 cameraman 178
 cameraphone 270
 Cameroon 317
 camisole 35
 camp v 266
 camp bed 266
 campari 145
 camper van 266
 campfire 266
 camping 266
 camping stove 267
 campground 266
 campus 168
 can 145, 289, 311
 can opener 68
 Canada 314
 canary 292
 candied fruit 129
 candy 113
 candy store 113
 cane 91
 canes 89
 canine 50
 canned drink 154
 canned food 107
 canoe 214
 canoeing 241
 canola oil 135
 canter 243
 canvas 274
 cap 21, 36, 238
 capacity 311
 cape gooseberry 128
 capers 143
 capital 315
 capoeira 237
 cappuccino 148
 capsize v 241
 capsule 109
 captain 214
 car 198, 200
 car accident 203
 car rental 213
 car seat 198, 207
 car stereo 201
 car wash 198
 caramel 113
 caraway 131
 card 27
 card slot 97
 cardamom 132
 cardboard 275
 cardigan 32
 cardiology 49
 cardiovascular 19
 cards 273
 cargo 216
 Caribbean Sea 312
 carnation 110
 carnival 27
 carousel 212
 carpenter 188
 carpentry bits 80
 carpet 71
 carriage race 243
 carrier 75, 204
 carrot 124
 carry-on luggage 211, 213
 cart 48, 100, 106, 208, 213
 cartilage 17
 cartoon 311
 cartoon 178
 carve v 79
 carving fork 68
 case 51
 cash v 97
 cashew 129
 cashews 151
 cashier 96, 106
 casino 261
 Caspian Sea 313
 cassava 124
 casserole dish 69
 cassette player 269
 cassette tape 269
 cast 254
 cast v 245
 castle 300
 casual 34
 casual wear 33
 cat 290
 catamaran 215
 cataract 51
 catch v 220, 227, 229, 245
 catcher 229
 caterpillar 295
 cathedral 300
 catheter 53
 cauliflower 124
 cave 284
 CD 269
 CD player 268
 cedar 296
 ceiling 62
 celebration 140
 celebration cakes 141
 celebrations 27
 celeriac 124
 celery 122
 cell 94, 181
 cell phone 99
 cello 256
 cement 186
 cement mixer 186
 centimeter 310
 centipede 295
 Central African Republic 317
 central reservation 194
 center 164
 center circle 222, 224, 226
 center field 228
 center line 226
 centerboard 241
 century 307
 CEO 175
 ceramic range 66
 cereal 130, 156
 cervical vertebrae 17
 cervix 20, 52
 Chad 317
 chain 36, 206
 chair 64
 chair v 174
 chairlift 246
 chalk 85, 162, 288
 chamber 283
 chamomile tea 149
 champagne 145
 championship 230
 change v 209
 change a tire v 203
 change channels v 269
 change gears v 207
 changing mat 74
 changing room 104
 channel 178
 charcoal 266, 275
 charge 94, 180
 chart 48
 chassis 203
 check 96
 checkbook 96
 checkers 272
 check-in v 212
 check-in desk 213
 checking account 96
 checkout 106
 checkup 50
 cheddar 142
 cheek 14
 cheerleader 220
 cheese 136, 156
 chef 152, 190
 chef's hat 190
 chemistry 162
 cherry 126
 cherry tomato 124
 chess 272
 chessboard 272
 chest 12
 chest of drawers 70
 chest press 251
 chestnut 129
 chicken coop 113
 chick 185
 chicken 119, 185
 chicken burger 155
 chicken coop 185
 chicken nuggets 155
 chicken pox 44
 chicory 122
 child 23, 31
 child lock 75
 childbirth 53
 children 23
 children's clothing 30
 children's department 104
 children's meal 153
 children's ward 48
 Chile 315
 chili pepper 124, 132, 143
 chill 44
 chimney 58
 chin 14
 China 318
 china 105
 chip v 233
 chips 113, 151
 chipboard 79
 chiropractic 54
 chisel 81, 275
 chives 133
 chocolate 113
 chocolate bar 113
 chocolate cake 140
 chocolate chip 141
 chocolate-coated 140
 chocolate milkshake 149
 chocolate spread 135
 choir 301
 choke v 47
 chop 119, 237
 chorizo 143
 choux pastry 140
 christening 26
 Christmas 27
 chrysanthemum 110
 chuck 78
 church 298, 300
 chutney 134
 cider 145
 cider vinegar 135
 cigar 112
 cigarettes 112
 cilantro 133
 cinnamon 133
 circle 165, 254
 circular saw 78
 circuit training 251
 circulation desk 168
 circumference 164
 citrus fruit 126
 city 299
 clam 121
 clamp 78, 166
 clamp stand 166
 clapper board 179
 clarinet 257
 clasp 36
 classical music 255, 259
 classroom 162
 claw 291
 clay 85, 275
 clean v 77
 clean clothes 76

- cleaned 121
 cleaner 188
 cleaning equipment 77
 cleaning fluid 51
 cleanser 41
 clear honey 134
 cleat 240
 cleaver 68
 clementine 126
 client 38, 175, 180
 cliff 285
 climber 87
 climbing frame 263
 clinic 48, 168
 clipboard 173
 clitoris 20
 clock radio 70
 closed 260, 321
 cloth diaper 30
 clothesline 76
 clothespin 76
 clothing 205
 cloud 287
 cloudy 286
 clove 125
 clover 297
 cloves 133
 club 273
 club sandwich 155
 clubhouse 232
 clutch 200, 204
 coach 196
 coal 288
 coast 285
 coaster 150
 coastguard 217
 coat 32
 coat hanger 70
 cockatoo 293
 cockle 121
 cockpit 210
 cockroach 295
 cocktail 151
 cocktail shaker 150
 cocoa powder 148
 coconut 129
 cocoon 295
 cod 120
 coffee 144, 148, 153,
 156, 184
 coffee cup 65
 coffee machine 148, 150
 coffee milkshake 149
 coffee spoon 153
 coffee table 62
 cog 206
 coin 97
 coin phone 99
 coin return 99
 cola 144
 colander 68
 cold 44, 286, 321
 cold faucet 72
 cold-pressed oil 135
 collage 275
 collar 32
 collarbone 17
 colleague 24
 collect call 99
 collection 98
 college 168
 cologne 41
 Colombia 315
 colony 315
 colored pencil 163
 colors 39, 274
 comb 38
 comb v 38
 combat sports 236
 combine 182
 comedy 255
 comforter 71
 comet 280
 comic 112
 commis chef 152
 commission 97
 communications 98
 commuter 208
 Comoros 317
 compact 40
 compact car 199
 company 175
 compartment 209
 compass 165, 312, 240
 complaint 94
 complexion 41
 composite 181
 compost 88
 compost pile 85
 computer 176
 concealer 40
 conceive v 20
 conception 52
 concert 255, 258
 concourse 209
 concrete block 187
 concussion 46
 condensed milk 136
 conditioner 38
 condom 21
 conductor 256
 cone 164, 187
 confectionery 107, 113
 confident 25
 confused 25
 conglomerate 288
 Congo 317
 conifer 86
 connect v 177
 connection 212
 conning tower 215
 console 269
 constellation 281
 construction 186
 construction worker 186,
 188
 consultant 49
 consultation 45
 contact lenses 51
 container 216, 311
 container port 216
 container ship 215
 continent 282, 315
 contraception 21, 52
 contraction 52
 control tower 212
 controller 269
 controls 201, 204
 convenience food 107
 convertible 199
 conveyer belt 106
 cooked meat 118, 143
 cookies 113, 141
 cooking 67
 coolant reservoir 202
 cooling rack 69
 co-pilot 211
 copper 289
 copy v 172
 cor anglais 257
 coral reef 285
 cordless drill 78
 cordless phone 99
 core 127
 cork 134
 corkscrew 150
 corn 122, 130, 184
 corn bread 139
 corn oil 135
 cornea 51
 corner 223
 corner flag 223
 cornice 300
 corset 35
 Corsica 316
 Costa Rica 314
 costume 255
 cottage cheese 136
 cottage garden 84
 cotton 184, 277
 cotton balls 41
 cough 44
 cough drop 109
 cough medicine 108
 counselor 55
 count v 165
 counter 96, 98, 100,
 142, 272
 countertop 66
 country 259, 315
 couple 24
 courier 99
 courses 153
 court 226
 court case 180
 court clerk 180
 court date 180
 courtroom 180
 courtyard 58, 84
 couscous 130
 cousin 22
 coverall 30
 cow 185
 cow's milk 136
 crab 121, 295
 cracked wheat 130
 cradle 95
 craft knife 82
 crafts 275
 cramp 239
 cramps 44
 cranberry 127
 crane 187, 216, 292
 crater 283
 crayfish 121
 cream 109, 137, 140,
 157
 cream cheese 136
 cream pie 141
 crease 225
 credit card 96
 creel 245
 creeper 87
 crème caramel 141
 crème patisserie 140
 crêpe 155, 157
 crescent moon 280
 crew 241
 crew hatch 281
 crib 74
 cricket 225, 295
 cricket ball 225
 cricketer 225
 crime 94
 criminal 181
 criminal record 181
 crisp 127
 crispbread 139, 156
 crisper 67
 Croatia 316
 crochet 277
 crochet hook 277
 crockery 64
 crockery and cutlery 65
 crocodile 293
 croissant 156
 crop 39, 183
 crop farm 183
 crops 184
 crossbar 207, 222, 235
 cross-country skiing 247
 cross-trainer 250
 crosswalk 195
 crow 292
 crown 50
 crucible 166
 crushed 132
 crust 139, 282
 cry v 25
 crystal healing 55
 Cuba 314
 cube 164
 cucumber 125
 cuff 32, 45
 cufflink 36
 cultivate v 91
 cultivator 182
 cumin 132
 curb 298
 cured 118, 159, 143
 curler 38
 curling 247
 curly 39
 currant 129
 curry 158
 curry powder 132
 curtain 63, 254
 curved 165
 cushion 62
 custard 140
 customer 96, 104, 106,
 152
 customer service
 department 175
 customer services 104
 customs 212
 customs house 216
 cut 46
 cut v 38, 79, 277
 cuticle 15
 cutlery 64
 cuts 119
 cutting 91
 cutting board 68
 cuttlefish 121
 cycle v 207
 cycle lane 206
 cycling 263
 cylinder 164
 cylinder head 202
 cymbals 257
 Cyprus 316
 Czech Republic 316

D

- daffodil 111
 dairy 107
 dairy farm 183
 dairy produce 136
 daisy 110, 297
 dam 300
 dance 259
 dance academy 169
 dancer 191
 dandelion 123, 297
 dandruff 39
 dark 41, 321
 darkroom 271
 darn v 277
 dartboard 273
 darts 273
 dashboard 201
 date 129, 306
 daughter 22

- daughter-in-law 22
dawn 305
day 305, 306
day after tomorrow 307
day before yesterday 307
dead ball line 221
deadhead v 91
deal v 273
debit card 96
decade 307
decay 50
December 306
deciduous 86
decimal 165
deck 214
deck chair 265
deck of cards 273
decking 85
decorating 82
decoration 141
decorator 82
deep end 239
deep-fried 159
deep-sea fishing 245
deer 291
defense 181, 220
defendant 181
defender 223
defending zone 224
defrost v 67
degree 169
delay 209
deli 107
delicatessen 142
delivery 52, 98
deltoid 16
Democratic Republic of the Congo 317
Denmark 316
denomination 97
denominator 165
dental care 108
dental floss 50, 72
dental hygiene 72
dental X-ray 50
dentist 50, 189
dentist's chair 50
dentures 50
deodorant 73, 108
department 169
department store 105
departments 49
departure lounge 213
departures 213
deposit v 96
deposit slips 96
depth 165
dermatology 49
descaled 121
desert 285
desiccated 129
designer 191, 277
desk 162, 172
desktop 177
dessert 153
desserts 140
dessert cart 152
dessert 213
detached 58
detective 94
detergent 77
detour 195
deuce 230
develop v 271
diabetes 44
diagonal 164
dial v 99
diameter 164
diamond 273, 288
diaper 75
diaper bag 75
diaper rash cream 74
diaphragm 19, 21
diarrhea 44, 109
dice 272
dictionary 163
die v 26
diesel 199
diesel train 208
difficult 321
dig v 90, 227
digestive 19
digital 269
digital (radio) 179
digital camera 270
digital projector 163
digital radio 268
dilation 52
dill 133
dimensions 165
dimple 15
dining car 209
dining room 64
dinner 64, 158
dinner plate 65
diopter 51
diploma 169
dipstick 202
direct current 60
directions 260
director 254
directory assistance 99
dirt bike 205
dirty laundry 76
disabled parking 195
discharged 48
disconnected 99
discus 234
discuss v 163
disembark v 217
dishwasher 66
disinfectant solution 51
disposable 109
disposable camera 270
disposable diaper 30
disposable razor 73
dissertation 169
distance 310
distributor 203
district 315
dive 239
dive v 238
diver 238
divide v 165
divided by 165
divided highway 195
dividends 97
divider 173, 194
divorce 26
Diwali 27
DJ 179
Djibouti 317
do not bend v 98
dock 214, 216
dock v 217
doctor 45, 189
doctorate 169
documentary 178
dog 290
dog-sledding 247
doll 75
dollhouse 75
dolphin 290
dome 300
domestic flight 212
Dominica 314
Dominican Republic 314
dominoes 273
donkey 185
door 196, 198, 209
door chain 59
door knob 59
door knocker 59
door lock 200
doorbell 59
doormat 59
dormer 58
dorsal fin 294
dosage 109
double 151
double bass 256
double bassoon 257
double bed 71
double room 100
double-decker bus 196
doubles 230
dough 138
Dover sole 120
down 320
downhill skiing 247
download v 177
dragonfly 295
drain 61, 72, 299
drain cock 61
drainage 91
draining board 67
draw 223
draw v 162
drawer 66, 70, 172
drawing 275
dress 31, 34
dressage 243
dressed 159
dressed chicken 119
dressing 47, 158
dressing table 71
dribble v 223, 227
dried flowers 111
dried fruit 156
drill 50
drill v 79
drill bit 78
drill bits 80
drinking cup 75
drinking fountain 262
drinks 107, 144, 156
drip 53
drive v 195, 233
driver 196
driver's seat 196
driveshaft 202
drop anchor v 217
dropper 109, 167
drops 109
dropshot 230
drown v 239
drum 258
drum kit 258
drummer 258
dry 39, 41, 130, 145, 286, 321
dry v 76
dry-cleaner 115
dry dock 217
DTV converter box 269
duck 119, 185
duck egg 137
duckling 185
duffle bag 37
duffle coat 31
dugout 229
dumb bell 251
dumper truck 187
dunk v 227
duodenum 18
duplex 58
dusk 305
dust v 77
dustpan 77
duster 77
dust sheet 83
duty-free shop 213
DVD 269
DVD player 268
dyed 39
dynamo 207
E
eagle 292
ear 14
early
earring 36
Earth 280, 282
earthenware dish 69
earthquake 283
easel 174, 274
east 312
East Timor 319
Easter 27
easy 321
easy cook 130
eat v 64
eat-in 154
eating 75
eaves 58
éclair 140
eclipse 280
economics 169
economy class 211
Ecuador 315
eczema 44
edam 142
edge 246
editor 191
eel 294
egg 20
egg cup 65, 137
egg white 137
eggplant 125
eggs 137
Egypt 317
eight 308
eight hundred 308
eighteen 308
eighteenth 309
eighth 309
eightieth 309
eighty 308
ejaculatory duct 21
El Salvador 314
elbow 13
electric blanket 71
electric blood pressure monitor 45
electric car 199
electric drill 78
electric guitar 258
electric meter 60
electric razor 73
electric shock 46
electric train 208
electrical goods 105, 107
electrician 188
electricity 60
elephant 291
elevator 59, 100, 104
eleven 308
eleventh 309
elm 296
email 98, 177
email account 177
email address 177
embarrassed 25
embossed paper 83
embroidery 277
embryo 52
emerald 288
emergency 46

- emergency exit 210
 emergency lever 209
 emergency phone 195
 emergency room 48
 emergency services 94
 emigrate *v* 26
 emotions 25
 employee 24
 employer 24
 empty 321
 enamel 50
 encore 255
 encyclopedia 163
 end 321
 end zone 220
 endive 123
 endline 226
 endocrine 19
 endocrinology 49
 energy-saving bulb (eco bulb) 60
 engaged couple 24
 engine 202, 204, 208, 210
 engine room 214
 engineering 169
 English breakfast 157
 English mustard 135
 engraving 275
 enlarge *v* 172
 enlargement 271
 ENT (otolaryngology) 49
 entrance 59
 entrée 153
 envelope 98, 173
 environment 280
 epidural 52
 epiglottis 19
 epilepsy 44
 episiotomy 52
 equals 165
 equation 165
 equator 283
 equipment 233, 238
 equipment 165
 Equatorial Guinea 317
 equity 97
 eraser 163
 Eritrea 317
 erupt *v* 283
 escalator 104
 esophagus 19
 espresso 148
 essay 163
 essential oils 55
 estate 199
 Estonia 316
 estuary 285
 Ethiopia 317
 eucalyptus 296
 Europe 316
 evening 305
 evening dress 34
 evening menu 152
- events 243, 247
 evergreen 86
 evidence 181
 excavator 187
 excess baggage 212
 exchange rate 97
 excited 25
 excuse me 322
 executive 174
 exercise bike 250
 exercises 251
 exfoliate *v* 41
 exhaust pipe 203, 204
 exhibit *v* 261
 exhibition 261
 exit 210
 exit ramp 194
 exosphere 286
 expanding file 173
 expectant 52
 experiment 166
 expiration date 109
 exposure 271
 express train 209
 extend *v* 251
 extension 58
 extension cord 78
 exterior 198
 external hard drive 176
 extra time 223
 extraction 50
 extractor 66
 eye 14, 51, 244, 276
 eye shadow 40
 eye test 51
 eyebrow 14, 51
 eyebrow brush 40
 eyebrow pencil 40
 eyecup 269
 eyelash 14, 51
 eyelet 37
 eyelid 51
 eyeliner 40
 eyepiece 167
- F**
 fabric 277
 fabric conditioner 76
 face 14
 face cream 73
 face mask 225
 face pack 41
 face powder 40
 faceoff circle 224
 facial 41
 factory 299
 faint *v* 25, 44
 fair 41
 fairground 262
 fairway 232
 falcon 292
 Falkland Islands 315
 fall 237
 fall (autumn) 31, 307
- fall in love *v* 26
 fallopian tube 50
 family 22
 famous ruin 261
 fan 60, 202
 fan belt 203
 fans 258
 far 320
 fare 197, 209
 farm 182, 183, 184
 farmer 182, 189
 farmhouse 182
 farmland 182
 farmyard 182
 farsightedness 51
 fashion 277
 fast 321
 fast food 154
 fast-forward 269
 fastening 37
 fat 119, 321
 fat-free 137
 father 22
 father-in-law 23
 fault 230
 fava beans 122, 131
 fax 98, 172
 fax machine 172
 feather 293
 feature film 269
 February 306
 feed *v* 183
 feijoa 128
 female 12, 20
 feminine hygiene 108
 femur 17
 fence 85, 182, 243
 fencing 249
 feng shui 55
 fennel 122, 133
 fennel seeds 133
 fenugreek 132
 fern 86
 ferry 215, 216
 ferry terminal 216
 fertilization 20
 fertilize *v* 91
 fertilizer 91
 festivals 27
 fetus 52
 fever 44
 fiancé 24
 fiancée 24
 fiancer 127
 fibula 17
 field 182, 222, 225, 228, 234, 258, 266
 field *v* 225, 229
 field hockey 224
 fifteen 308
 fifteenth 309
 fifth 309
 fiftieth 309
 fifty 308
- fifty five thousand, five hundred 309
 fifty thousand 309
 fig 129
 fighter plane 211
 figure skating 247
 figurine 260
 Fiji 319
 filament 60
 file 81, 177
 filing cabinet 172
 fill *v* 82
 filler 83
 fillet 119, 121
 filleted 121
 filling 50, 140, 155
 film chamber 270
 film spool 271
 filter 270
 filter coffee 148
 filter paper 167
 fin 210
 finance 97
 financial advisor 97
 fingerprint 94
 finial 300
 finish line 234
 Finland 316
 fire 95
 fire alarm 95
 fire department 95
 fire engine 95
 fire escape 95
 fire extinguisher 95
 fire station 95
 firefighter 95, 189
 firelighter 266
 fireplace 63
 firm 124
 first 309
 first aid 47
 first-aid box 47
 first night 254
 fish 107, 120, 294
 fish and chips 155
 fish farm 183
 fisherman 189
 fishhook 244
 fishing 244, 245
 fishing boat 217
 fishing permit 245
 fishing port 217
 fishing rod 244
 fish-seller 114, 120, 188
 fist 15, 237
 fitness 250
 five 308
 five hundred 308
 flag 221, 232
 flageolet beans 131
 flakes 132
 flamingo 292
 flan 142
 flare 240
- flash 270
 flash gun 270
 flashlight 267
 flask 166
 flat 59, 256
 flat race 243
 flat tire 203, 207
 flat wood bit 80
 flatbread 139
 flatscreen TV 269
 flavored oil 134
 flax 184
 fleece 74
 flesh 124, 127, 129
 flex *v* 251
 flight attendant 190, 210
 flight number 213
 flint 288
 flipchart 174
 flip-flop 37
 flipper 239, 290
 float 238, 244
 float ball 61
 flock 183
 flood 287
 floor 58, 62, 71
 floor exercises 235
 floor plan 261
 florentine 141
 furet 122
 florist 110, 188
 floss *v* 50
 flours 138
 flower 297
 flowerbed 85, 90
 flowering plant 297
 flowering shrub 87
 flowers 110
 flu 44
 flute 139, 257
 fly 244, 295
 fly *v* 211
 fly-fishing 245
 flysheet 266
 foal 185
 focus *v* 271
 focusing knob 167
 fog 287
 foil 249
 folder 177
 foliage 110
 folk music 259
 follicle 20
 font 177
 food 118, 130, 149
 food hall 105
 food processor 66
 foot 12, 15, 310
 foot pedals (instrument) 257
 football 220
 footboard 71
 footpath 262

formal 34
 formal garden 84, 262
 fortieth 309
 forty 308
 forty minutes
 forward 222
 foul 222, 226
 foul ball 228
 foul line 229
 foundation 40
 fountain 85
 four 308
 four hundred 308
 four-door 200
 fourteen 308
 fourteenth 309
 fourth 309
 four-wheel drive 199
 fox 290
 foxglove 297
 foyer 59
 fraction 165
 fracture 46
 fragile 98
 fragranced 130
 frame 51, 62, 206, 230, 269
 France 316
 freckle 15
 free 321
 free kick 222
 free-range 118
 free weights 250
 freesia 110
 free-throw line 226
 freeway 194
 freeze 287
 freeze v 67
 freezer 67
 freight train 208
 freighter 215
 French bean 122
 French braid 39
 french fries 154
 French Guiana 315
 French horn 257
 French mustard 135
 French toast 157
 frequency 179
 fresh 121, 127, 130
 fresh cheese 136
 fresh fruit 157
 freshwater fishing 245
 fret 258
 fretsaw 81
 Friday 306
 fried 159
 fried chicken 155
 fried egg 157
 friend 24
 frieze 301
 frog 294
 from 320
 front crawl 239

front door 58
 front wheel 196
 frontage road 194, 216
 frontal 16
 frost 287
 froth 148
 frown 25
 frozen 121, 124
 frozen food 107
 frozen yogurt 137
 fruit 107, 126, 128
 fruit bread 139
 fruit cake 140
 fruit farm 183
 fruit juice 127, 156
 fruit tart 140
 fruit yogurt 157
 fry v 67
 frying pan 69
 fuel gauge 201
 fuel tank 204
 full 64, 266, 321
 full board 101
 full moon 280
 fumble 220
 funeral 26
 funnel 166, 214
 furniture store 115
 furrow 183
 fuse 60
 fuse box 60, 203
 fuselage 210

G

gable 300
 Gabon 317
 Galápagos Islands 315
 galaxy 280
 gale 286
 galley 214
 gallon 311
 gallop 243
 galvanized 79
 Gambia 317
 game 119, 230, 273
 game show 178
 games 272
 gangway 214
 garage 58, 199, 203
 garbage can 61, 67
 garbanzos 131
 garden 84
 garden center 115
 garden features 84
 garden pea 122
 garden plants 86
 garden styles 84
 garden tools 88
 gardener 188
 gardening 90
 gardening gloves 89
 gardens 261
 garland 111
 garlic 125, 132

garlic press 68
 garnet 288
 garter 35
 garter belt 35
 gas burner 61
 gas pump 199
 gas station 199
 gas tank 203
 gasket 61
 gasoline 199
 gate 85, 182, 247
 gate number 213
 gauze 47, 167
 gear lever 207
 gearbox 202, 204
 gears 206
 gearshift 201
 gel 38, 109
 gems 288
 generation 23
 generator 60
 genitals 12
 geography 162
 geometry 165
 Georgia 318
 gerbera 110
 Germany 316
 get a job v 26
 get married v 26
 get up v 71
 geyser 285
 Ghana 317
 giant slalom 247
 gift shop 114
 gill 294
 gin 145
 gin and tonic 151
 ginger 125, 133
 giraffe 291
 girder 186
 girl 23
 girlfriend 24
 girth 242
 glacier 284
 gladiolus 110
 gland 19
 glass 69, 152
 glass bottle 166
 glass stirrer 167
 glasses 51, 150
 glassware 64
 glaze v 139
 glider 211, 248
 gliding 248
 gloss 83, 271
 glove 224, 233, 236, 246
 gloves 36
 glue 275
 glue gun 78
 gneiss 288
 go to bed v 71
 go to sleep v 71
 goal 221, 223, 224

goal area 223
 goal line 220, 223, 224
 goalkeeper 222, 224
 goalpost 220, 222
 goat 185
 goat's cheese 142
 goat's milk 136
 goggles 238, 247
 going out 75
 gold 235, 289
 goldfish 294
 golf 232
 golf bag 233
 golf ball 233
 golf cart 232, 233
 golf clubs 233
 golf course 232
 golf shoe 233
 golfer 232
 gong 257
 good 321
 good afternoon 322
 good evening 322
 good morning 322
 good night 322
 goodbye 322
 goose 119, 293
 goose egg 137
 gooseberry 127
 gorge 284
 gorilla 291
 gothic 301
 grade 163
 graduate 169
 graduate v 26
 graduation ceremony 169
 graft v 91
 grains 130
 gram 310
 grandchildren 23
 granddaughter 22
 grandfather 22
 grandmother 22
 grandparents 23
 grandson 22
 granite 288
 grape juice 144
 grapefruit 126
 grapeseed oil 134
 graphite 289
 grass 86, 262
 grass bag 88
 grasshopper 295
 grassland 285
 grate v 67
 grated cheese 136
 grater 68
 gratin dish 69
 gravel 88
 gravity 280
 gray 39, 274
 graze 46
 greasy 39

Greece 316
 green 129, 232, 274
 green olive 143
 green onion 125
 green peas 131
 green salad 158
 green tea 149
 greenhouse 85
 Greenland 314
 Grenada 314
 grill pan 69
 grilled 159
 grip 78
 groceries 106
 grocery store 114
 groin 12
 groom 243
 ground 60, 132
 ground coffee 144
 ground cover 87
 ground floor 104
 ground meat 119
 ground sheet 267
 groundnut oil 135
 group therapy 55
 grout 83
 guard 236
 guard rail 195, 246
 Guatemala 314
 guava 128
 guest 64, 100
 guidebook 260
 guided tour 260
 guilty 181
 Guinea 317
 Guinea-Bissau 317
 guitarist 258
 gull 292
 gum 50
 gumdrop 113
 gun 94
 gutter 58, 299
 guy rope 266
 Guyana 315
 gym 101, 250
 gym machine 250
 gymnast 235
 gymnastics 235
 gynecologist 52
 gynecology 49
 gypsophila 110

H

hacksaw 81
 haddock 120
 hail 286
 hair 14, 38
 hair dye 40
 hairband 38
 hairdresser 38, 115, 188
 hair-dryer 38
 hairpin 38
 hairspray 38
 Haiti 314

- half an hour 304
 half-board 101
 half-time 223
 half-liter 311
 halibut fillets 120
 Halloween 27
 hallway 59
 halter 243
 halter neck 35
 ham 119, 143, 156
 hammer 80
 hammer v 79
 hammock 266
 hamper 263
 hamster 290
 hamstring 16
 hand 13, 15
 hand drill 81
 hand fork 89
 hand rail 59
 hand saw 89
 hand towel 73
 handbag 37
 handcuffs 94
 handicap 233
 handkerchief 36
 handle 36, 88, 106, 187, 200, 230
 handlebar 207
 handles 37
 handrail 196
 handsaw 80
 handset 99
 hang v 82
 hang-glider 248
 hang-gliding 248
 hanging basket 84
 hanging file 173
 happy 25
 harbor 217
 harbor master 217
 hard 129, 321
 hard candy 113
 hard cheese 136
 hard hat 186
 hard shoulder 194
 hardboard 79
 hardware 176
 hardware store 114
 hardwood 79
 haricot beans 131
 harness race 243
 harp 256
 harvest v 91, 183
 hat 36
 hatchback 199
 have a baby v 26
 Hawaii 314
 hay 184
 hayfever 44
 hazard 195
 hazard lights 201
 hazelnut 129
 hazelnut oil 134
 head 12, 19, 81, 230
 head v 222
 head injury 46
 headache 44
 headboard 70
 headlight 198, 205
 headphones 268
 headquarters 175
 headrest 200
 headsail 240
 health 44
 health food store 115
 heart 18, 119, 122, 273
 heart attack 44
 heater 60
 heater controls 201
 heather 297
 heating element 61
 heavy 321
 heavy metal 259
 hedge 85, 90, 182
 hedgehog 290
 heel 13, 15, 37
 height 165
 helicopter 211
 hello 322
 helmet 95, 204, 206, 220, 224, 228
 helpdesk 168
 hem 34
 hematite 289
 hemorrhage 46
 hen's egg 137
 herb 55, 86
 herb garden 84
 herbaceous border 35
 herbal remedies 108
 herbal tea 149
 herbalism 55
 herbicide 183
 herbs 133, 134
 herbs and spices 132
 herd 183
 hexagon 164
 high 321
 high chair 75
 high-definition 269
 high dive 239
 high-heeled shoe 37
 high jump 235
 high speed train 208
 highlights 39
 hiking 263
 hill 284
 Himalayas 313
 hip 12
 hippopotamus 291
 historic building 261
 history 162
 hit v 224
 hockey 224
 hockey stick 224
 hoe 88
 hold 215, 237
 hole 232
 hole in one 233
 hole punch 173
 holly 296
 home 58
 home delivery 154
 home entertainment 268
 home furnishings 105
 home plate 228
 homeopathy 55
 homework 163
 homogenized 137
 Honduras 314
 honeycomb 135
 honeymoon 26
 honeysuckle 297
 hood 31, 75, 198
 hoof 242, 291
 hook 187, 276
 hoop 226, 277
 horizontal bar 235
 hormone 20
 horn 201, 204, 291
 horror movie 255
 horse 185, 235, 242
 horse race 243
 horseback riding 242, 263
 horseradish 125
 horseshoe 242
 hose 89, 95
 hose reel 89
 hospital 48
 host 64
 hostess 64
 hot 124, 286, 321
 hot chocolate 144, 156
 hot dog 155
 hot-dog vendor 154
 hot drinks 144
 hot faucet 72
 hot-air balloon 211
 hotel 100, 264
 hot-water bottle 70
 hour 304
 hour hand 304
 house 58
 household products 107
 hovercraft 215
 hub 206
 hubcap 202
 hull 214, 240
 human resources 175
 humerus 17
 humid 286
 hummingbird 292
 hump 291
 hundred 308
 hundred and ten 308
 hundred thousand 308
 hundredth 309
 Hungary 316
 hungry 64
 hurdles 235
 hurricane 287
 husband 22
 husk 130
 hydrant 95
 hydrofoil 215
 hydrotherapy 55
 hypnotherapy 55
 hypoallergenic 41
 hypotenuse 164
I
 ice 120, 287
 ice and lemon 151
 ice bucket 150
 ice climbing 247
 ice cream 149
 ice cube 151
 ice hockey 224
 ice hockey player 224
 ice hockey rink 224
 ice maker 67
 ice cream 137
 iced coffee 148
 iced tea 149
 ice-skate 224
 ice-skating 247
 Iceland 316
 icicle 287
 icing 141
 icon 177
 identity tag 53
 igneous 288
 ignition 200
 iguana 293
 illness 44
 immigration 212
 impotent 20
 in 320
 in brine 143
 in front of 320
 in oil 143
 in sauce 159
 in syrup 159
 inbox 177
 inch 310
 incisor 50
 incubator 53
 index finger 15
 India 318
 Indian Ocean 312
 indigo 274
 Indonesia 319
 induce labor v 53
 industrial park 299
 infection 44
 infertile 20
 infield 228
 inflatable dinghy 215
 information 261
 information screen 213
 in-goal area 221
 inhaler 44, 109
 injection 48
 injury 46
 ink 275
 ink pad 173
 inlet 61
 inline skating 249
 inner core 282
 inner tube 207
 inning 228
 innocent 181
 inoculation 45
 insect repellent 108, 267
 inside 320
 insomnia 71
 inspector 94
 install v 177
 instant camera 270
 instep 15
 instructions 109
 instruments 256, 258
 insulating tape 81
 insulation 61
 insulin 109
 insurance 203
 intensive care unit 48
 interchange 194
 intercom 59
 intercostal 16
 intercourse 20
 interest rate 96
 interior 200
 internal systems 60
 international flight 212
 internet 177
 intersection 298
 interval 254
 interviewer 179
 into 320
 in-tray 172
 invertebrates 295
 investigation 94
 investment 97
 ionosphere 286
 iPod 268
 iPad 176
 Iran 318
 Iraq 318
 Ireland 316
 iris 51, 110
 iron 76, 109, 233, 289
 iron v 76
 ironing board 76
 island 282
 Israel 318
 Italy 316
 itinerary 260
 IUD 21
 Ivory Coast 317
J
 jack 203, 273
 jacket 32, 34
 jackhammer 187
 jade 288
 jam 134, 156
 Jamaica 314

- jar 134, 311
javelin 234
jaw 14, 17
jazz 259
jeans 31, 33
jelly bean 113
jellyfish 295
Jerusalem artichoke 125
jet 288
jet-skiing 241
jetty 217
jeweler 188
jewelry store 114
jewelry 36
jewelry box 36
jewelry-making 275
jigsaw 78
jigsaw puzzle 273
jodhpurs 242
jog in place 251
jogging 251, 263
jogging suit 31, 32
joint 17, 119
joker 273
Jordan 318
journal 168
journalist 190
judge 180
judo 236
jug 65
juices and milkshakes 149
juicy 127
July 306
jumbo shrimp 121
jump 237, 243
jump v 227
jump ball 226
jumping rope 251
June 306
Jupiter 280
jury 180
jury box 180
- K**
kale 123
kangaroo 291
karate 236
Karlíngrad 316
kayak 241
Kazakhstan 318
kebab 155, 158
keel 214
keep net 244
kendo 236
Kenya 317
kernel 122, 129, 130
ketchup 135, 154
kettle 66
kettledrum 257
key 59, 80, 176, 207
keyboard 176, 258
keypad 97, 99
kick 237, 239
- kick v 221, 223
kickboxing 236
kickstand 207
kid 185
kidney 18, 119
kilogram 310
kilometer 310
king 272, 273
kippers 157
kitchen 66, 152
kitchen knife 68
kitchenware 68, 105
kitten 290
kiwifruit 128
knead v 138
knee 12
knee pad 205
knee support 227
kneecap 17
knee-length 34
knife 65, 80
knife sharpener 68, 118
knight 272
knitting 277
knitting needle 277
knock out 237
knuckle 15
koala 291
kohlrabi 123
koi carp 294
kumquat 126
kung fu 236
Kuwait 318
Kyrgyzstan 318
- L**
labels 89
labia 20
laboratory 166
lace 35, 37
lace bobbin 277
lace-making 277
lace-up 37
lacrosse 249
lactose 137
ladder 95, 186
ladle 68
lady fingers 141
ladybug 295
lake 285
lamb 118, 185
lamp 62, 207, 217
land 282
land v 211
landing 59
landing gear 210
landing net 244
landlord 58
landscape 271, 284
landscape v 91
lane 234, 238
languages 162
Laos 318
lapel 32
- laptop 175
larch 296
large 321
large intestine 18
larynx 19
last week 307
lat 16
late 305
later 304
latex paint 83
latitude 283
Latvia 316
laugh v 25
launch 281
launch pad 281
laundromat 115
laundry 76
laundry basket 76
laundry service 101
lava 283
law 169, 180
lawn 85, 90
lawn rake 88
lawnmower 88, 90
lawyer 180, 190
lawyer's office 180
laxative 109
lead singer 258
leaded 199
leaf 122, 296
league 223
lean meat 118
learn v 163
leather shoes 32
leathers 205
Lebanon 318
lecture hall 169
leek 125
left 260
left field 228
left-hand drive 201
leg 12, 119
leg pad 225
leg press 251
legal advice 180
legal department 175
leggings 31
legumes 130
leisure 258, 254, 264
lemon 126
lemon curd 134
lemon grass 133
lemon sole 120
lemonade 144
length 165, 310
lens 270
lens (eye) 51
lens (glasses) 51
lens cap 270
lens case 51
Lesotho 317
lesson 163
let! 231
letter 98
- letter slot 58, 99
letterhead 173
lettuce 123
level 80, 187
lever 61, 150
Liberia 317
librarian 168, 190
library 168, 299
library card 168
Libya 317
license plate 198
liquor store 115
licorice 113
lid 61, 66
Liechtenstein 316
life events 26
life jacket 240
life preserver 240
life raft 240
lifeboat 214
lifeguard 239, 265
lifeguard tower 265
ligament 17
light 178, 321
light a fire v 266
light aircraft 211
light bulb 60
lighter 112
lighthouse 217
lighting 105
lightmeter 270
lightning 287
lights 94
lights switch 201
lily 110
lime 126, 296
limestone 288
limousine 199
line 244
line judge 220
line of play 233
linen 105, 277
linen basket 76
lines 165
linesman 223, 230
lingerie 35, 105
lining 32
lining paper 83
link 36
lintel 186
lion 291
lip 14
lip brush 40
lip gloss 40
lip liner 40
lipstick 40
liqueur 145
liquid 77
liquid dispenser 311
liquid measure 311
liter 311
literature 162, 169
Lithuania 316
little finger 15
- little toe 15
live 60, 178
live rail 209
liver 18, 118
livestock 183, 185
living room 62
lizard 293
load v 76
load line 214
loaf 139
loan 96, 168
lob 230
lobby 100, 255
lobster 121, 295
lock 59, 207
lockers 239
log on v 177
loganberry 127
logo 31
loin 121
lollipop 113
long 32
long jump 235
long wave 179
long-grain 130
long-handled shears 88
longitude 283
loofah 73
loom 277
loose tea 144
lose v 273
loser 273
lotion 109
lottery tickets 112
love 230
low 321
luge 247
luggage 100, 198, 213
luggage department 104
luggage hold 196
luggage rack 209
lumbar vertebrae 17
lunar module 281
lunch 64
lunch menu 152
lung 18
lunges 251
lining 32
lining paper 83
link 36
lintel 186
lion 291
lip 14
lip brush 40
lip gloss 40
lip liner 40
lipstick 40
liqueur 145
liquid 77
liquid dispenser 311
liquid measure 311
liter 311
literature 162, 169
Lithuania 316
little finger 15

- magazines 107
 magma 283
 magnesium 109
 magnet 167
 maid service 101
 mail carrier 98, 190
 mailbag 98, 190
 mailbox 99
 mainsail 240
 make a will *v* 26
 make friends *v* 26
 make the bed *v* 71
 makeup 40
 making bread 138
 malachite 288
 Malawi 317
 Malaysia 318
 Maldives 318
 male 12, 21
 Mali 317
 mallet 78, 275
 malt vinegar 135
 Malta 316
 malted drink 144
 mammals 290
 man 23
 manager 24, 174
 manchego 142
 mane 242, 291
 mango 128
 mangosteen 128
 manhole 299
 manicure 41
 mantle 282
 manual 200
 map 261
 maple 296
 maple syrup 134
 maracas 257
 marathon 234
 marble 288
 March 306
 margarine 137
 marina 217
 marinated 143, 159
 marine fishing 245
 marjoram 133
 mark *v* 227
 market 115
 marketing department 175
 marmalade 134, 156
 marrow 124
 Mars 280
 marshmallow 113
 martial arts 237
 martini 151
 marzipan 141
 mascara 40
 mashed 159
 masher 68
 mask 189, 228, 236, 239, 249
 masking tape 83
 masonry bit 80
 massage 54
 mast 240
 masters 169
 mat 54, 83, 235, 271
 match 230
 material 276
 materials 79, 187
 maternity 49
 maternity ward 48
 math 162, 164
 mattress 70, 74
 Mauritiana 317
 Mauritius 317
 May 306
 maybe 322
 mayonnaise 135
 MDF 79
 meadow 285
 meal 64
 measles 44
 measure 150, 151
 measure *v* 310
 measurements 165
 measuring cup 69, 311
 measuring spoon 109
 meat 119
 meat and poultry 106
 meat tenderizer 68
 meatballs 158
 meathook 118
 mechanic 188, 203
 mechanics 202
 medals 235
 media 178
 medical examination 45
 medication 109
 medicine 109, 169
 medicine cabinet 72
 meditation 54
 Mediterranean Sea 313
 medium wave 179
 meeting 174
 meeting room 174
 melody 259
 melon 127
 memory 176
 memory stick 176
 men's clothing 32
 menswear 105
 menstruation 20
 menu 148, 153, 154
 menu bar 177
 mercury 289
 Mercury 280
 meringue 140
 mesosphere 286
 messages 100
 metacarpal 17
 metal 79
 metal bit 80
 metals 289
 metamorphic 288
 metatarsal 17
 meteor 280
 meter 310
 Mexico 314
 mica 289
 microphone 179, 258
 microscope 167
 microwave oven 66
 midday 305
 middle finger 15
 midnight
 midwife 53
 migraine 44
 mile 310
 milk 136, 156
 milk *v* 183
 milk carton 136
 milk chocolate 113
 milkshake 137
 millennium 307
 millet 130
 milligram 310
 milliliter 311
 millimeter 310
 mineral 144
 mineral spirits 83
 minerals 289
 mini bar 101
 minibus 197
 minivan 199
 mini-dress 34
 mint 113, 133
 mint tea 149
 minus 165
 minute 304
 minute hand 304
 minutes 174
 mirror 40, 71, 167
 miscarriage 52
 Miss 23
 missile 211
 mist 287
 miter block 81
 mitt 228
 mittens 30
 mix *v* 67, 138
 mixing bowl 66, 69
 mixing desk 179
 moat 300
 mobile 74
 model 169, 190
 model-making 275
 modeling tool 275
 moisturizer 41
 molar 50
 Moldova 316
 mole 14
 Monaco 316
 Monday 306
 money 97
 money order 98
 Mongolia 318
 monitor 172
 monitor 53
 monkey 291
 monkfish 120
 monopoly 272
 monorail 208
 monsoon 287
 month 306
 monthly 307
 monument 261
 Moon 280
 moonstone 288
 moor *v* 217
 mooring 217
 mop 77
 morning 305
 Morocco 317
 mortar 68, 167, 187
 mortgage 96
 mosque 300
 mosquito 295
 mosquito net 267
 moth 295
 mother 22
 mother-in-law 23
 motocross 249
 motor 88
 motor racing 249
 motorcycle 204
 motorcycle racing 249
 molding 63
 motor 88
 mountain 284
 mountain bike 206
 mountain range 282
 mouse 176, 290
 mousse 141
 mouth 14
 mouth guard 237
 mouthwash 72
 move 273
 movie 260, 271
 movie set 179
 movie theater 255, 299
 mow *v* 90
 Mozambique 317
 mozzarella 142
 Mr. 23
 Mrs. 23
 mudguard 205
 muffin 140
 muffin pan 69
 muffler 203, 204
 mug 65
 mulch *v* 91
 multigrain bread 139
 multiply *v* 165
 multivitamin tablets 109
 mumps 44
 mung beans 131
 muscles 16
 museum 261
 mushroom 125
 music 162
 music school 169
 musical 255
 musical score 255
 musical styles 259
 musician 191
 mussel 121, 295
 mustard 155
 mustard seed 131
 Myanmar 318
N
 naan bread 139
 nail 15, 80
 nail clippers 41
 nail file 41
 nail polish 41
 nail polish remover 41
 nail scissors 41
 Namibia 317
 nape 13
 napkin 65
 napkin ring 65
 narrow 321
 nation 315
 national park 261
 natural 256
 natural fiber 31
 naturopathy 55
 nausea 44
 navel 12
 navigate *v* 240
 near 320
 nearsightedness 51
 nebula 280
 neck 12, 258
 neck brace 46
 necklace 36
 nectarine 126
 needle 109, 276
 needle plate 276
 needlenose pliers 80
 needlepoint 277
 negative 271
 negative electrode 167
 neighbor 24
 neoclassical 301
 Nepal 318
 nephew 23
 Neptune 280
 nerve 19, 50
 nervous 19, 25
 net 217, 222, 226, 227, 231
 net *v* 245
 net curtain 63
 Netherlands 316
 nettle 297
 network 176
 neurology 49
 neutral 60

- neutral zone 224
 new 321
 new moon 280
 new potato 124
 New Year 27
 New Zealand 319
 newborn baby 53
 news 178
 newscaster 179, 191
 newspaper 112
 newsstand 112
 next week 306
 nib 163
 Nicaragua 314
 nickel 289
 niece 23
 Niger 317
 Nigeria 317
 night 305
 nightgown 35
 nightie 31
 nightwear 31
 nightstand 70
 nightstick 94
 nine 308
 nine hundred 308
 nineteen 308
 nineteen hundred 307
 nineteen hundred and one 307
 nineteen ten 307
 nineteenth 309
 ninetieth 309
 ninety 308
 ninth 309
 nipple 12
 no 322
 no entry 195
 no right turn 195
 no stopping 195
 nonstick 69
 noodles 158
 normal 39
 north 312
 North and Central America 314
 North Korea 318
 North Pole 283
 North Sea 312
 Northern Hemisphere 283
 Norway 316
 nose 14, 210
 nose clip 238
 noseband 242
 nosebleed 44
 nosewheel 210
 nostril 14
 notation 256
 note 97, 256
 notecard 173
 notepad 173
 notebook 163, 172
 notes 191
 notice board 173
 notions 105
 nougat 113
 November 306
 now 304
 nozzle 89
 number 226
 numbers 308
 numerator 165
 nurse 45, 48, 52, 189
 nursery 74
 nursing 53
 nursing bra 53
 nut 80
 nutmeg 132
 nuts 151
 nuts and dried fruit 129
 nylon 277
- O**
 oak 296
 oar 241
 oatmeal 156
 oats 130
 objective lens 167
 oboe 257
 obsidian 288
 obstetrician 52
 occupations 188, 190
 occupied 321
 ocean 282
 ocean liner 215
 octagon 164
 October 306
 octopus 121, 295
 odometer 201
 offal 118
 offers 106
 office 24, 172, 174
 office building 298
 office equipment 172
 office supplies 173
 off-piste 247
 off-side 223
 oil 142, 199
 oil paints 274
 oil tank 204
 oil tanker 215
 oils 134
 oily 41
 ointment 47, 109
 okra 122
 old 321
 olive oil 134
 olives 151
 Oman 318
 omelet 158
 on time 305
 on top of 320
 oncology 49
 one 308
 one billion 309
 one million 309
 one thousand 309
 one-way 194
 one-way system 298
 onion 124
 on-line 177
 onto 320
 onyx 289
 opal 288
 open 260, 321
 open sandwich 155
 open-top 260
 opera 255
 operating room 48
 operation 48
 operator 99
 ophthalmology 49
 opponent 236
 opposite 320
 optic 150
 optic nerve 51
 optician 51, 189
 orange 126, 274
 orange juice 148
 orangeade 144
 orbit 280
 orchestra 254, 256
 orchestra pit 254
 orchid 111
 order v 153
 oregano 133
 organic 91, 118, 122
 organic waste 61
 organizer 175
 origami 275
 ornamental 87
 orthopedics 49
 osteopathy 54
 ostrich 292
 otter 290
 ounce 310
 out 225, 228, 320
 out of bounds 226
 out of focus 271
 outboard motor 215
 outbuilding 182
 outdoor activities 262
 outer core 282
 outfield 229
 outlet 61
 outpatient 48
 outside 320
 out-tray 172
 oval 164
 ovary 20
 oven 66
 oven mitt 69
 ovenproof 69
 over 320
 over par 233
 overalls 30, 82
 overdraft 96
 overexposed 271
 overflow pipe 61
 overhead bin 210
 overhead projector 163
 overpass 194
 overture 256
 ovulation 20, 52
 owl 292
 oyster 121
 ozone layer 286
- P**
 Pacific Ocean 312
 pack 311
 pack of cigarettes 112
 package 99, 311
 pad 224
 paddle 241
 paddock 242
 pads 53, 220
 painkiller 109
 painkillers 47
 pail 77, 82, 265
 paint 83
 paint v 83
 paint can 83
 paint tray 83
 painter 191
 painting 62, 261, 274
 paints 274
 pajamas 33
 pak-choi 123
 Pakistan 318
 palate 19
 palette 274
 pallet 186
 palm 15, 86, 296
 palm hearts 122
 pan 310
 pan-fried 159
 Panama 314
 pancreas 18
 panda 291
 panties 35
 pants 32, 34
 panty liner 108
 papaya 128
 paper clip 173
 paper napkin 154
 paper tray 172
 papier-maché 275
 paprika 132
 Papua New Guinea 319
 par 233
 parachute 248
 parachuting 248
 paragliding 248
 Paraguay 315
 parallel 165
 parallel bars 235
 parallelogram 164
 paramedic 94
 parents 23
 park 262
 park v 195
 parka 31, 33
 parking brake 203
 parking meter 195
 parking lot 298
 parmesan 142
 parole 181
 parrot 293
 parsley 133
 parsnip 125
 partner 23
 pass 226
 pass v 195, 220, 223
 passcode 99
 passenger 216
 passenger port 216
 passion fruit 128
 Passover 27
 passport 213
 passport control 213
 pasta 158
 pastels 274
 pasteurized 137
 pasting brush 82
 pasting table 82
 pastry 140, 149
 pastry brush 69
 pasture 182
 patch 207
 patchwork 277
 pâté 142, 156
 path 58, 85
 pathology 49
 patient 45
 patio garden 85
 pattern 276
 pause 269
 paving 85
 pawn 272
 pay v 153
 pay-per-view channel 269
 payphone 99
 payment 96
 payroll 175
 peach 126, 128
 peacock 293
 peanut 129
 peanut butter 135
 peanuts 151
 pear 127
 peas 131
 pecan 129
 pectoral 16
 pectoral fin 294
 pedal 61, 206
 pedal v 207
 pedestrian zone 299
 pediatrics 49
 pedicure 41
 pediment 301
 peel v 67
 peeled shrimp 120
 pelican 292
 pelvis 17
 pen 163, 185
 pen holder 172
 pen pal 24

- penalty 222
penalty area 223
pencil 163, 275
pencil case 163
pencil sharpener 163
pendant 36
penguin 292
peninsula 282
penis 21
pentagon 164
peony 111
people 12, 16
pepper 64, 124, 152
peppercorn 132
pepperoni 142
percentage 165
percussion 257
perennial 86
perfume 41, 105
pergola 84
periodical 168
perm 39
perpendicular 165
persimmon 128
personal best 234
personal organizer 173, 175
personal trainer 250
Peru 315
pesticide 89, 183
pestle 68, 167
pet food 107
pet store 115
petal 297
petri dish 166
pharmacist 108, 189
pharmacy 108
pharynx 19
pheasant 119, 293
Phillips screwdriver 81
philosophy 169
Philippines 319
photo album 271
photo finish 234
photographer 191
photograph 271
photograph v 271
photography 270
phyllo pastry 140
physical education 162
physics 162, 169
physiotherapy 49
piano 256
piccolo 257
pick v 91
pick-and-mix 113
pickax 187
pickled 159
pickup 258
picnic 263
picnic bench 266
picture frame 271
pie 158
pie pan 69
piece 272
pier 217
pies 143
pig 185
pig farm 183
pigeon 292
pigeonhole 100
piglet 185
pigsty 185
pigtails 39
Pilates 251
pill 21, 109
pillar 300
pillion 204
pillow 70
pillowcase 71
pilot 190, 211
pin 60, 237, 249, 276
PIN 96
pincushion 276
pine 296
pine nut 129
pineapple 128
pineapple juice 149
pink 274
pint 311
pinto beans 131
pipe 112, 202
pipe cutter 81
pipette 167
piping bag 69
pistachio 129
pita bread 139
pitch v 229
pitch a tent v 266
pitcher 151, 229
pitcher's mound 228
pitches available 266
pith 126
pizza 154
pizzeria 154
place mat 64
place setting 65
placenta 52
plain 285
plane 81
plane v 79
planet 280, 282
plant v 183
plant pot 89
plants 86, 296
plaque 50
plaster v 82
plastic bag 122
plastic pants 30
plastic surgery 49
plate 283
plateau 284
platform 208
platform number 208
platinum 289
play 254, 269
play v 229, 273
player 221, 231, 273
playground 263
playhouse 75
playing 75
playpen 75
plea 180
please 322
plow v 183
plug 60, 72
plum 126
plumb line 82
plumber 188
plumbing 61
plunger 81
plus 165
Pluto 280
plywood 79
poach v 67
poached 159
pocket 32
pod 122
podium 235, 256
point 273
poisoning 46
poker 273
Poland 316
polar bear 291
Polaroid camera 270
pole 245, 282
pole vault 234
police 94
police car 94
police officer 94, 189
police station 94
polish 77
polish v 77
politics 169
polo 243
polyester 277
pomegranate 128
pommel 242
pommel horse 235
pond 85
pontail 39
pool 249
pop 259
popcorn 255
poplar 296
popper 30
poppy 297
poppy seeds 138
porch 58
porch light 58
pore 15
pork 118
pork 145, 176, 214, 216
porter 100
portfolio 97
porthole 214
portion 64
portrait 271
Portugal 316
positive electrode 167
post office 98
postage 98
postal worker 98
postcard 112
poster 255
poster paint 274
postgraduate 169
postmark 98
pot v 91
potato 124
potpourri 111
potted plant 87, 110
potter's wheel 275
pottery 275
potty 74
pouch 291
poultry 119
poultry farm 183
pound 310
pour v 67
powder 77, 109
powder puff 40
powdered milk 137
pour 60
power cord 176
power outage 60
practice swing 233
pam 75
praying mantis 295
pregnancy 52
pregnancy test 52
pregnant 52
premature 52
premolar 50
prenatal 52
prerecorded 178
prescription 45
present 27
presentation 174
presenter 178
preservative 83
preserved fruit 134
press 178
presser foot 276
pressure valve 61
price 152, 199
price list 154
prickly pear 128
primer 83
primrose 297
principal 163
principality 315
print 271
print v 172
printer 172, 176
printing 275
prison 181
prison guard 181
private bathroom 100
private jet 211
private room 48
probe 50
problems 271
processed grains 130
procession 27
processor 176
produce stand 114, 188
producer 254
professor 169
program 176
program 254, 269
programming 178
propagate v 91
propeller 211, 214
proposal 174
prosciutto 143
prosecution 180
prostate 21
protractor 165
proud 25
prove v 139
province 315
prow 215
prune 129
prune v 91
pruners 89
psychiatry 49
psychotherapy 55
public address system 209
puck 224
pudding rice 130
Puerto Rico 314
puff pastry 140
pull up v 251
pulp 127
pulse 47
pumice 288
pumice stone 73
pump 37, 207
pumpkin 125
pumpkin seed 131
punch 237
punching bag 237
pup 290
pupil 51, 162
puppy 290
purple 274
pushup 251
purse 37
putt v 233
putter 233
pyramid 164

Q

- Qatar 318
quadriceps 16
quail 119
quail egg 137
quart 311
quarter of an hour 304
quarterdeck 214
quartz 289
queen 272, 273
question 163
question v 163
quiche pan 69

quilt 71
 quilting 277
 quince 128
 quinoa 130
 quiver 249

R

rabbit 118, 290
 raccoon 290
 race 234
 race-car driver 249
 racecourse 243
 racehorse 243
 racing bike 205, 206
 racing dive 239
 rack 166
 racket 230
 racket games 231
 racquetball 231
 radar 214, 281
 radiator 60, 202
 radiccchio 123
 radio 179, 268
 radio antenna 214
 radio station 179
 radiology 49
 radish 124
 radius 17, 164
 rafter 186
 rafting 241
 rail 208
 rail network 209
 rain 287
 rain gear 245, 267
 rainbow 287
 rainbow trout 120
 raincoat 31, 32
 rainforest 285
 raisin 129
 rake 88
 rake v 90
 rally 230
 rally driving 249
 RAM 176
 Ramadan 26
 ramekin 69
 range 67
 rap 259
 rapeseed 184
 rapids 240, 284
 rappeling 248
 rash 44
 raspberry 127
 raspberry jam 134
 rat 290
 rattle 74
 raw 124, 129
 ray 294
 razor blade 73
 razorshell clam 121
 read v 162
 reading light 210
 reading list 168
 reading room 168

reamer 80
 rear light 207
 rear wheel 197
 rearview mirror 198
 receipt 152
 receive v 177
 receiver 99
 reception 100
 receptionist 100, 190
 record 234, 269
 record player 268
 record store 115
 recording studio 179
 rectangle 164
 rectum 21
 recycling bin 61
 red 145, 274
 red card 223
 red-eye 271
 red kidney beans 131
 red lentils 131
 red meat 118
 red mullet 120
 Red Sea 313
 reduce v 172
 reduced-fat milk 136
 reel 244
 reel in v 245
 referee 222, 226
 referral 49
 reflector 50, 204, 207
 reflector strap 205
 reflexology 54
 refrigerator 67
 reggae 259
 region 315
 register 100
 registered mail 98
 regulator 239
 reheat v 154
 reiki 55
 reins 242
 relationships 24
 relatives 23
 relaxation 55
 relay race 235
 release v 245
 remote control 269
 Renaissance 301
 renew v 168
 rent 58
 rent v 58
 repair kit 207
 reporter 179
 reproduction 20
 reproductive 19
 reproductive organs 20
 reptiles 293
 research 169
 reserve v 168
 residence hall 168
 respiratory 19
 rest 256

restaurant 101, 152
 result 49
 resurfacing 187
 resuscitation 47
 retina 51
 retire v 26
 return 231
 return address 98
 return date 168
 rewind 269
 rhinoceros 291
 rhombus 164
 rhubarb 127
 rhythmic gymnastics 235
 rib 17, 119
 rib cage 17
 ribbon 27
 ribbon 39, 111, 141, 235
 ribs 155
 rice 130, 158, 184
 rice pudding 140
 rider 242
 riding boot 242
 riding crop 242
 riding hat 242
 rigging 215, 240
 right 260
 right field 229
 right-hand drive 201
 rim 206
 rind 119, 127, 136, 142
 ring 36
 ring binder 173
 ring finger 15
 ring ties 89
 rings 235
 rinse v 38, 76
 ripe 129
 rise v 139
 river 284
 road bike 206
 road markings 194
 road signs 195
 roads 194
 road work 187, 195
 roast 158
 roast v 67
 roasted 129
 roasting pan 69
 robe 35, 38, 169
 rock climbing 248
 rock concert 258
 rock garden 84
 rocket 123
 rocks 284, 288
 Rocky Mountains 312
 rococo 301
 rodeo 243
 roll 139, 311
 roll v 67
 roller 83, 187
 roller coaster 262
 roller shade 63
 rollerblading 263

rolling pin 69
 romance 255
 Romania 316
 romper 30
 roof 58, 203
 roof garden 84
 roof tile 187
 roof rack 198
 rook 272
 room 58
 room key 100
 room number 100
 room service 101
 rooms 100
 rooster 185
 root 50, 124, 296
 rope 248
 rose 89, 110, 145
 rosé 145
 rosemary 133
 rotor blade 211
 rotten 127
 rough 232
 round 237
 round neck 33
 roundabout 195
 route number 196
 router 78
 row 210, 254
 row v 241
 rower 241
 rowboat 214
 rowing machine 250
 rubber band 173
 rubber boots 89
 rubber ring 265
 rubber stamp 173
 ruber 288
 ruck 221
 rudder 210, 241
 rug 63
 rugby 221
 ruler 163, 165
 rum 145
 rum and coke 151
 rump steak 119
 run 228
 run v 228
 running shoe 37
 runway 212
 rush 86
 rush hour 209
 Russian Federation 318
 rutabaga 125
 Rwanda 317
 rye bread 138

S

sad 25
 saddle 206, 242
 safari park 262
 safe 228
 safety 75, 240
 safety goggles 81, 167

safety pin 47
 saffron 132
 sage 133
 Sahara Desert 313
 sail 241
 sailboat 215
 sailing 240
 sailor 189
 salad 149
 salamander 294
 salami 142
 salary 175
 sales clerk 104, 188
 sales department 175
 salmon 120
 salt 64, 152
 salted 121, 129, 137, 143
 San Marino 316
 sand 85, 264
 sand v 82
 sandal 37
 sandals 31
 sandbox 263
 sandcastle 265
 sander 78
 sandpaper 81, 83
 sandstone 288
 sandwich 155
 sandwich counter 143
 sanitary napkin 108
 São Tomé and Príncipe 317
 sapphire 288
 sardine 120
 Sardinia 316
 satellite 281
 satellite dish 269
 satellite navigation 201
 satnav 195
 satsuma 126
 Saturday 306
 Saturn 280
 sauce 134, 143, 155
 saucepan 69
 Saudi Arabia 318
 sauna 250
 sausage 155, 157
 sausages 118
 sauté v 67
 save v 177, 223
 savings 96
 savings account 97
 savory 155
 saw v 79
 saxophone 257
 scaffolding 186
 scale 121, 256, 294
 scales 45, 53, 69, 98, 118, 166, 212, 293, 310
 scallop 121
 scalp 39
 scalpel 167

- scan 48, 52
 scanner 106, 176
 scarecrow 184
 scared 25
 scarf 31, 36
 schedule 197, 209, 261
 schist 288
 scholarship 169
 school 162, 299
 school bus 196
 schoolbag 162
 schoolboy 162
 schoolgirl 162
 schools 169
 science 162, 166
 science fiction movie
 255
 scientist 190
 scissors 38, 47, 82, 276
 scoop 68, 149
 scooter 205
 score 220, 256, 273
 score a goal v 223
 scoreboard 225
 scorpion 295
 scotch and water 151
 scrabble 272
 scrambled eggs 157
 scrape v 77
 scraper 82
 screen 59, 97, 176, 255,
 269
 screw 80
 screwdriver 80, 151
 screwdriver bits 80
 script 254
 scrollbar 177
 scrotum 21
 scrub v 77
 scrum 221
 scuba diving 239
 sculpting 275
 sculptor 191
 sea 264, 282
 sea bass 120
 sea bream 120
 sea horse 294
 sea lion 290
 sea plane 211
 seafood 121
 seal 290
 sealant 83
 sealed jar 135
 seam 34
 seamstress 191
 search v 177
 seasonal 129
 seasons 306
 seat 61, 204, 209, 210,
 242, 254
 seat back 210
 seat belt 198, 211
 seat post 206
 seating 254
 second 304, 309
 second floor 104
 second-hand 304
 second-hand store 115
 section 282
 security 212
 security bit 80
 security guard 189
 sedan 199
 sedative 109
 sedimentary 288
 seed 122, 127, 128, 130
 seed tray 89
 seeded bread 139
 seedless 127
 seedling 91
 seeds 88, 131
 seasaw 263
 segment 126
 self-defense 237
 self-rising flour 139
 self-tanning cream 41
 semi-hard cheese 136
 seminal vesicle 21
 semi-soft cheese 136
 semisweet chocolate
 113
 semolina 130
 send v 177
 send off 223
 Senegal 317
 sensitive 41
 sentence 181
 September 306
 series 179
 serve 231
 serve v 64, 231
 server 176
 service included 152
 service line 230
 service not included 152
 service provider 177
 service vehicle 212
 serving spoon 68
 sesame seed 131
 sesame oil 134
 set 178, 230, 254
 set v 38
 set honey 134
 set sail v 217
 set the alarm v 71
 set the table v 64
 seven 308
 seven hundred 308
 seventeen 308
 seventeenth 309
 seventh 309
 seventieth 309
 seventy 308
 sew v 277
 sewing basket 276
 sewing machine 276
 sexually transmitted
 disease 20
 shade 41
 shade plant 87
 shallot 125
 shallow end 239
 shampoo 38
 shapes 164
 share price 97
 shares 97
 shark 294
 sharp 256
 shaving 73
 shaving foam 73
 shears 89
 shed 84
 sheep 185
 sheep farm 183
 sheep's milk 137
 sheet 71, 74, 241
 shelf 67, 106
 shell 129, 137, 265, 293
 shelled 129
 shelves 66
 sherbet 141
 sherry 145
 shiatsu 54
 shield 88
 shin 12
 ship 214
 ships 215
 shipyard 217
 shirt 33
 shock 47
 shocked 25
 shoe department 104
 shoe store 114
 shoes 34, 37
 shoot v 223, 227
 shop 298
 shopping 104
 shopping bag 106
 shopping center 104
 shops 114
 short 32, 321
 short wave 179
 short-grain 130
 shorts 30, 33
 shot 151
 shotgun 234
 shoulder 13
 shoulder bag 37
 shoulder blade 17
 shoulder pad 35
 shoulder strap 37
 shout v 25
 shovel 187
 shower 72, 286
 shower block 266
 shower curtain 72
 shower door 72
 shower gel 73
 shower head 72
 showjumping 243
 shuffle v 273
 shutoff valve 61
 shutter 58
 shutter release 270
 shuttle bus 197
 shuttlecock 231
 shy 25
 Siberia 313
 Sicily 316
 side 164
 side effects 109
 side mirror 198
 side order 153
 side plate 65
 side-saddle 242
 side street 299
 sidedeck 240
 sideline 220, 226, 230
 sidewalk 298
 sidewalk café 148
 Sierra Leone 317
 sieve 68, 89
 sieve v 91
 sift v 138
 sigh v 25
 sightseeing 260
 sign 104
 signal 209
 signature 96, 98
 silk 277
 silo 183
 silt 85
 silver 235, 289
 simmer v 67
 Singapore 319
 singer 191
 single 151
 single room 100
 singles 230
 sink 38, 60, 61, 66, 72
 sinus 19
 siren 94
 sirloin steak 119
 sister 22
 sister-in-law 23
 site manager's office 266
 situp 251
 six 308
 six hundred 308
 sixteen 308
 sixteenth 309
 sixth 309
 sixtieth 309
 sixty 308
 skate 120, 247, 294
 skate v 224
 skate wings 120
 skateboard 249
 skateboarding 249, 263
 skein 277
 skeleton 17
 sketch 275
 sketch pad 275
 skewer 68
 ski 241, 246
 ski boot 246
 ski jacket 246
 ski jump 247
 ski pole 246
 ski run 246
 ski slope 246
 skier 246
 skiing 246
 skim milk 136
 skin 14, 119, 128
 skin care 108
 skinned 121
 skirt 30, 34
 skull 17
 skydiving 248
 skyscraper 299, 300
 slalom 247
 slate 288
 sledding 247
 sledgehammer 187
 sleeper 30
 sleeping 74
 sleeping bag 267
 sleeping compartment
 209
 sleeping mat 267
 sleeping pill 109
 sleet 286
 sleeve 34
 sleeveless 34
 slice 119, 139, 140, 230
 slice v 67
 sliced bread 138
 slicer 139
 slide 167, 263
 slide v 229
 sling 46
 slip 35
 slip-on 37
 slippers 31
 slope 284
 slotted spatula 68
 slotted spoon 68
 Slovakia 316
 Slovenia 316
 slow 321
 slug 295
 small 321
 small intestine 18
 small of back 13
 smartphone 176
 smash 231
 smile 25
 smoke 95
 smoke alarm 95
 smoked 118, 121, 143,
 159
 smoked fish 143
 smoking 112
 snack bar 113, 148
 snail 295

- snake 293
snare drum 257
sneeze 44
snore *v* 71
snorkel 239
snout 293
snow 287
snowboarding 247
snowmobile 247
snowsuit 30
soak *v* 130
soap 73, 178
soap dish 73
soap 220, 222
soccer field 220
soccer player 220
soccer uniform 31, 222
socket 60, 80
socket wrench 80
socks 33
soda bread 139
soda water 144
sofa 62
sofabed 63
soft 129, 321
soft cheese 136
soft drink 154
soft drinks 144
soft toy 75
software 176
softwood 79
soil 85
solar system 280
solder 79, 80
solder *v* 79
soldering iron 81
soldier 189
sole 15, 37
solids 164
Solomon Islands 319
soluble 109
solvent 83
Somalia 317
somersault 235
son 22
sonata 256
song 259
son-in-law 22
sorrel 123
sorting unit 61
soufflé 158
soufflé dish 69
sound boom 179
sound technician 179
soundtrack 255
soup 153, 158
soup bowl 65
soup spoon 65
sour 127
sour cream 137
sourdough bread 139
south 312
South Africa 317
South Korea 318
South Sudan 317
Southern Hemisphere 283
Southern Ocean 313
souvenirs 260
sow *v* 90, 183
soybeans 131
space 280
space exploration 281
space heater 60
space shuttle 281
space station 281
space suit 281
spade 88, 265, 273
Spain 316
spare tire 203
spark plug 203
sparkling 144
sparring 237
sparrow 292
spatula 68, 167
speaker 174, 176, 258, 268
speaker stand 268
spearfishing 245
specials 152
spectators 233
speed limit 195
speed skating 247
speedboat 241
speedometer 201, 204
spell *v* 162
sperm 20
sphere 164
spices 132
spicy sausage 142
spider 295
spike *v* 90
spikes 233
spin 230
spin *v* 76
spin-dryer 76
spinach 123
spine 17
spire 300
spleen 18
splint 47
splinter 46
split ends 39
split peas 131
spoke 207
sponge 73, 74, 83
sponge cake 140
spool 245
spoon 65
sport fishing 245
sports 105, 220, 236, 248
sports car 198
sports field 168
sportcoat 33
sportsman 191
spotlight 259
sprain 46
spray 109
spray *v* 91
spray can 311
spray bottle 89
spring 71, 307
spring balance 166
spring greens 123
springboard 235, 238
sprinkler 89
sprinter 234
sprocket 207
spy hole 59
square 164, 165, 272, 299
square foot 310
square meter 310
squash 231
squat 251
squid 121, 295
squirrel 290
Sri Lanka 318
St. Kitts and Nevis 314
St. Lucia 314
St. Vincent and the Grenadines 314
stable 185, 243
stadium 223
staff 175, 256
stage 167, 254
stages 23
stainless steel 79
stair gate 75
staircase 59
stake 90
stake *v* 91
stalk 122, 297
stalls 254
stamen 297
stamp 98
stamp collecting 273
stamps 112
stance 232
stand 88, 205, 268
stapler 173
staples 173
star 280
star anise 133
starfish 295
starfruit 128
start school *v* 26
starter 153
starting block 234, 238
starting line 234
state 315
statement 180
stationery 105
steak 121
steam *v* 67
steam train 208
steamed 159
steepchase 243
steel wool 81
steering wheel 201
stem 111, 112, 297
stencil 83
stenographer 181
step machine 250
stepdaughter 23
stepfather 23
stepladder 82
stepmother 23
stepson 23
stereo 269
stereo system 268
sterile 47
stern 240
stethoscope 45
stew 158
stick 224, 249
sticks 133
still 144
sting 46, 295
stir *v* 67
stir-fry 158
stirrer 150
stirrup 242
stitch 277
stitch selector 276
stitches 52
stock broker 97
stock exchange 97
stocking 35
stocks 97, 110
stomach 18
stomachache 44
stone 36, 275
stone fruit 126
stop 269
stop button 197
stopper 166
stopwatch 234
store directory 104
stork 292
storm 287
stout 145
straight 39, 165
straight ahead 260
straighten *v* 39
straighteners 38
strap 35
strapless 34
stratosphere 286
straw 144, 154
strawberry 127
strawberry milkshake 149
stream 285
streaming 269
street 298
street corner 298
street sign 298
streetlight 298
stress 55
stretch 251
stretcher 94
strike 228, 237
string 230, 258
string of pearls 36
string bean 122
strings 256
strip *v* 82
stroke 44, 233, 239
strokes 231
stroller 75
strong 321
stub 96
study 63, 162
stuffed 159
stuffed olive 143
stump 225
styles 39, 239, 301
submarine 215
subsoil 91
substitute 223
substitution 223
subtract *v* 165
suburb 299
subway map 209
subway train 209
succulent 87
suction hose 77
Sudan 317
sugarcane 184
suit 273
sulfur 289
summer 31, 307
summons 180
sumo wrestling 237
Sun 280
sun hat 30, 265
sunbathe *v* 264
sunbed 41
sunblock 108, 265
sunburn 46
Sunday 306
sunflower 184, 297
sunflower oil 134
sunflower seed 131
sunglasses 51, 265
sunny 286
sunrise 305
sunroof 202
sunscreen 108
sunset 305
sunshine 286
suntan lotion 265
supermarket 106
supersonic jet 211
supplement 55
supply pipe 61
support 187
suppository 109
surf 241
surfboard 241
surfcasting 245
surfer 241
surfing 241
surgeon 48
surgery 45, 48
Suriname 315
surprised 25

- suspect 94, 181
suspension 203, 205
swallow 292
swamp 285
swan 293
Swaziland 317
sweater 33
sweatshirt 33
Sweden 316
sweep *v* 77
sweet 124, 127, 155
sweet potato 125
sweet spreads 134
sweetcorn 124
swim *v* 238
swimmer 238
swimming 238
swimming pool 101, 238, 250
swimsuit 238, 265
swing *v* 232
swings 263
swiss chard 123
switch 60
Switzerland 316
swivel chair 172
sword 236
swordfish 120, 294
symphony 256
synagogue 300
synchronized swimming 239
synthetic 31
Syria 318
syringe 109, 167
syrup 109
system 176
- T**
tab 173
table 64, 148
table tennis 231
tablecloth 64
tachometer 201
tack *v* 241, 277
tackle 245
tackle *v* 220, 223
tackle box 244
tadpole 294
tae kwon do 236
tag *v* 229
tai chi 236
tail 121, 210, 242, 280, 290, 294
tailbone 17
tailgate 198
taillight 204
tailor 191
tailored 35
tailor's 115
tailor's chalk 276
tailor's dummy 276
tailplane 210
Taiwan 319
- Tajikistan 318
take a bath *v* 72
take a shower *v* 72
take notes *v* 163
take off *v* 211
talcum powder 73
tall 321
tambourine 257
tampon 108
tan 41
tandem 206
tangerine 126
tank 61
Tanzania 317
tap 61, 66
tap water 144
tape deck 268
tape dispenser 173
tape measure 80, 276
target 249
target shooting 249
taro root 124
tarragon 133
Tasmania 319
tattoo 41
tax 96
taxi stand 213
tea 144, 149, 184
tea bag 144
tea with lemon 149
tea with milk 149
teacher 162, 191
teacup 65
team 220, 229
teapot 65
tear 51
teaspoon 65
teat 75
techniques 79, 159
teddy bear 75
tee 233
teeing ground 232
teenager 23
tee off *v* 233
telegram 98
telephone 99
telephone booth 99
teleprompter 179
telescope 281
television 268
television series 178
television studio 178
temperature 286
temperature gauge 201
temple 14, 300
ten 308
ten thousand 309
tenant 58
tend *v* 91
tendon 17
tennis 230
tennis court 230
tennis shoes 231
tenon saw 81
- tent 267
tent peg 266
tent pole 266
tenth 309
tequila 145
terminal 212
termite 295
terrace café 148
territory 315
test 49, 163
test tube 166
text (SMS) 99
text message 99
textbook 163
Thailand 318
thank you 322
Thanksgiving 27
theater 254, 299
theme park 262
therapist 55
thermal underwear 35
thermals 267
thermometer 45, 167
thermosphere 286
thermostat 61
thesis 169
thick 321
thigh 12, 119
thimble 276
thin 321
third 309
third floor 104
thirteen 308
thirteenth 309
thirtieth 309
thirty 308
this way up 98
this week 307
thistle 297
thoracic vertebrae 17
thread 276
thread *v* 277
thread guide 276
thread reel 276
three 308
three hundred 308
hatchback 200
three-point line 226
thriller 255
throat 19
throttle 204
through 320
throw 237
throw *v* 221, 227, 229
throw-in 223, 226
thruster 281
thumb 15
thumbtack 173
thunder 286
Thursday 306
thyme 133
thyroid gland 18
tibia 17
- ticket 209, 213
ticket gate 209
ticket inspector 209
ticket office 209, 216
tie 32
tiebreaker 230
tie-pin 36
tiger 291
tights 35, 251
tile 58, 272
tile *v* 82
till 106, 150
tiller 240
timber 187
time 234, 304
time out 220
timer 166
times 165, 261
timing 203
tip 36, 122, 246
tissue 108
title 168
titles 23
to 320
to go 154
toad 294
toast 157
toasted sandwich 149
toaster 66
tobacco 112, 184
today 306
toddler 30
toe 15
toe clip 207
toe strap 207
toenail 15
toffee 113
toggle 31
Togo 317
toilet 61, 72
toilet brush 72
toilet paper 72
toilet seat 72
toiletries 41, 107
toilets 104, 266
toll booth 194
tomato 125, 157
tomato juice 144, 149
tomorrow 306
ton 310
toner 41
tongs 150, 167
tongue 19, 37, 118
tonic water 144
tool rack 78
toolbar 177
toolbelt 186
toolbox 80
tools 187
tooth 50
toothache 50
toothbrush 72
toothpaste 72
top coat 83
- top-dress *v* 90
top tier 141
topaz 288
topiary 87
topping 155
topsoil 85
tornado 287
tortoise 293
tossed salad 158
touch line 221
touchdown 221
tour bus 197, 260
tour guide 260
tourer 205
touring bike 206
tourist 260
tourist attraction 260
tourist information 261
tourmaline 288
tournament 233
tow away *v* 195
tow truck 203
toward 320
towel bar 72
towels 73
tower 300
town 298
town hall 299
townhouse 58
toy 75
toy basket 75
toys 105
track 208, 234
track and field 234
tractor 182
traffic 194
traffic jam 195
traffic light 194
traffic police 195
trailer 266
train 35, 208
train *v* 91, 251
train station 208
trainer 37
training wheels 207
tram 196, 208
transfer 223
transformer 60
transmission 202
transplant *v* 91
transportation 194
trapezium 164
trapezius 16
trash 177
travel agent 190, 114
travel brochure 212
travel sickness pills 109
traveler's check 97
tray 152, 154
tray-table 210
tread 207
tread water *v* 239
treadmill 250
treble clef 256

triangle 164, 257
triceps 16
trifle 141
trim v 39, 90
trimester 52
trimmer 88
Trinidad and Tobago 314
tripod 166, 270, 281
trolley bus 196
trombone 257
tropic of Cancer 283
tropic of Capricorn 283
tropical fruit 128
tropics 283
troposphere 286
trot 243
trough 183
trout 120
trowel 89, 187
truck 194
truck driver 190
truffle 113, 125
trumpet 257
trunk 198, 291, 296
trunks 238
try 221
T-shirt 30, 33
tub 311
tuba 257
tube 311
Tuesday 306
tugboat 215
tulip 111
tumble 235
tumble-dryer 76
tumbler 65
tuna 120
tune v 179
tune the radio v 269
tuning peg 258
Tunisia 317
turbocharger 203
turf v 90
Turkey 316
turkey 119, 185, 293
Turkmenistan 318
turmeric 132
turn 238
turn v 79
turn off the television v 269
turn on the television v 269
turn signal 198, 204
turnip 124
turpentine 83
turquoise 289
turret 300
turtle 293
tusk 291
tutu 191
tweezers 40, 47, 167
twelfth 309
twelve 308

twentieth 309
twenty 308
twenty minutes 304
twenty thousand 309
twenty-first 309
twenty-one 308
twenty-second 309
twenty-third 309
twenty-two 308
twig 296
twin bed 71
twin room 100
twine 89
twins 23
twist ties 89
two 308
two hundred 308
two o'clock 304
two thousand 307
two thousand and one 307
two-door 200
types 199, 205
types of buses 196
types of cameras 270
types of farms 183
types of plants 86
types of fishing 245
types of trains 208
tire 198, 205, 206
tire iron 207
tire pressure 203

U
Uganda 317
ugli fruit 126
Ukraine 316
ulna 17
ultralight 211
ultrasound 52
ultraviolet rays 286
umbilical cord 52
umbrella 36, 233
umbrella stand 59
umpire 225, 229, 230
uncle 22
unconscious 47
uncooked meat 142
under 320
under par 233
undercoat 83
underexposed 271
undergraduate 169
underpass 194
underwear 32, 35
underwired 35
uniform 94, 189
United Arab Emirates 318
United Kingdom 316
United States of America 314
universe 280
university 299

unleaded 199
unpasteurized 137
unpick v 277
unsalted 137
until 320
up 320
upset 25
Uranus 280
ureter 21
urethra 20
urinary 19
urology 49
Uruguay 315
usher 255
uterus 20, 52
utility knife 81
utility room 76
Uzbekistan 318

V
vacation 212
vacuum cleaner 77, 188
vacuum cup 53
vacuum flask 267
vagina 20
valance 71
valley 284
valve 207
vanilla 132
Vanuatu 319
varnish 79, 83
vas deferens 21
vase 63, 111
Vatican City 316
vault 235, 300
veal 118
vegetable garden 85, 182
vegetable oil 135
vegetable peeler 68
vegetables 107, 122, 124
veggie burger 155
veil 35
vein 19
venetian blind 63
Venezuela 315
venison 118
vent 283
Venus 280
verdict 181
vest 33, 35, 251
veterinarian 189
vibraphone 257
video game 269
video phone 99
video tape 269
Vietnam 318
viewfinder 271
village 299
vine 183
vinegar 135, 142
vineyard 183
vintage 199

viola 256
violin 256
virus 44
visa 213
vise 78
vision 51
visiting hours 48
visor 205
vitamins 108
V-neck 33
vocal cords 19
vodka 145
voice message 99
volcano 283
volley 231
volleyball 227
voltage 60
volume 165, 179, 269, 311
vomit v 44

W
waders 244
wading pool 263
waffles 157
waist 12
waistband 35
waistcoat 33
waiter 148, 152
waiting room 45
waitress 191
wake up v 71
walk 243
walking boot 37, 267
walkway 212
wall 58, 186, 222
wall light 62
wallet 37
wallpaper 82, 177
wallpaper v 82
wallpaper brush 82
wallpaper paste 82
walnut 129
walnut oil 134
walrus 290
ward 48
wardrobe 70
warehouse 216
warm 286
warm up v 251
warrant 180
wash v 38, 77
washer 80
washer fluid 199
washer fluid reservoir 202
washing machine 76
wasp 295
waste disposal 61, 266
waste disposal unit 61
waste pipe 61
wastebasket 172
watch 36
watch television v 269

water 144, 238
water v 90, 183
water bottle 206, 267
water chamber 61
water chestnut 124
water garden 84
water hazard 232
water heater 61
water jet 95
water plant 86
water polo 239
watercolor paints 274
watercross 123
waterfall 285
watering 89
watering can 89
watermelon 127
waterskier 241
waterskiing 241
watersports 241
wave 241, 264
wavelength 179
wax 41
weak 321
weather 286
weaving 277
website 177
wedding 26, 35
wedding cake 141
wedding dress 35
wedding reception 26
wedge 37, 233
Wednesday 306
weed v 91
weedkiller 91
weeds 86
week 306
weekend 306
weekly 307
weigh v 310
weight 166, 244
weight bar 251
weight belt 239
weight training 251
wellington boots 31
west 312
western 255
Western Sahara 317
wet 286, 321
wet wipe 75, 108
wetsuit 239
whale 290
wheat 130, 184
wheel 198, 207
wheel nuts 203
wheelbarrow 88
wheelchair 48
wheelchair access 197
whetstone 81
whiplash 46
whipped cream 137
whisk 68
whisk v 67
whiskers 290

- whiskey 145
 white 39, 145, 272, 274
 white bread 139
 white chocolate 113
 white coffee 148
 white currant 127
 white flour 138
 white meat 118
 white rice 130
 whiting 120
 whole 129, 132
 whole milk 136
 whole-grain 131
 whole-grain mustard 135
 whole-wheat bread 139
 whole-wheat flour 138
 wicket 225
 wide 321
 width 165
 wife 22
 Wifi 269
 wig 39
 wild rice 130
 willow 296
 win v 273
 wind 241, 286
 windbreak 265
 windlass 214
 window 58, 96, 98, 177,
 186, 197, 209, 210
 windpipe 18
 windshield 198, 205
 windshield wiper 198
 windsurfer 241
 windsurfing 241
 windy 286
 wine 145, 151
 wine glass 65
 wine list 152
 wine vinegar 135
 wing 119, 210, 293
 wings 254
 winner 273
 winter 31, 307
 winter sports 247
 wipe v 77
 wire 79
 wire cutter 80
 wire strippers 81
 wires 60
 with 320
 withdrawal slip 96
 without 320
 witness 180
 wok 69
 wolf 290
 woman 23
 womb 52
 women's clothing 34,
 105
 wood 79, 233, 275, 285
 wood glue 78
 wood shavings 78
 wood stain 79
 wooden spoon 68
 woodpecker 292
 woodwind 257
 woodworking 275
 wool 277
 work 172
 work day 306
 workbench 78
 workshop 78
 world map 312
 worm 295
 worried 25
 wound 46
 wrap 155
 wrapping 111
 wreath 111
 wrench 80, 81, 203
 wrestling 236
 wrinkle 15
 wrist 13, 15
 wristband 230
 writ 180
 write v 162
X
 X-ray 48
 X-ray film 50
 X-ray machine 212
 X-ray viewer 45
Y
 yacht 215, 240
 yam 125
 yard 310
 yawn v 25
 year 163, 306
 yeast 138
 yellow 274
 yellow card 223
 Yemen 318
 yes 322
 yesterday 306
 yoga 54
 yogurt 137
 yolk 137, 157
 you're welcome 322
 Yugoslavia 316
Z
 Zambia 317
 zebra 291
 zero 308
 zest 126
 Zimbabwe 317
 zinc 289
 zip 277
 ZIP code 98
 zone 315
 zones 283
 zoo 262
 zoology 169
 zoom lens 270
 zucchini 125

Dank • acknowledgments

DORLING KINDERSLEY would like to thank Tracey Miles and Christine Lacey for design assistance, Georgina Garner for editorial and administrative help, Sonia Gavira, Polly Boyd, and Cathy Meeus for editorial help, and Claire Bowers for compiling the DK picture credits.

The publisher would like to thank the following for their kind permission to reproduce their photographs:

Abbreviations key: a-above; b-below/bottom; c-center; f-far; l-left; r-right; t-top)

I23RF.com: Andriy Popov 34tl; Daniel Ernst 179tc; Hongqi Zhang 24cla. 175cr; Ingvar Bjork 60c; Kobby Dagan 259c; leonardo255 269c; Liubov Vadimovna (Luba) Nel 39cla; Ljupco Smokovski 75crb; Oleksandr Marynchenko 60bl; Olga Popova 33c; oneblink 49bc; Racorn 162tl; Robert Churchill 94c; Roman Gorielov 33bc; Ruslan Kudrin 35bc, 35br; Subbotina 39cra; Sutichak Yachaingkhom 39tc; Tarzhanova 37tc; Vitaly Valua 39tl; Wavebreak Media Ltd 188bl; Wilawan Khasawong 75cb;

Action Plus: 224bc; **Alamy Images:** 154t; A.T. Willett 287bcl; Alex Segre 105ca, 105cb, 195cl; Ambrophoto 24cra; Blend Images 168cr; Cultura RM 33r; Doug Houghton 107fbr; Ekkapon Sriharun 172bl; Hugh Threlfall 35tl; 176tr; Ian Allenden 48br; Ian Dagnall (iPod is a trademark of Apple Inc., registered in the U.S. and other countries) 268tc, 270t; Ievgen Chepil 250bc; imagebroker 199tl, 249c; Keith Morris 178c; Martyn Evans 210b; MBI 175tl; Michael Burrell 213cra; Michael Foyle 184bl; Oleksiy Maksymenko 105tc; Paul Weston 168br; Prisma Bildagentur AG 246b; Radharc Images 197tr; RBtravel 112tl; Ruslan Kudrin 176tl; Sasa Huzjak 258t; Sergey Kravchenko 37ca; Sergio Azenha 270bc; Stanca Sanda (iPad is a trademark of Apple Inc., registered in the U.S. and other countries) 176bc; Stock Connection 287bcr; tarczas 35cr; vityalysuprun 176cl; Wavebreak Media Ltd 39cl, 174b, 175tr; **Allsport/Getty Images:** 238cl; **Alvey and Towers:** 209acr, 215bcl, 215bcr, 241cr; **Peter Anderson:** 188cbr, 271br.

Anthony Blake Photo Library: Charlie Stebbings 114cl; John Sims 114tcl; **Andyalt:** 98tl; **apple mac computers:** 268tr; **Arcaid:** John Edward Linden 301bl; Martine Hamilton Knight, Architects: Chapman Taylor Partners, 213cl; Richard Bryant 301br; **Argos:** 41tcl, 66cbl, 66cl, 66br, 66bcl, 69cl, 70bcl, 71t, 77tl, 269tc, 270tl; **Axiom:** Eitan Simanon 105bcr; Ian Cumming 104; Vicki Couchman 148cr; **Beken Of Cowes Ltd:** 215cb; **Bosch:** 76ctr, 76tc, 76tcl; **Camera Press:** 38tr, 256t, 257cr; Barry J. Holmes 148tr; Jane Hanger 159cr; Mary Germanou 259bc; **Corbis:** 78b; Anna Clopet 247tr; Ariel Skelley / Blend Images 52l; Bettmann 181tl, 181tr; Blue Jean Images 48bl; Bo Zauders 156t; Bob Rowan 152bl; Bob Winsett 247cbl; Brian Bailey 247br; Carl and Ann Purcell 162l; Chris Rainer 247ct; Craig Aurness 215bl; David H.Wells 249cbr; Dennis Marsico

274bl; Dimitri Lundt 236bc; Duomo 211tl; Gail Mooney 277ctr; George Lepp 248c; Gerald Nowak 239b; Gunter Marx 248cr; Jack Hollingsworth 231bl; Jacqui Hurst 277cbr; James L. Amos 247bl, 191ctr, 220bcr; Jan Butchofsky 277cbr; Johnathan Blair 243cr; Jose F. Poblete 191br; Jose Luis Pelaez.Inc 153tc; Karl Weatherly 220bl, 247ctr; Kelly Mooney Photography 259tl; Kevin Fleming 249bc; Kevin R. Morris 105tr, 243tl, 243tc; Kim Sayer 249ctr; Lynn Goldsmith 258t; Macduff Everton 231bcl; Mark Gibson 249bl; Mark L. Stephenson 249tcl; Michael Pole 115tr; Michael S. Yamashita 247ctcl; Mike King 247cbl; Neil Rabinowitz 214br; Pablo Corral 115bc; Paul A. Sounders 169br, 249ctcl; Paul J. Sutton 224c, 224br; Phil Schermeister 227b, 248tr; R. W Jones 309; Richard Morrell 189bc; Rick Doyle 241ctr; Robert Holmes 97br, 277ct; Roger Ressmeyer 169tr; Russ Schleipman 229; The Purcell Team 211ctr; Vince Streato 194t; Wally McNamee 220br, 220bcl, 224bl; Wavebreak Media LTD 191bc; Yann Arhus-Bertrand 249tl; **Demetrio Carrasco / Dorling Kindersley (c) Herge / Les Editions Casterman:** 112ccl; **Dorling Kindersley:** Banbury Museum 35c; Five Napkin Burger 152t; **Dixons:** 270cl, 270cr, 270bl, 270bcl, 270bcr, 270ccr; **Dreamstime.com:** Alexander Podshivalov 179tr, 191cr; Alexxl66 268tl; Andersastphoto 176tc; Andrey Popov 191bl; Arne9001 190tl; Chaos 26c; Designstock 269cl; Monkey Business Images 26cbl; Paul Michael Hughes 162tr; Serghei Starus 190bc; **Education Photos:** John Walmsley 26tl; **Empics Ltd:** Adam Day 236br; Andy Heading 243c; Steve White 249cbr; **Getty Images:** 48bcl, 100t, 114bcr, 154bl, 287tr; 94tr; Don Farrall / Digital Vision 176c; Ethan Miller 270bl; Inti St Clair 179bl; Liam Norris 188br; Sean Justice / Digital Vision 24br; **Dennis Gilbert:** 106tc; **Hulsta:** 70t; **Ideal Standard Ltd:** 72r; **The Image Bank/Getty Images:** 58; **Impact Photos:** Eliza Armstrong 115cr; Philip Achache 246t; **The Interior Archive:** Henry Wilson, Alfie's Market 114bl; Luke White, Architect: David Mikhail, 59tl; Simon Upton, Architect: Philippe Starck, St Martins Lane Hotel 100bcr, 100br; **iStockphoto.com:** asterix0597 163tl; EdStock 190br; RichLegg 26bc; SorinVidis 27cr; **Jason Hawkes Aerial Photography:** 216t; **Dan Johnson:** 35r; **Kos Pictures Source:** 215cbl, 240tc, 240tr; David Williams 216b; **Lebrecht Collection:** Kate Mount 169bc; **MP Visual.com:** Mark Swallow 202t; **NASA:** 280cr, 280ccl, 281tl; **P&O Princess Cruises:** 214bl; **P A Photos:** 181br; **The Photographers' Library:** 186bl, 186bc, 186t; **Plain and Simple Kitchens:** 66t; **Powerstock Photolibrary:** 169tl, 256t, 287tc; **PunchStock:** Image Source 195tr; **Rail Images:** 208c, 208cbl, 209br; **Red Consultancy:** Odeon cinemas 257br; **Redferns:** 259br; Nigel Crane 259c; **Redx**

Features: 106br, 259tc, 259tr, 259bl, 280b; Charles Ommaney 114ctr; J.F.F Whitehead 243cl; Patrick Barth 101tl; Patrick Frilet 189cbl; Scott Wiseman 287bl; **Royalty Free Images:** Getty Images/Eyewire 154bl; **Science & Society Picture Library:** Science Museum 202b; **Science Photo Library:** IBM Research 190cla; NASA 281cr; **SuperStock:** Ingram Publishing 62; Juanma Aparicio / age fotostock 172t; Nordic Photos 269tl; **Skyscan:** 168t, 182c, 298; Quick UK Ltd 212; **Sony:** 268bc; **Robert Streeter:** 154br; **Neil Sutherland:** 82tr, 83tl, 90t, 118, 188ctr, 196t, 196tr, 299cl, 299bl; **The Travel Library:** Stuart Black 264t; **Travelex:** 97cl; **Vauxhall:** Technik 198t, 199tl, 199tr, 199cl, 199cr, 199ctcl, 199ctr, 199tcl, 199tr, 200; **View Pictures:** Dennis Gilbert, Architects: ACDP Consulting, 106t; Dennis Gilbert, Chris Wilkinson Architects, 209tr; Peter Cook, Architects: Nicholas Crimshaw and partners, 208t; **Betty Walton:** 185br; **Colin Walton:** 2, 4, 7, 9, 10, 28, 42, 56, 92, 95c, 99tl, 99tcl, 102, 116, 120t, 138t, 146, 150t, 160, 170, 191ctcl, 192, 218, 252, 260br, 260l, 261tr, 261c, 261cr, 271cbl, 271cbr, 271ctcl, 278, 287br, 302, 401.

DK PICTURE LIBRARY:

Akhil Bahkshi; Patrick Baldwin; Geoff Brighting; British Museum; John Bulmer; Andrew Butler; Joe Cornish; Brian Cosgrove; Andy Crawford and Kit Houghton; Philip Dowell; Alistair Duncan; Gables; Bob Gathany; Norman Hollands; Kew Gardens; Peter James Kindersley; Vladimir Koziik; Sam Lloyd; London Northern Bus Company Ltd; Tracy Morgan; David Murray and Jules Selmes; Musée Vivant du Cheval, France; Museum of Broadcast Communications; Museum of Natural History; NASA; National History Museum; Norfolk Rural Life Museum; Stephen Oliver; RNLi; Royal Ballet School; Guy Ryecart; Science Museum; Neil Setchfield; Ross Simms and the Winchcombe Folk Police Museum; Singapore Symphony Orchestra; Smart Museum of Art; Tony Souter; Erik Svensson and Jeppe Wikstrom; Sam Tree of Keygrove Marketing Ltd; Barrie Watts; Alan Williams; Jerry Young.

Additional Photography by Colin Walton.

Colin Walton would like to thank: A&A News, Uckfield; Abbey Music, Tunbridge Wells; Arena Mens Clothing, Tunbridge Wells; Burrells of Tunbridge Wells; Gary at Di Marco's; Jeremy's Home Store, Tunbridge Wells; Noakes of Tunbridge Wells; Ottakar's, Tunbridge Wells; Selby's of Uckfield; Sevenoaks Sound and Vision; Westfield, Royal Victoria Place, Tunbridge Wells.

All other images © Dorling Kindersley
For further information see: www.dkimages.com