

Learn Beginning

Sounds

P

Preschool



Bag



Bug



Car

Coin

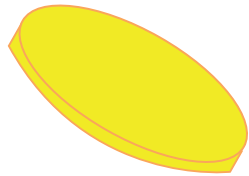
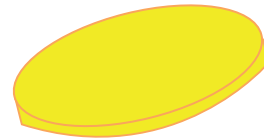
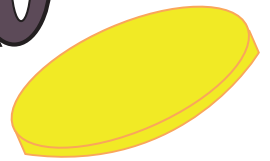

Dog



Alligator



Apple

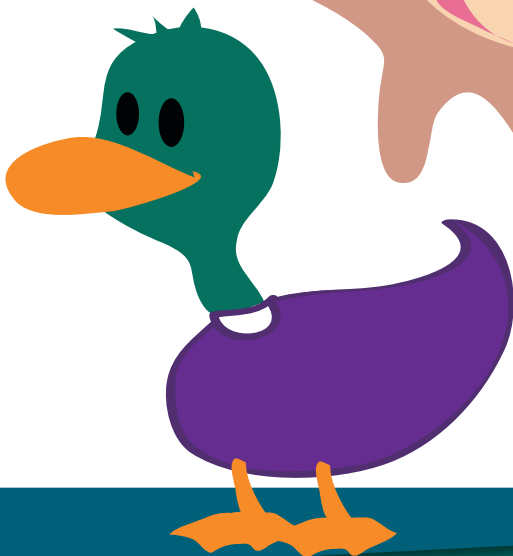

Table of Contents

Learn Beginning Sounds

The Letter "A"

The Letter "B"

Color the Letter "C"

The Letter "D"

The Letter "E"

Common Beginning #1

Beginning Sounds

The Letter "K"

The Letter "L"

The Letter "M"

The Letter "N"

Color the Letter "O"

Color the Letter "P"

Learn Beginning Sounds: N and Q

Learn Beginning Sounds: P and R

Common Beginning #2

Learn Beginning Sounds: T and S

The Letter "U"

Learn Beginning Sounds: V and W

Color the Letter "X"

Color the Letter "Y"

Color the Letter "Z"

Common Beginning #3

Certificate of Completion

Name: _____ Date: _____

The Letter "A"

Circle the objects that begin with the letter A.

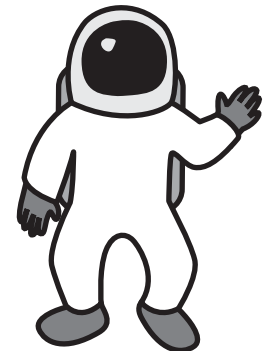
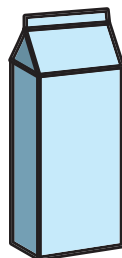
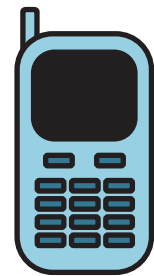
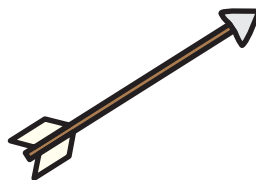
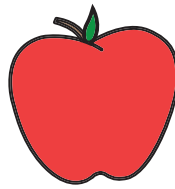
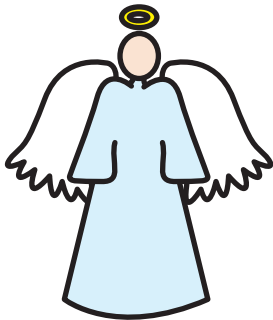
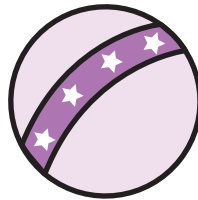
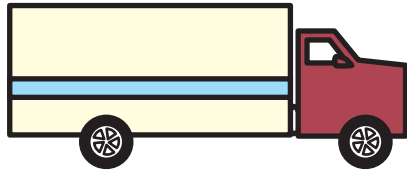

Name: _____ Date: _____

The Letter "B"

Circle the objects that begin with the letter B.

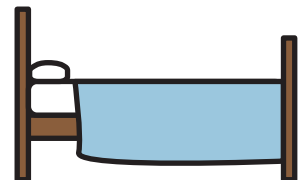
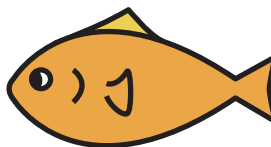
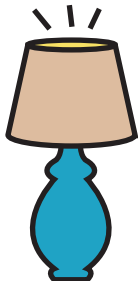
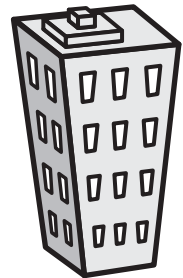
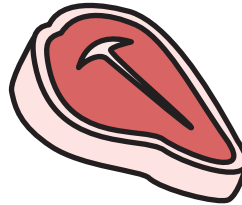
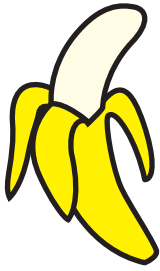
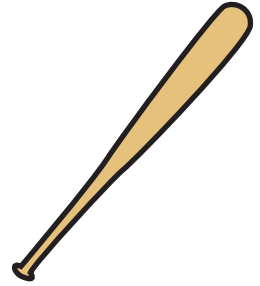
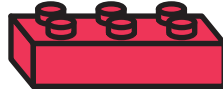
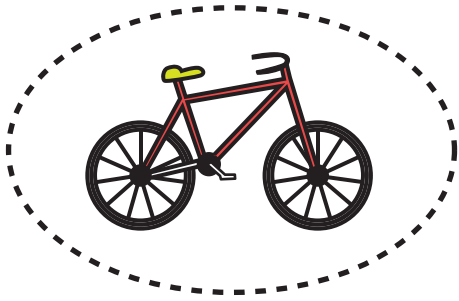

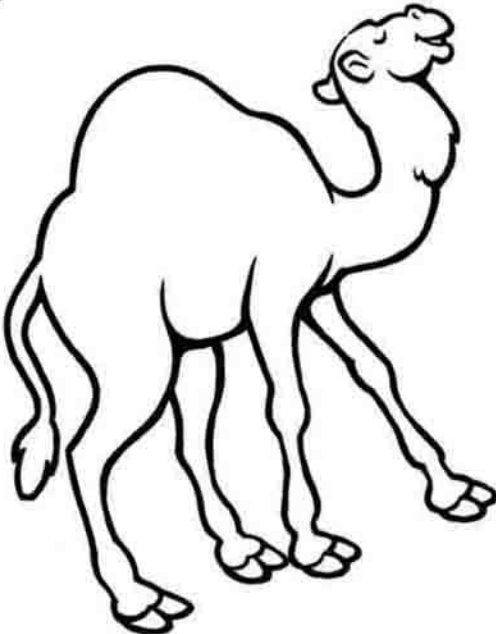
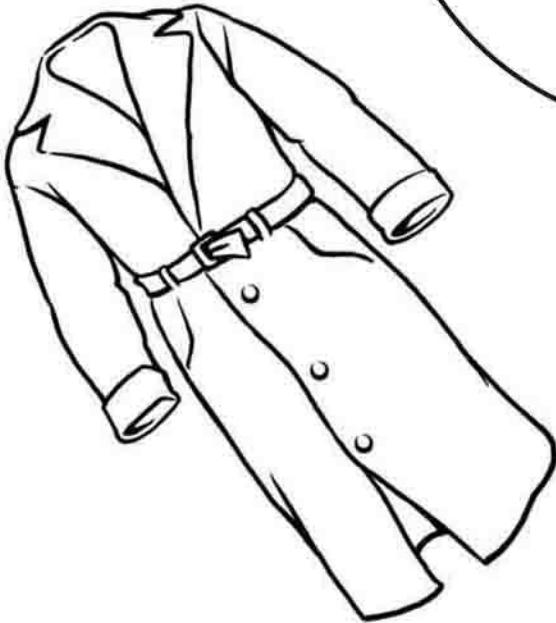
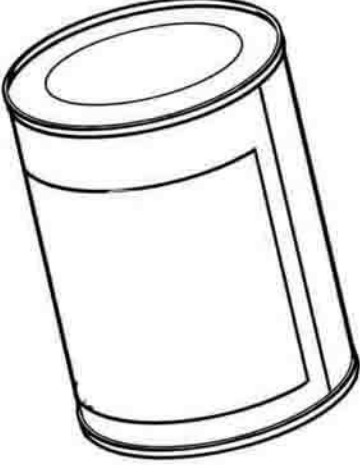
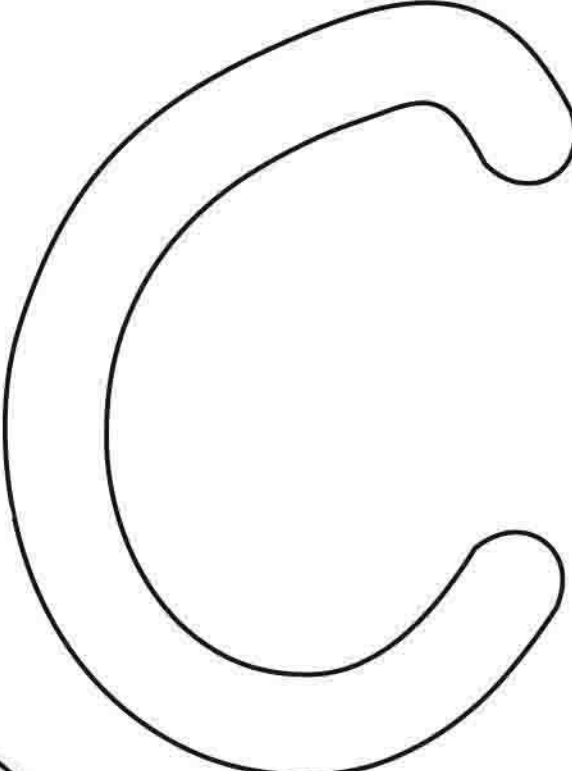
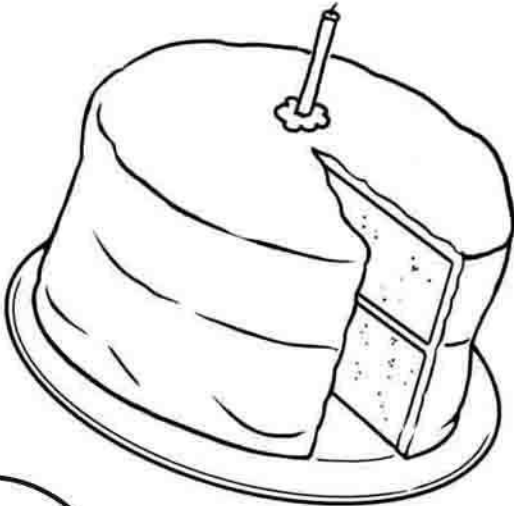
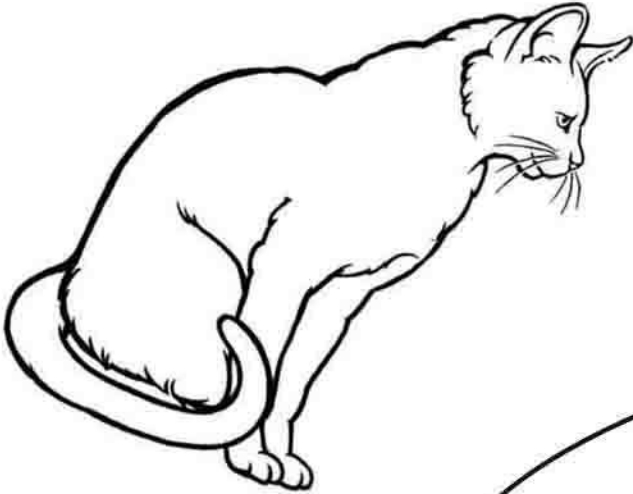

Name: _____ Date: _____

The Letter "D"

Circle the objects that begin with the letter D.

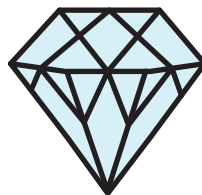
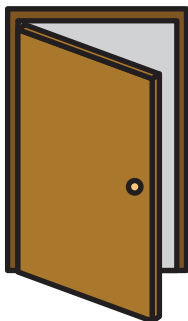
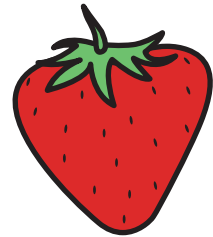
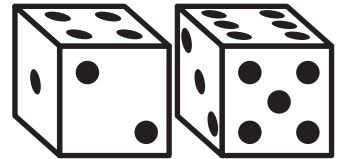
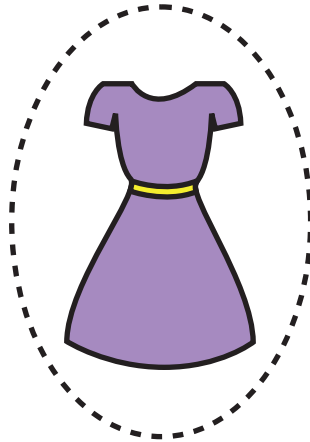
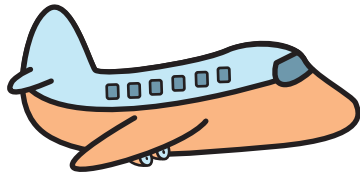

Name: _____ Date: _____

The Letter "E"

Circle the objects that begin with the letter E.

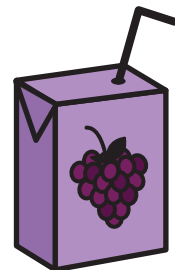
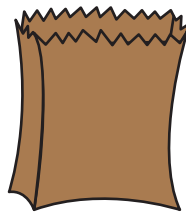
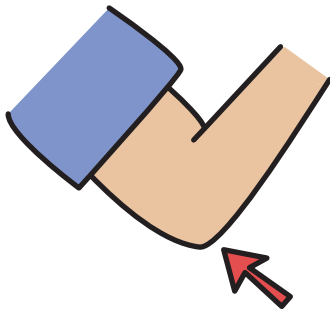
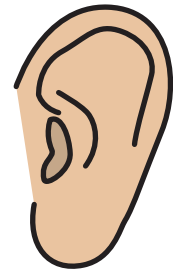
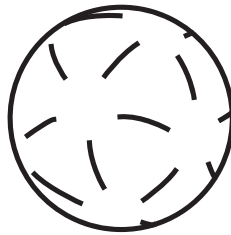
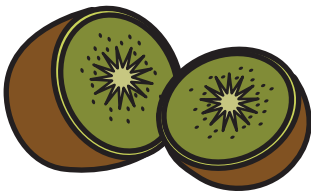
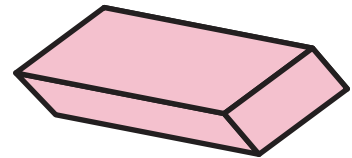
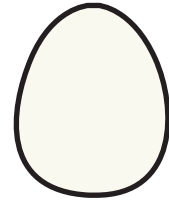
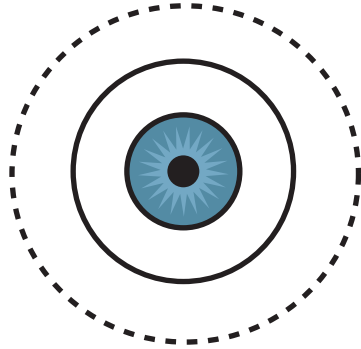

Common Beginning

Draw a line to match the words that have the same beginning sound.



Car

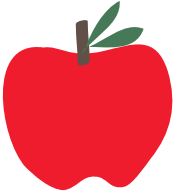

Apple

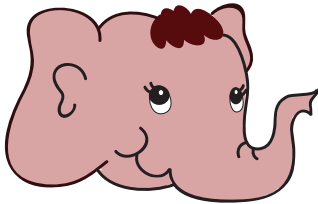

Elephant



Dog



Bug

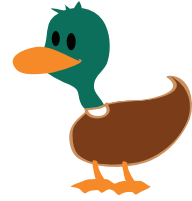

Duck

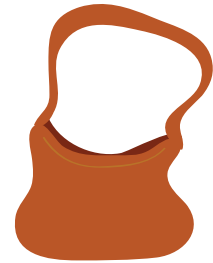

Bag

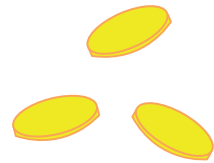

Coin

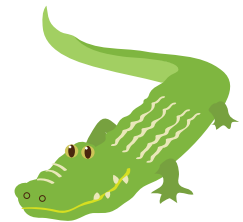

Alligator

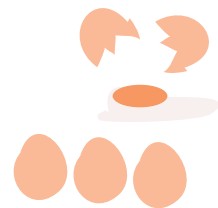

Eggs

Beginning Sounds

Draw a line matching each picture with the letter that makes its beginning sound.

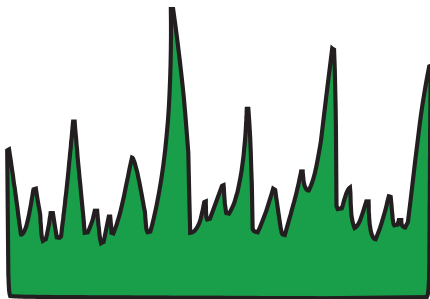
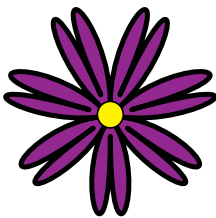
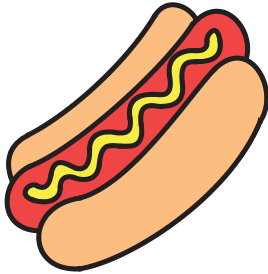

F

G

H

I

J

Name: _____ Date: _____

The Letter "K"

Circle the objects that begin with the letter K.

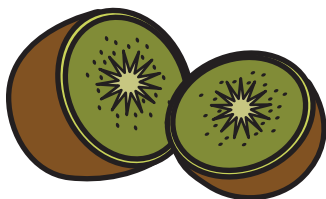
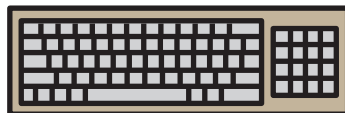
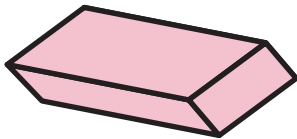
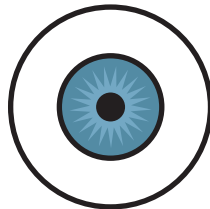
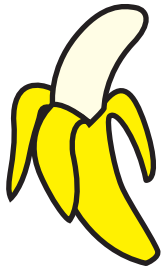
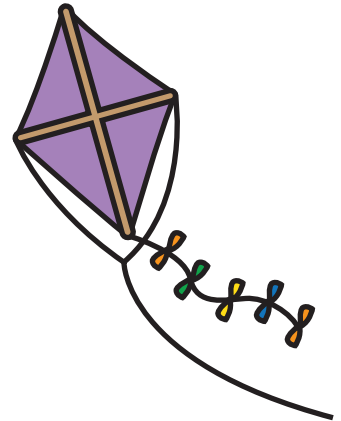
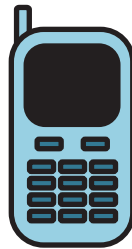
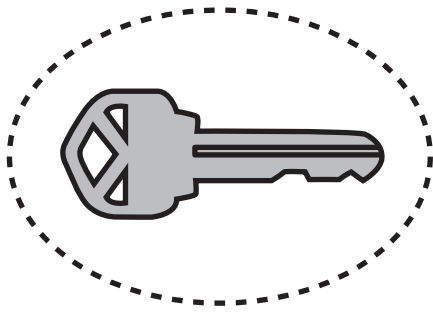

Name: _____ Date: _____

The Letter "L"

Circle the objects that begin with the letter L.

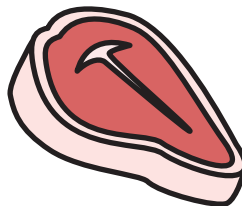
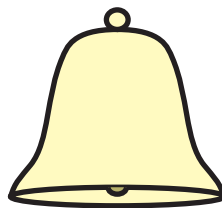
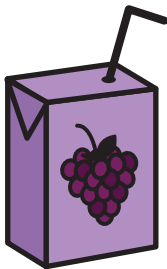
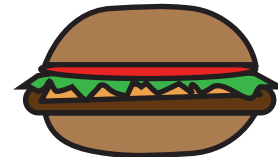
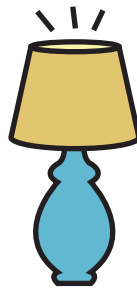
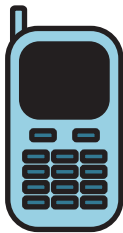
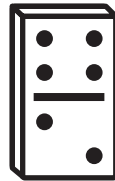
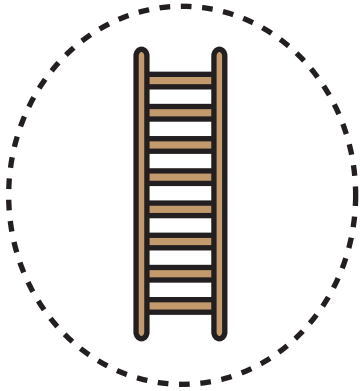

Name: _____ Date: _____

The Letter "M"

Circle the objects that begin with the letter M.

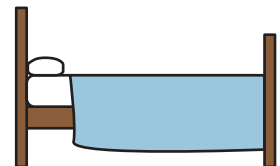
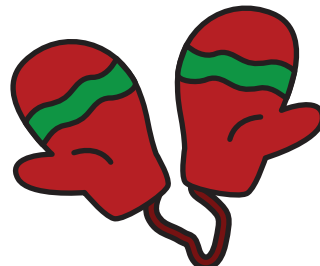
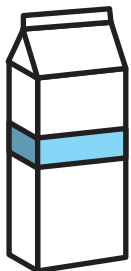
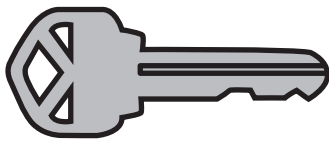
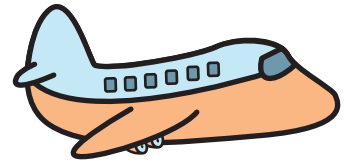
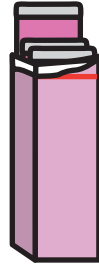
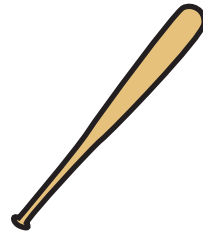

Name: _____ Date: _____

The Letter "N"

Circle the objects that begin with the letter N.

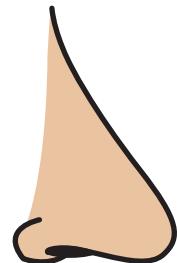
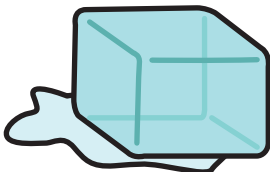
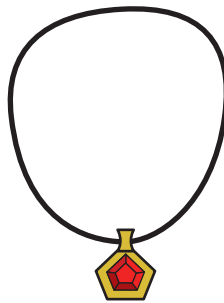
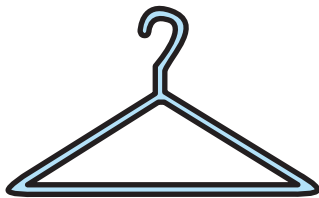
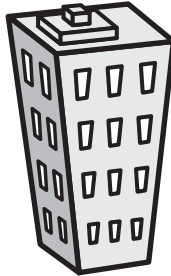
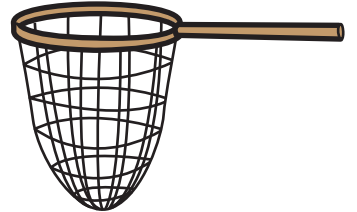
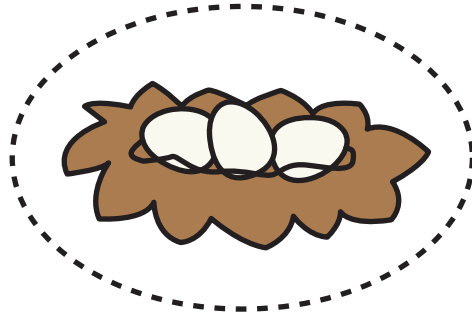
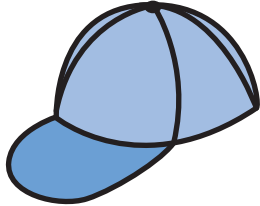

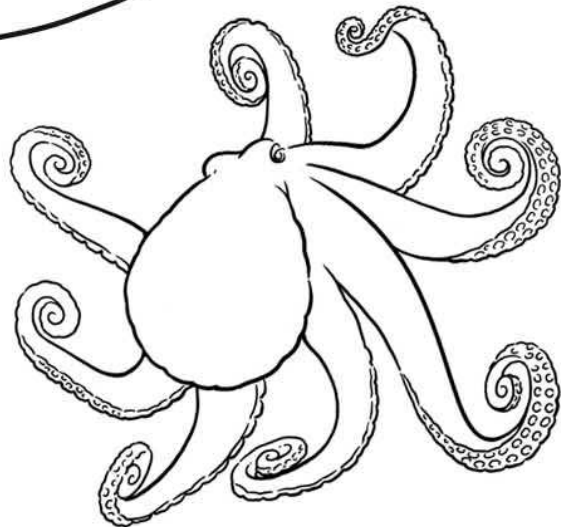
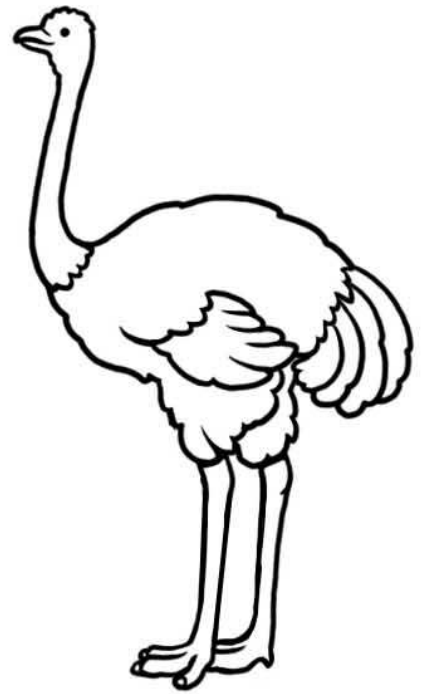
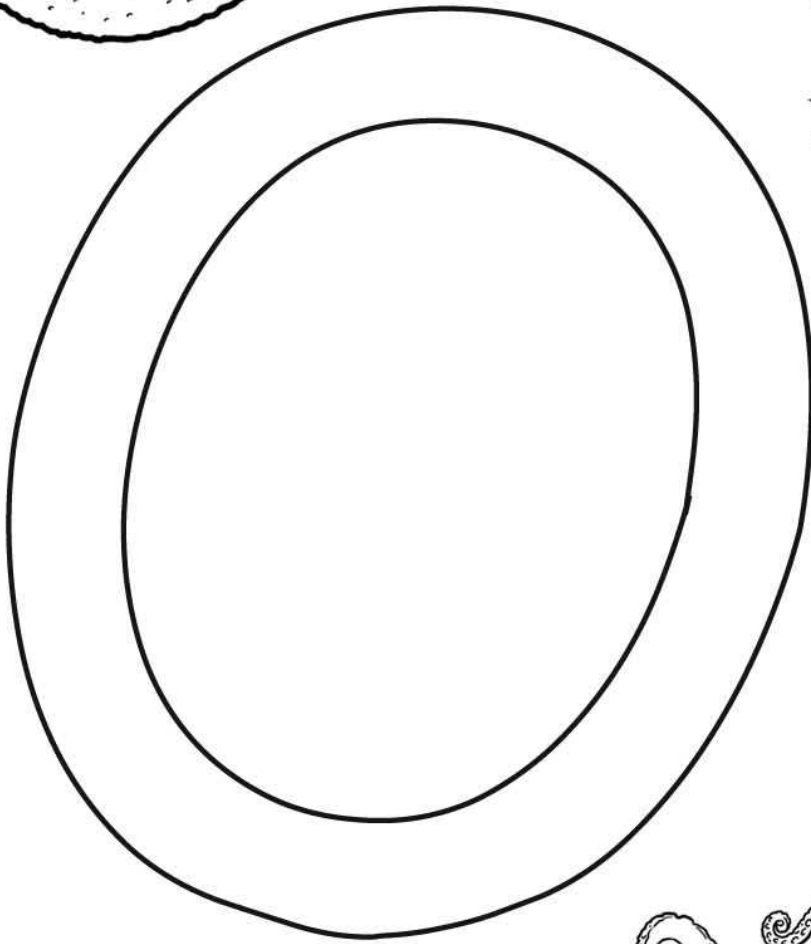
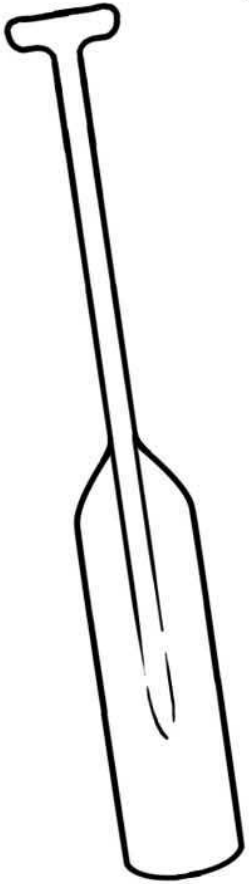
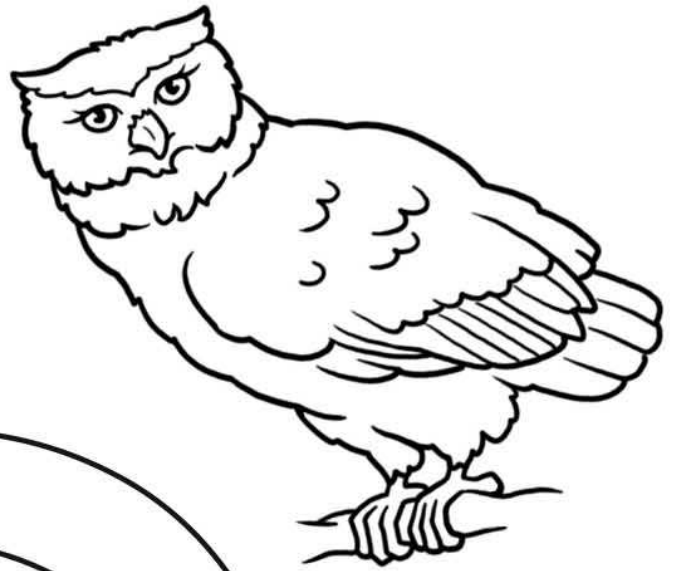
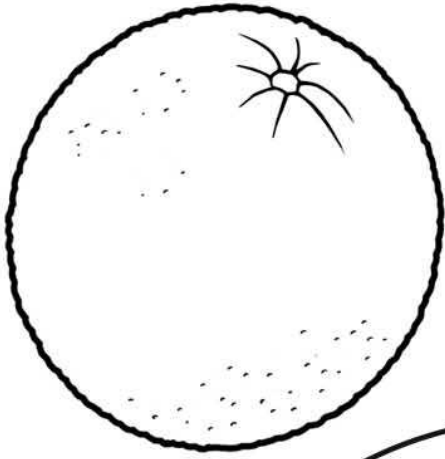

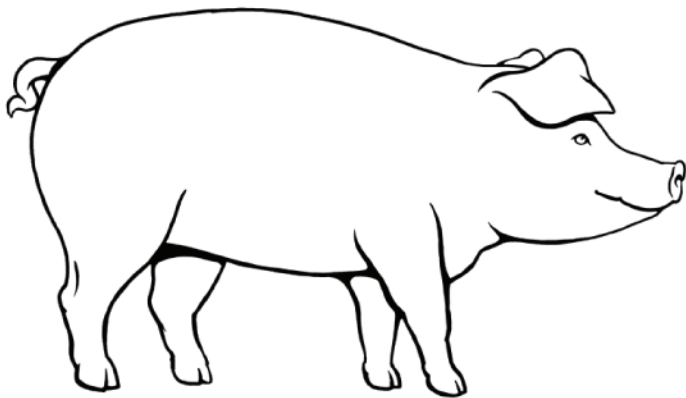
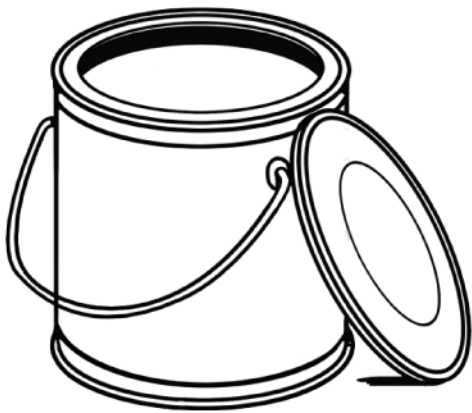
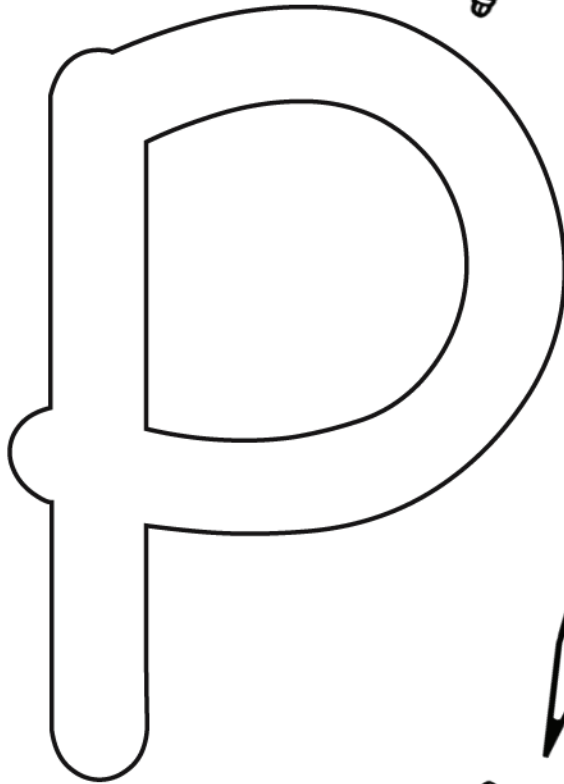
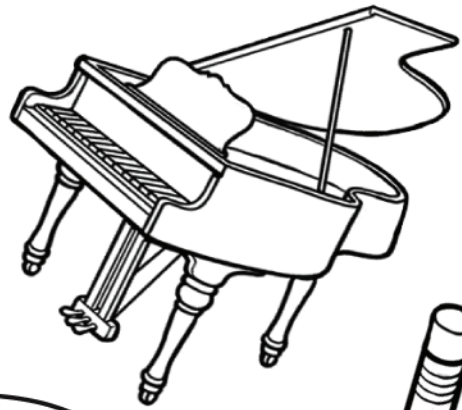

Learning Beginning Sounds: N and Q

Say the name of each picture. Color the **newt** red and the **quail** brown. Color the rest of the pictures using the color code.

Same beginning sound as **newt** = 

Same beginning sound as **quail** = 



Nn

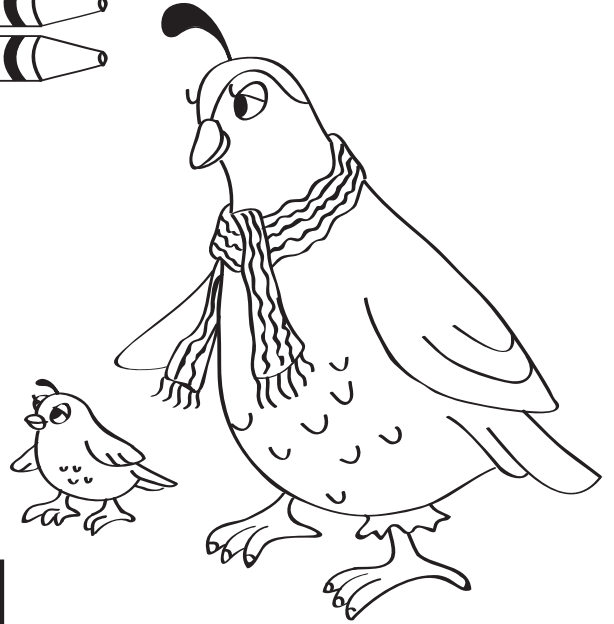

Qq

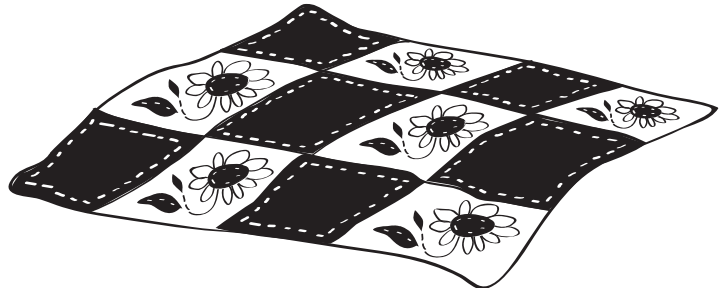
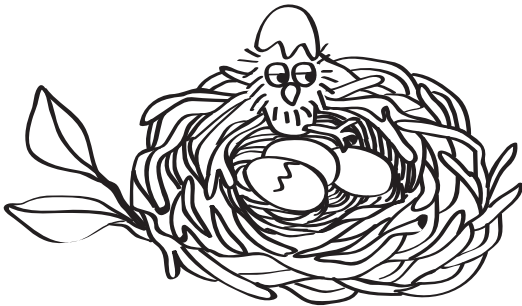
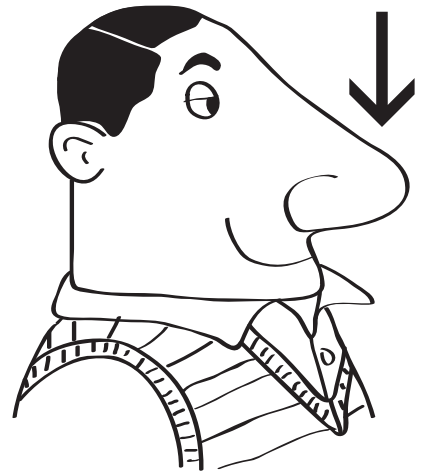
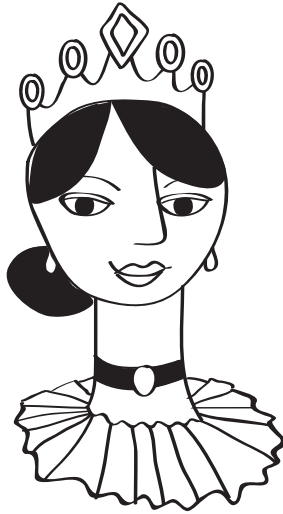
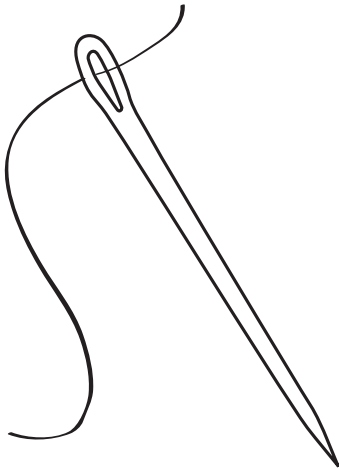

Learning Beginning Sounds: P and R

Say the name of each picture. Color the **panda** blue and the **rhinoceros** pink. Color the rest of the pictures using the color code.

Same beginning sound as **panda** = 

Same beginning sound as **rhinoceros** = 



Pp



Rr

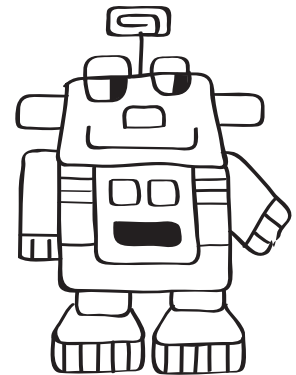
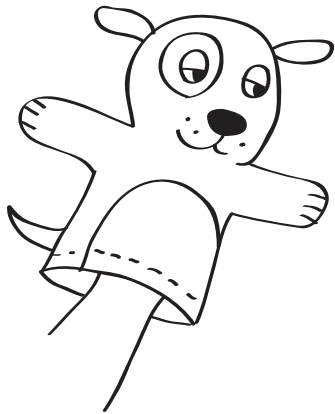

Common Beginning #3

Draw a line to match the words that have the same beginning sound.



Lemon



Paper



Pencil



Owl

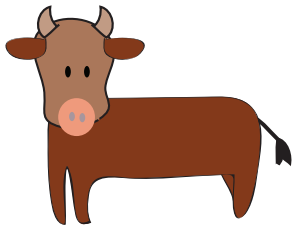

Ox



Quarter



Queen



Lion



Nest



Nut

Learning Beginning Sounds: T and S

Say the name of each picture. Color the **tiger** orange and the **sunflower** yellow. Color the rest of the pictures using the color code.

Same beginning sound as **tiger** = 

Same beginning sound as **sunflower** = 

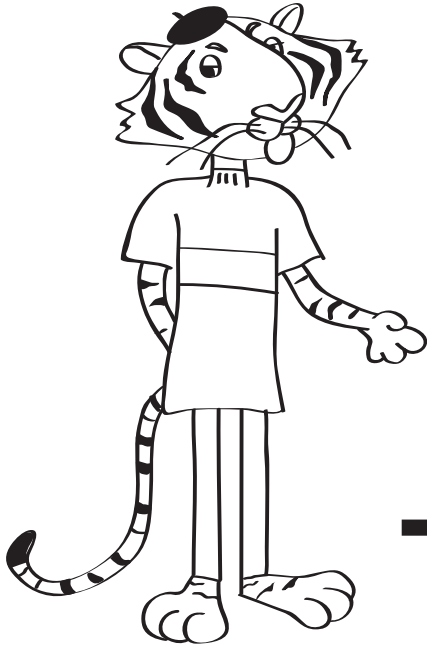

Tt

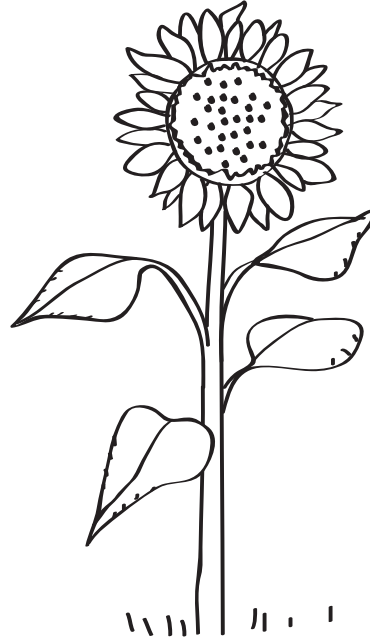

Ss

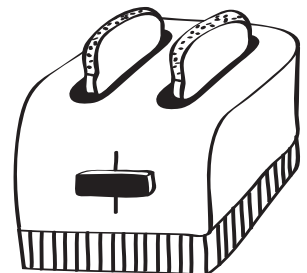
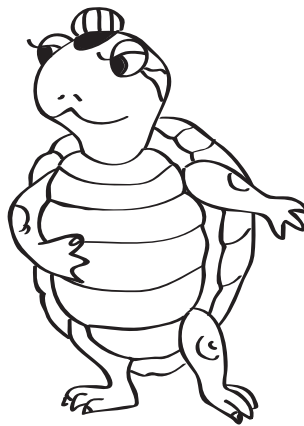
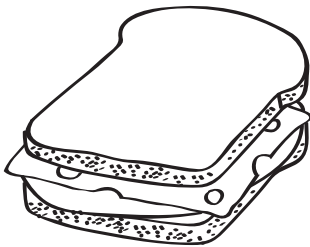

Name: _____ Date: _____

The Letter "U"

Circle the objects that begin with the letter U.

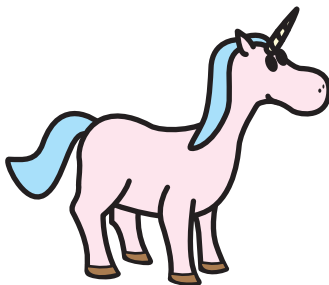
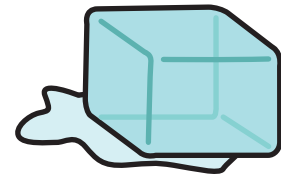
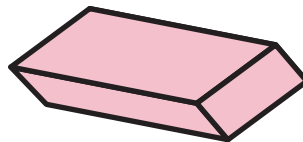
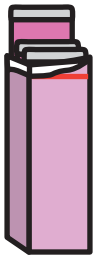
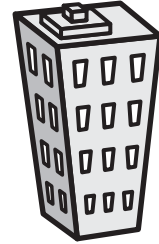
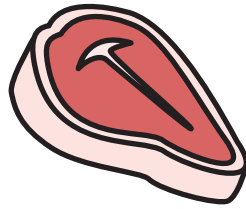
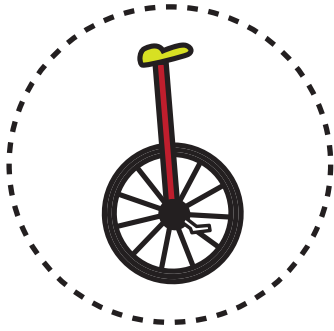

Learning Beginning Sounds: V and W

Say the name of each picture. Color the **vulture** blue and the **weasel** red. Color the rest of the pictures using the color code.

Same beginning sound as **vulture** = 

Same beginning sound as **weasel** = 

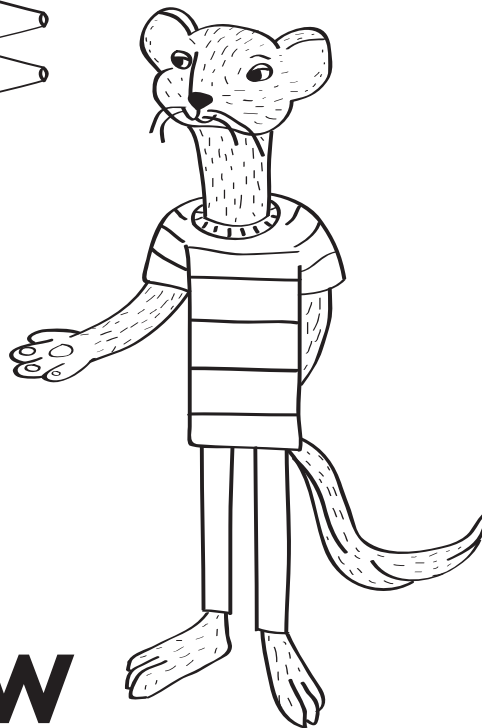

Vv

Ww

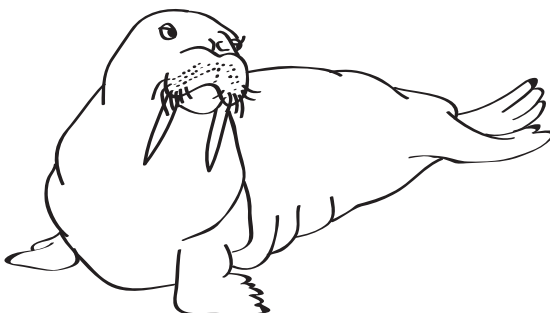
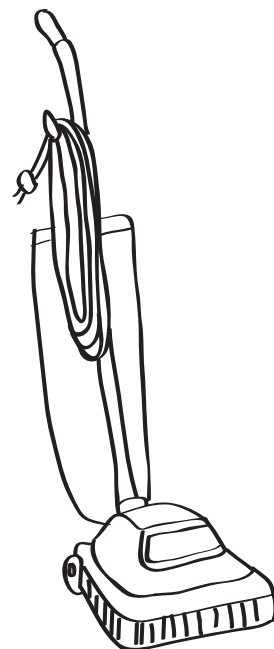
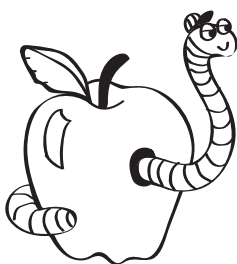
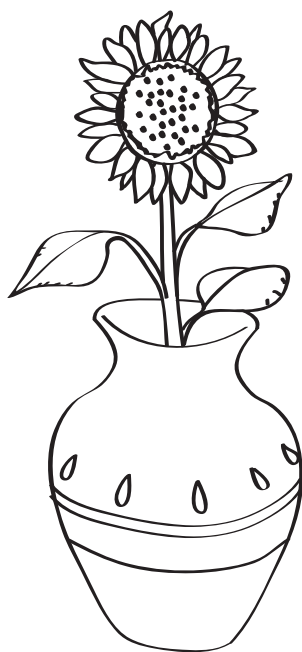

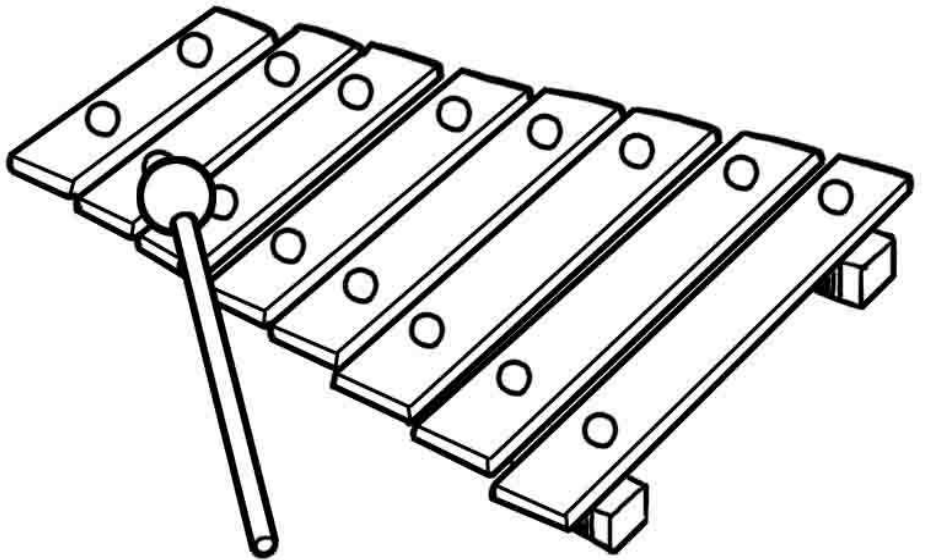
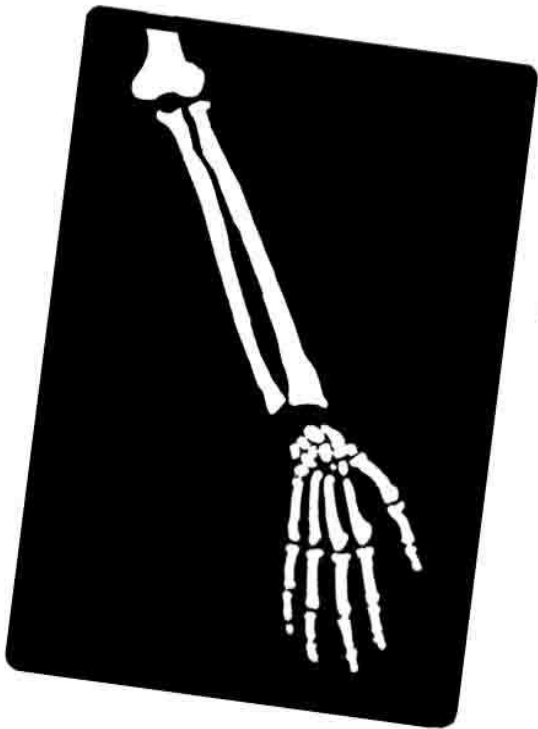
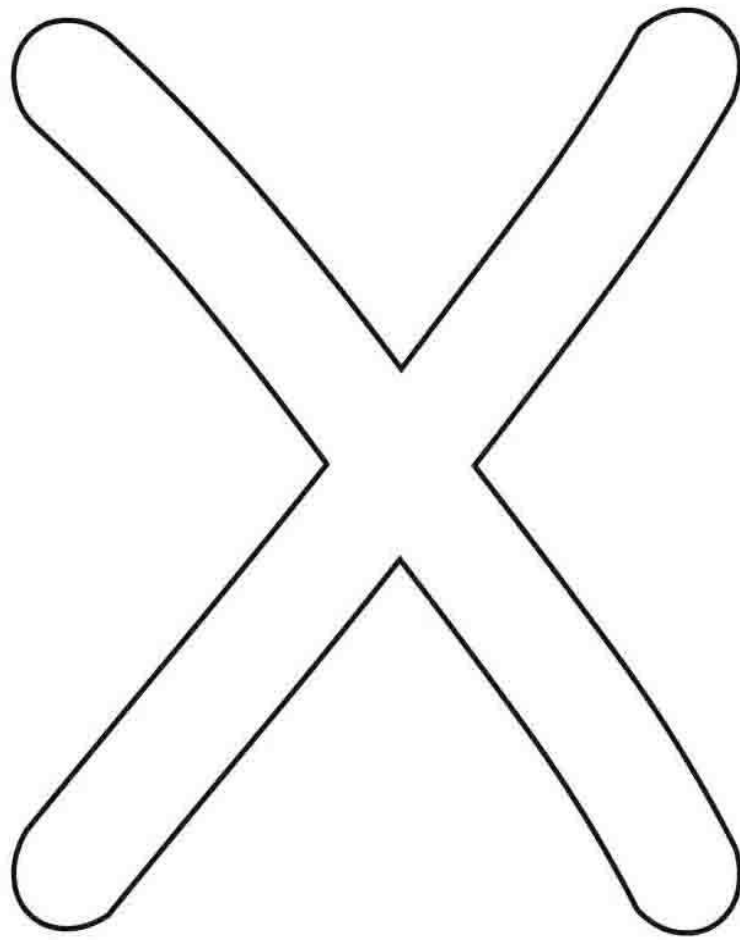

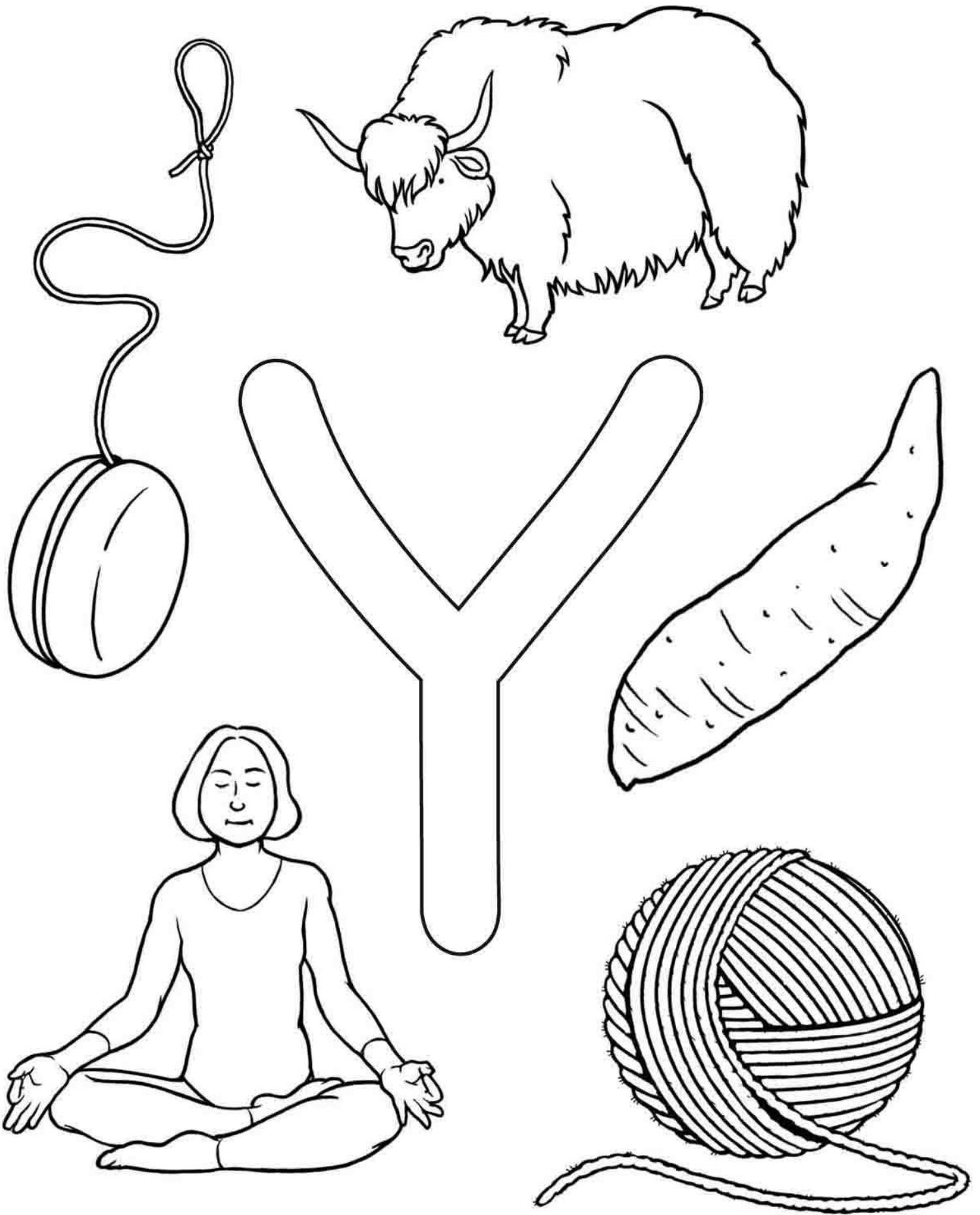

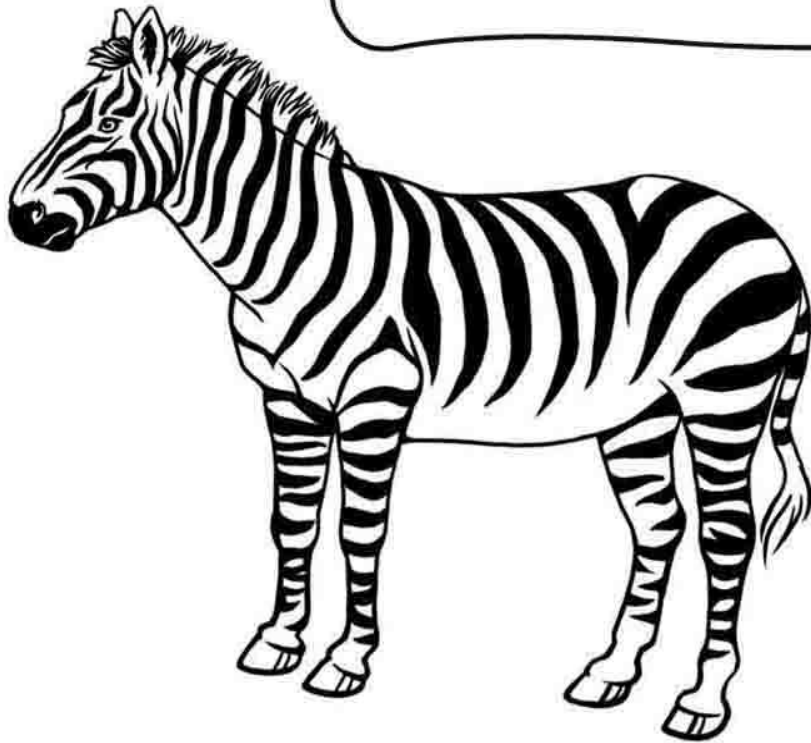
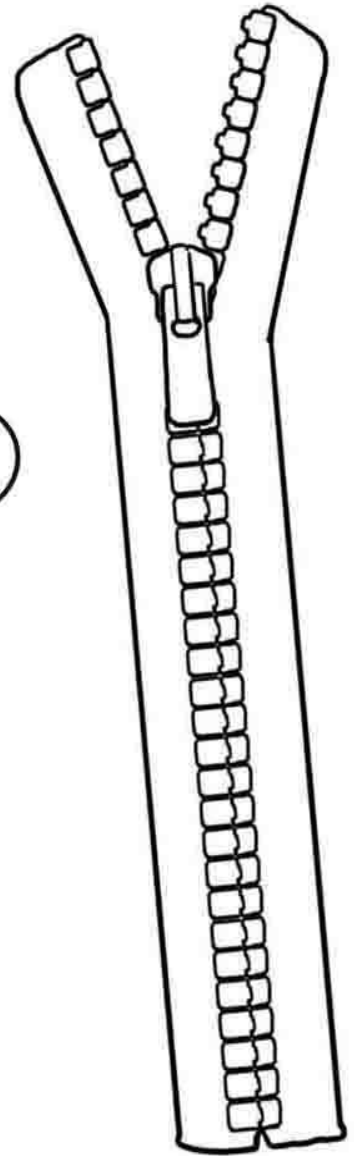
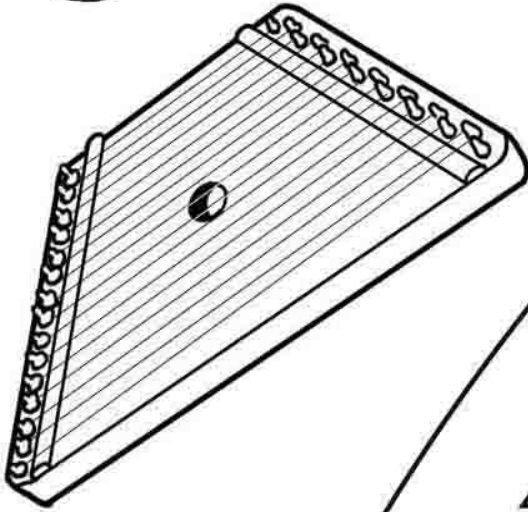
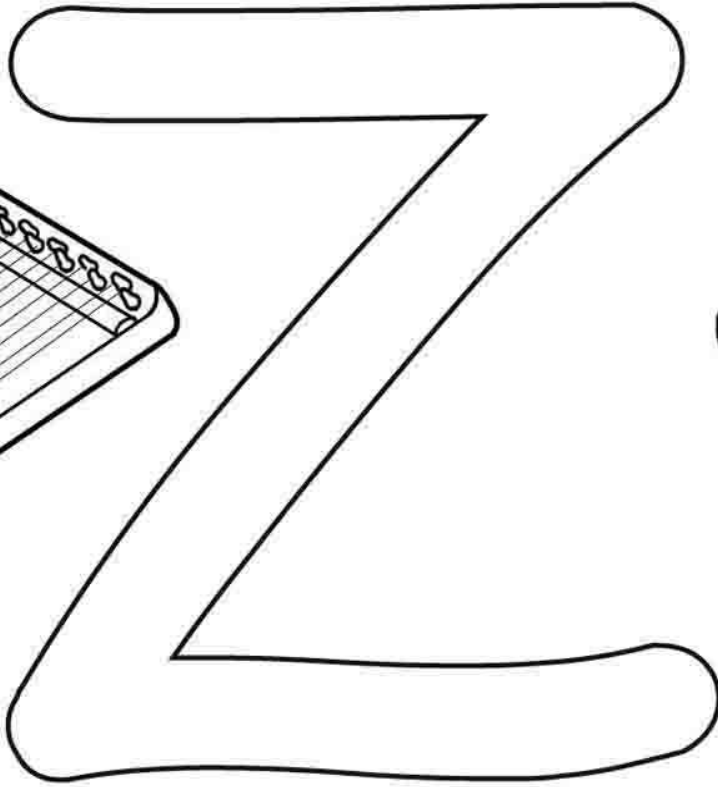
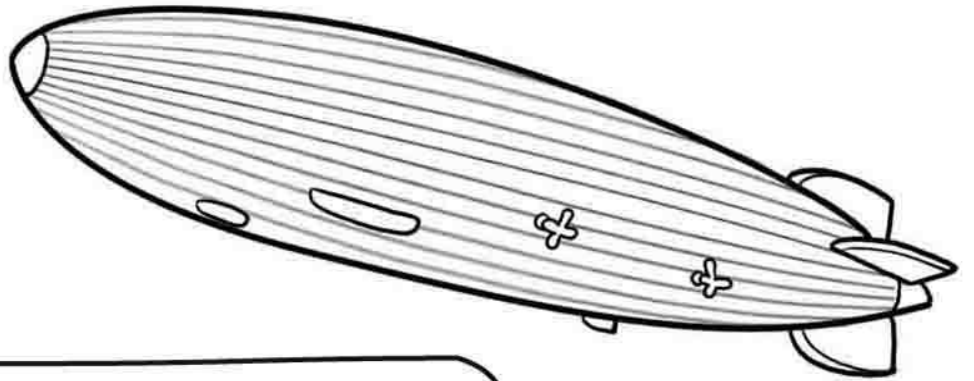
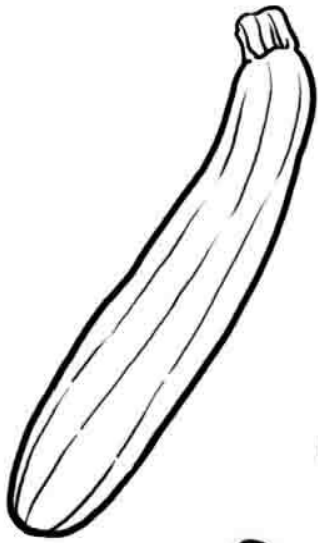

Common Beginning #5

Draw a line to match the words that have the same beginning sound.



Umbrella



Zebra



Witch

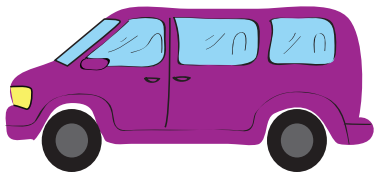

Van



Balloon



Wand



Bee

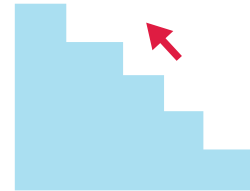

Upstairs



Vase



Zero